

*Critical Connections: Communication for  
the Future*

February 1990

OTA-CIT-407

NTIS order #PB90-182742

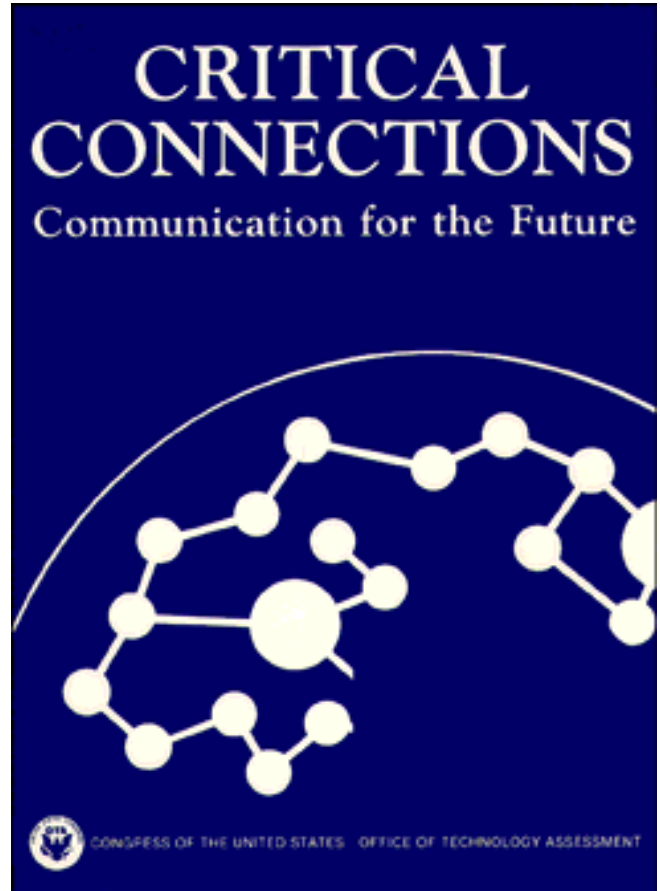

Recommended Citation:

U.S. Congress, Office of Technology Assessment, *Critical Connections: Communication for the Future*, OTA-CIT-407 (Washington, DC: U.S. Government Printing Office, January 1990).

Library of Congress Catalog Card Number 89-600713

For sale by the Superintendent of Documents  
U.S. Government Printing Office, Washington, DC 20402-9325  
(order form can be found in the back of this report)

# Foreword

The U.S. communication infrastructure is changing rapidly as a result of technological advances, deregulation, and an economic climate that is increasingly competitive. This change is affecting the way in which information is created, processed, transmitted, and provided to individuals and institutions. In addition, the lines that historically have divided domestic and international communication systems and markets are gradually disappearing. Today, decisions concerning communication systems and industries must reflect a global perspective.

While new technologies have the potential to effectively meet the needs of an information-based society, they will undoubtedly generate a number of significant social problems. In some areas they will create opportunities; in others, they may constrain activities. How these technologies evolve and are applied—as well as who will reap their benefits and bear their costs—will depend on decisions now being made in both the public and private sectors.

To provide a broad context for evaluating the impacts of new communication technologies, the House Committee on Energy and Commerce asked the Office of Technology Assessment to undertake this study. The report analyzes the implications of new communication technologies for business, politics, culture, and individuals, and suggests possible strategies and options for congressional consideration.

OTA gratefully acknowledges the contribution of the Advisory Panel, workshop participants, contractors, reviewers, and many others who provided information, advice, and assistance. However, OTA bears sole responsibility for the contents of this report.



**U** JOHN H. GIBBONS  
*Director*

## Critical Connections Advisory Panel

Christopher Burns, *Chairman*  
President, Christopher Burns, Inc.

Stanley M. Besen  
Economist  
The RAND Corp.

Robert R. Bruce  
Partner  
Debevoise & Plimpton

Lawrence Daressa  
President  
California Newsreel

Jack Golodner  
Director  
Department for Professional Employees  
AFL-CIO

Doris A. Graber  
Professor of Political Science  
University of Illinois at Chicago

Heather E. Hudson  
Director, Telecommunications Program  
McLaren College of Business  
University of San Francisco

Jeff Jeffries  
Manager  
Planning, Policy & Standards  
BP America Inc.

Steve Johnson  
Research Director  
Center for Urban Studies  
Portland State University

Anne Jones  
Attorney  
Sutherland, Asbill and Brennan

Louise McCarren  
Chittendon Bank  
(Former Chairman, Vermont Public Service Board)

Charles Miller  
Director of Public Affairs  
AT&T

Vincent Mosco  
Professor  
Mass Communication Program  
Carleton University

Eli Noam  
Commissioner  
New York State Public Service  
Commission

Adam C. Powell, 111  
Head, News and Information Programming  
National Public Radio

Wallace O. Powers  
General Network Planning Manager  
Carolina Telephone & Telegraph Co.

Howard Rheingold  
Journalist

Joseph M. Robbins  
Executive Director, BellSouth  
Bell Communications Research

Daniel T. Schiller  
Associate Professor  
Graduate School of Library and Information Science  
University of California, Los Angeles

Andrew J. Schwartzman  
Director  
Media Access Project

Robert Lewis Shayon  
Professor of Communications and Broadcasting  
Annenberg School of Communications  
University of Pennsylvania

NOTE: OTA appreciates and is grateful for the valuable assistance and thoughtful critiques provided by the advisory panel members. The panel does not, however, necessarily approve, disapprove, or endorse this report. OTA assumes full responsibility for the report and the accuracy of its contents.



# OTA Project Staff--Critical Connections: Communication for the Future

John Andelin, *Assistant Director, OTA  
Science, Information, and Natural Resources Division*

Frederick W. Weingarten, *Program Manager  
Communication and Information Technologies Program*

James W. Curlin, *Program Manager<sup>2</sup>  
Communication and Information Technologies Program*

## **Project Staff**

Linda Garcia, *Project Director*

Jean E. Smith, *Assistant Project Director*

Priscilla M. Regan, *Senior Analyst*

Susan Koch, *Analyst*

Mark Nadel, *Analyst*

David Margulius, *Research Analyst*

## **Administrative Staff**

Elizabeth Emanuel, *Administrative Assistant*

Karolyn St. Clair, *Secretary*

Jo Anne Price, *Secretary*

---

<sup>1</sup>Senior Associate as of 1/89.

<sup>2</sup>As of 4/89.

## Contractors

Raymond U. Akwule  
George Mason University

Stuart N. Brotman  
Consultant

Christopher Burns  
Christopher Burns, Inc.

Donal A. Carbaugh  
University of Massachusetts

Kan Chen  
University of Michigan

Daniel J. Czitrom  
Mount Holyoke College

Brenda Dervin  
Ohio State University

Joseph W. Duncan  
The Dun & Bradstreet Corp.

Martin H. A. Edmonds  
University of Lancaster

Deborah Estrin  
University of Southern California

David S. Evans  
Fordham University

J. D. Eveland  
Technology Applications Research

Heather E. Hudson  
University of San Francisco

Richard B. Kielbowicz  
University of Washington

Vincent Mosco  
Carleton University

Abbe Mowshowitz  
Technology Impact Research

Greta S. Nettleton  
Consultant

Howard Rheingold  
Journalist

Nathan Rosenberg  
Stanford University

Daniel T. Schiller  
University of California, Los Angeles

Jennifer D. Slack  
Consultant

Gerald Sussman  
Emerson College

Lucja Swiatkowski  
Consultant

Paul E. Teske  
Consultant

Deborah G. Tumey  
Citibank. N.A.

Langdon Winner  
Rensselaer Polytechnic Institute

## CONTENTS

	<i>Page</i>
Chapter I: Summary . . . . .	3
Chapter 2: Conceptual Framework for Analyzing Communication Issues . . . . .	29
Chapter 3: New Technologies and Changing Interdependencies in the Communication Infrastructure . . . . .	41
Chapter 4: The Impact of New Technologies on Communication Goals and Policymaking..	75
Chapter 5: Communication and Comparative Advantage in the Business Arena . . . . .	107
Chapter 6: Communication and the Democratic Process . . . . .	145
Chapter 7: Communication and the production of Culture . . . . .	181
Chapter 8: Communication and the Individual . . . . .	211
Chapter 9: Equitable Access to Communication Opportunities . . . . .	<b>243</b>
Chapter 10: Security and Survivability of the Communication Infrastructure . . . . .	275
Chapter 11: Interoperability in the Communication Infrastructure . . . . .	293
Chapter 12: Modernization and Technological Development in the U.S. Communication Infrastructure . . . . .	325
Chapter 13: Jurisdictional Issues in the Formulation and Implementation of National Communication Policy . . . . .	361
Appendix A: Acronyms . . . . .	389
Appendix B: Reviewers . . . . .	390
Appendix C: List of Contractor Reports . . . . .	393
Appendix D: List of Acronyms . . . . .	394

**Chapter 1**

# **Summary**

## CONTENTS

	<i>Page</i>
INTRODUCTION .....	3
CHANGING COMMUNICATION INFRASTRUCTURE .....	3
OPPORTUNITIES AND CONSTRAINTS PRESENTED BY NEW COMMUNICATION TECHNOLOGIES .....	4
Communication and Comparative Advantage in the Business Arena .....	5
Communication and the Democratic Process .....	6
Communication and the Production of Culture .....	8
Communication and the Individual .....	8
POLICY ISSUES AND CONGRESSIONAL STRATEGIES .....	10
Equitable Access to Communication Opportunities .....	10
Security/Survivability of the Communication Infrastructure .....	12
Interoperability of the Communication Infrastructure .....	14
Modernization and Technological Development of the U.S. Communication Infrastructure .....	16
Jurisdiction in the Formulation and Implementation of National Communication Policy .....	18
THE NEED FOR A NATIONAL VISION OF THE ROLE OF COMMUNICATION .....	18
Market Vision-Communication as a Market Commodity .....	21
Economic Vision-Communication as a Springboard for National Economic Growth and Development .....	22
Social Vision-Communication as Social Infrastructure .....	<b>23</b>
CONCLUSION .....	23

### *Figures*

<i>Figure</i>	<i>Page</i>
1-1. Congressional Strategies and Options To Address Access to Communication Opportunities.....	13
1-2. Congressional Strategies and adoptions To Address Security/Survivability of the Communication Infrastructure .....	15
1-3. Congressional Strategies and Options To Address Interoperability/Coordination of the Communication Infrastructure, .....	17
1-4. Congressional Strategies and Options To Address Modernization of the Communication Infrastructure .....	19
1-5. Congressional Strategies and Options To Address Jurisdictional Issues in Communication Policymaking .....	20

## INTRODUCTION

The U.S. communication system is changing dramatically. Recent advances in information storage, processing, and transmission technologies, occurring in a newly deregulated and increasingly competitive economic climate, are rapidly reconfiguring the Nation's communication infrastructure. New computer and communication technologies have already transformed the regulation and market structure of the industry, altering the way information is created, processed, transmitted, and provided to individuals and institutions.

Changes are also taking place at the international level. Because the new technologies encourage the flow of, and the demand for, information products and services across national borders, they are wearing away the lines that historically have divided domestic and international communication systems and markets. Communication is one of the fastest growing sectors in the international marketplace, and international conglomerates are increasingly being formed to provide products and services both at home and abroad.

New technologies hold promise for a greatly enhanced system that can meet the changing needs of an information-based society. At the same time, however, these technologies will undoubtedly generate a number of significant social problems. How these technologies evolve, as well as who will be affected positively or negatively, will depend on decisions now being made in both the public and private sectors. This study provides a context for evaluating these decisions.

## CHANGING COMMUNICATION INFRASTRUCTURE

The communication infrastructure is the underlying structure of technical facilities and institutional arrangements that supports com-

munication via telecommunication, broadcasting, film, audio and video recording, cable, print, and mail. Although the "public works" connotation of infrastructure may lead some to think of the term as public facilities, most of the U.S. communication infrastructure is held by private individuals and firms.

---

---

**With digitalization all of the media become translatable into each other—computer bits migrate merrily—and they escape from their traditional means of transmission . . . If that's not revolution enough, with digitalization the content becomes totally plastic—any message, sound, or image may be edited from anything into anything else.**

Stuart Brand  
*The Media Lab:  
Inventing the Future at MIT, 1988.*

---

---

The communication infrastructure helps shape communication through the nature of its technical facilities and the ways in which those facilities are organized and made available to users. Communication, in turn, is central to the business, political, and cultural life of a society, and to the individuals that comprise it.

The societal effects of the Nation's communication infrastructure are determined by its overall technical capabilities, their availability, and their patterns of use. Three aspects of the infrastructure are relevant:

1. the technical characteristics of the communication facilities themselves;
2. the economic interdependencies among producers, distributors, and users of communication facilities; and
3. the policy goals and rules that define and constrain these relationships.

The following advances in communication technologies are generating changes in all three aspects:

- improved technical performance in transmission, encoding, decoding, storage and retrieval, and content production, at decreasing costs;
- convergence of communication functions, as well as communication products and services;
- decentralization of intelligence and control throughout communication systems with the development of software-driven and software-defined communication facilities;
- the availability of some discrete communication services that were previously provided only as part of a package (unbundling);
- increased portability of products and services;
- improved ease of use through better software design;
- increased networking capability; and
- increased capability to target messages to specific individuals or groups.

These technological trends and their socioeconomic impacts are unraveling the existing U.S. communication system, creating new opportunities, players, and problems. In the wake of these changes, fundamental questions are being raised about how to organize communication systems to promote innovation, maximize the benefits of competition, and capture economies of scale and scope. Moreover, the fact that the various media are converging as a result of digitization raises basic questions about the rules that govern access to communication technologies. Above all, questions are being raised about the goals of the communication system, as well as how, and by whom, future communication policy decisions should be made.

If Congress is to affect the future of the U.S. communication infrastructure, it will need to

address these questions, perhaps by revisiting and reevaluating the Nation's basic goals for communication. To successfully renovate the Nation's communication policy, Congress will need to gain the support of, and coordinate its efforts with, an ever-increasing number of players in a variety of decisionmaking arenas. The task is a critical one, notwithstanding the difficulties involved in such an undertaking. **If Congress fails to act decisively and generate broad support, the opportunity to make deliberate choices about new communication technologies—and about the nature of American society itself—will be overtaken by rapid technological advances, the hardening of stakeholder positions and alliances, and the force of international developments and events.**

### **OPPORTUNITIES AND CONSTRAINTS PRESENTED BY NEW COMMUNICATION TECHNOLOGIES**

To determine the role that government might play in the realm of communication, Congress will need to consider the opportunities that new communication technologies offer society, as well as the obstacles that prevent those opportunities from being realized. The stakes are high—for businesses, the democratic process, culture, and individuals—because using communication effectively provides a strategic advantage in achieving goals. Taking advantage of new communication technologies in one of these four realms may, however, conflict with their use in the other three. For example, providing communication systems that meet the security standards of business and government may limit the extent to which the same systems can be used for research and collaborative efforts. Also, the business use of communication storage and processing technologies to target customers may create problems of information overload and of securing privacy for individuals.

### *Communication and Comparative Advantage in the Business Arena*

Although the United States has fared reasonably well over the past few years, many observers are beginning to express serious reservations about the future of the U.S. economy and its ability to compete in an increasingly global environment. They point out that recent economic growth in the United States has been fueled by foreign capital, and that the growth of manufacturing exports has been slower than imports. Experts note that the continued decline

of the U.S. economic position in world trade is having serious consequences for labor. Pointing to the recent success of the Japanese model of business organization, some have even suggested that, to be competitive, the United States may also need to develop and adopt new ways of organizing for production.

Many of those who are concerned about the U.S. economy look to the communication and information sectors to provide the impetus for future growth. This focus on “telematics” is not surprising, given the trend toward a greater role



*Photo credit: Bell Atlantic*

Mobile telephones allow personnel to communicate with their offices and clients while on the road. New cordless phones that can be carried on a belt are also being introduced to facilitate communication for those who work outside or away from their desks.



for information in advanced industrial societies, and the fact that the United States has traditionally had a comparative advantage in this area. Communication is regarded not only as a source of economic growth, but also as a means of reconfiguring work relationships to make them more effective.

Given the increased dependence of American businesses on information and its exchange, the competitive status among businesses and in the global economy will increasingly depend on the technical capabilities, quality, and cost of the communication facilities on which they can rely. **The emergence of new technologies provides a unique opportunity for businesses and nations to create comparative advantages in a changing world economy. Failure to exploit these opportunities is almost certain to leave many businesses and nations behind.**

How well American businesses are able to take advantage of these opportunities will depend on:

- the compatibility and interconnectivity of communication and information systems,
- the laws concerning the use of information,
- economic and technical resources,
- corporate culture and organizational structure,
- developments in international trade and international telecommunication regulation,
- domestic regulatory policies, and
- the availability of a skilled work force.

**It is clear that if government wants to promote the effective use of new communication technologies to improve the economy, it must find ways to deal with issues such as standards and the standards-setting process, education and training, corporate organization and labor relations, and international trade.**

The widespread deployment of new communication technologies for economic advantage may also raise equity issues. To use telecommu-

nication competitively, many businesses are finding it necessary to create their own private communication networks. But the costs of such systems are high, in terms of both organizational and financial resources. Thus, many small companies cannot afford to take advantage of the new technologies. **To the extent that the government looks to new communication technologies to foster U.S. economic growth and development—and wishes its small and medium-sized companies to participate in this—it may need to take special steps to facilitate those companies’ use of these technologies.**

### *Communication and the Democratic Process*

Since communication is central to all political activities, the way in which the U.S. communication infrastructure evolves is likely to affect the future of the American political system. New technologies can create new communication pathways, allowing new gatekeepers to mediate political dialog. For this reason, political “outsiders” have historically viewed communication technologies as an effective means for becoming political “insiders.” Those already in positions of authority have sometimes sought to structure laws and behavior in order to limit access to new communication technologies.

---

---

**A new form of “politics” is emerging, and in ways we haven’t yet noticed. The living room has become a voting booth. Participation via television in Freedom Marches, in war, revolution, pollution, and other events is changing everything.**

Marshall McLuhan,  
Quentin Fiore, Jerome Agel  
*The Medium is the Massage, 1967.*

---

---

Today, many people regard the technological advances in communication as a means for enhancing both citizen participation and government performance. The interactive, online capabilities of new technologies, it is claimed, could allow citizens to directly voice their opinions on



Photo credit: C-SPAN

C-SPAN provides regular coverage of congressional floor debates and committee hearings via its cable network. Citizens can interact directly with program participants in Washington by telephone.

public issues, as well as conduct an ongoing dialog with other citizens, elected representatives, and government bureaucrats. Moreover, the targeting capabilities of the technology could improve the ability of citizens to identify like-minded people, create new interest groups, raise financial and political support, and track the activities of—as well as lobby—government officials.

Government agencies can improve their efficiency by using technologies that facilitate both networking and data storage and reprocessing. For example, the ability to identify specific groups can be used to improve law enforcement, immigration control, and the detection of fraud, waste, and abuse in welfare systems. Real-time communication among government agencies, through the use of online systems, could also make government operations more efficient and effective.

Other people are more skeptical of the effect of new technologies on government and politics. They view them as a means by which those

already in positions of power or authority can further solidify their influence. For instance, they claim that online, interactive political dialogs will generate information about individuals that could be used by government to monitor the activities of groups or individuals. Moreover, they are concerned lest the targeting of specialized groups lead to greater fragmentation of the body politic. Some also fear that new communication capabilities will not be used to improve the substance of political debate, but rather to promote personality instead of policy.

In government and politics, as in the past, the impact of new communication technologies will be determined to a large extent by the rules, norms, and skills that govern access to them. The emergence of new political gatekeepers, and who they are, will be of critical importance. As information is treated more and more as a commodity to be bought and sold in the marketplace, the traditional political gatekeepers—including political parties, the traditional press, and government agencies—are being

replaced by new kinds of political gatekeepers, such as political consultants, media consultants, private sector vendors, and international newscasters. Whereas the traditional gatekeepers are governed by political rules and norms, the new gatekeepers are guided to a greater extent by market criteria. **Where markets dominate the allocation of communication resources--such as information, a speaking platform, or access to an audience--political access may become increasingly dependent on the ability to pay. Thus, the economic divisions among individuals and groups may be superimposed on the political arena.**

On another level, new international players, such as multinational news agencies, are replacing government officials as gatekeepers in areas such as international diplomacy. Depending on the extent of this development, the ability of the Nation to exercise its sovereignty through traditional diplomatic channels may be compromised.

### *Communication and the Production of Culture*

Communication is the process by which culture is developed and maintained. Information, the content of communication, is the basic source of all human intercourse. Throughout history, information has been embodied and communicated in an ever-expanding variety of media, including spoken words, graphics, artifacts, music, dance, written text, film, recordings, and computer hardware and software. Together, these media and their distribution channels constitute the web of society that guides the direction and pace of social development. From this perspective, the communication of information permeates the cultural environment and is essential to all aspects of social life.

The new information and communication technologies provide many opportunities to enhance our culture by expanding the infrastructure for information-sharing and exchange. Communication can be used to generate greater amounts of information and new cultural forms, to make this knowledge more accessible, and to

provide it in more convenient and suitable ways. Because these technologies are decentralized and widely available, they can provide the opportunity for more people to become actively involved in creative activities.

However, **it is likely that many of the cultural opportunities afforded by new communication technologies will not be realized without further government involvement or structural changes in the communication industry.** Recent communication history illustrates, for example, that technological developments leading to a greater number of transmission channels do not necessarily lead to

---

---

**A panoply of electronic devices puts at everyone's hand capacities far beyond anything that the printing press could offer. Machines that think, that bring great libraries into anybody's study, that allow discourse among persons a half-world apart, are expanders of human culture.**

Ithiel de Sola Pool  
*Technologies of Freedom, 1986.*

---

---

increases in the diversity or quality of information content and programming. Equally important in determining the kind of content produced are the economic relationships among the key players in the communication arena. If, in the future, government wishes to encourage more people to become active in creating their own cultural environment, economic incentives may need to be considered. Moreover, efforts will need to be made not only to assure that people can access a broad variety of information and cultural content, but also that they have the skills and resources necessary to create, package, and distribute information.

### *Communication and the Individual*

Emerging technologies promise to provide individuals with opportunities to increase their personal autonomy, enhance their sense of connection to others, and, in general, enable

greater accomplishments and self-fulfillment. These same technologies, however, could produce the opposite outcomes, contributing to personal isolation, increased dependency, and the loss of privacy. How new technologies will affect individuals will depend in part on the rules that Congress adopts to govern access to information and the new communication technologies. For example, government decisions about access to the data that are collected in the course of economic transactions will affect individual privacy rights. Also, decisions about what kinds of information services telephone companies can provide will affect the speed at which, and the extent to which, fiber technologies and the information services they make available can be deployed to the home.

---

**The medium, or process, of our time--electric technology—is reshaping and restructuring patterns of social interdependence and every aspect of our personal life.**

Marshal McLuhan,  
Quentin Fiore, and Jerome Agel  
*The Medium is the Massage, 1967.*

---

The Nation's communication infrastructure is becoming increasingly complex. Individuals or firms are becoming more responsible for designing the various communication resources they require. In order to take the greatest advantage of new technologies, people will need to be more technically skilled and have access to better "navigational tools" (means to help people access the systems, analogous to today's TV guides or telephone books). Navigational tools will be crucial in making individuals aware of communication opportunities, and in providing guidance in the use of these systems. **The communication capabilities of individuals—their "literacy" in the languages, commands, and structures of future systems—will largely determine the benefits they receive.**

**The extent to which access depends on the ability to pay will also determine the impact of**

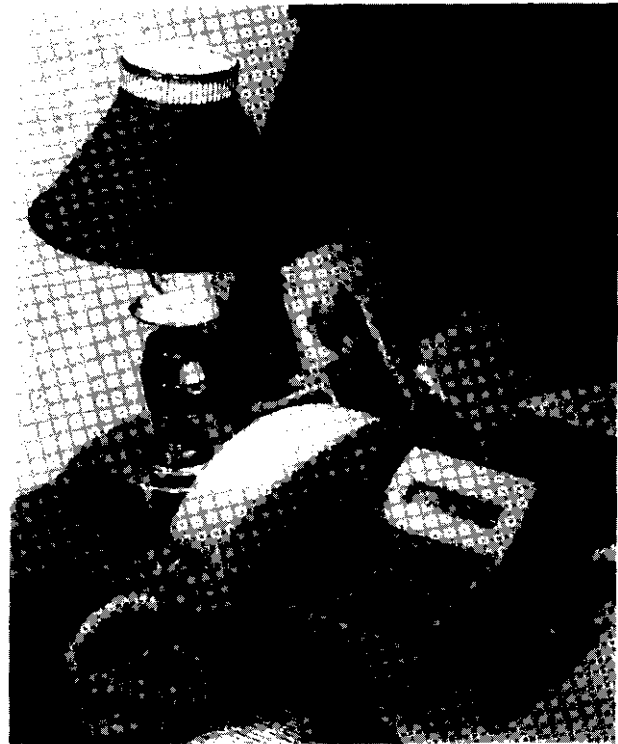

*Photo credit: Bell Atlantic*

New caller identification terminals use a small electronic screen to display the telephone number from which an incoming call was placed.

new communication technologies on individuals. In telephony, for example, there is general agreement that services should be provided universally and it has been clear what those services should be. Until recently, achieving consensus was relatively simple because the range of telephone services that could be offered was narrow. The needs of all users could thus be equated and the cost of service could be shared; therefore, the price that individuals were charged for service could be set relatively low. With shared usage it was possible to allow some users to subsidize others.

**Today, the concept of providing universal service on a common, shared network, as well as the system of subsidies that supported it, is breaking down. Major questions are being raised about the kinds of communication services that are needed, and the degree to which all users have equivalent needs that**

**can be served in the same fashion. Thus, the question of what should constitute universal service in an information age needs to be readdressed.** Depending on how this question is answered, the United States could be faced with a two-tiered communication system, which would give rise to issues of equitable access. For example, if businesses view their needs as unique and decide to develop their own private networks, as some are doing now, there may be insufficient revenues available to support an advanced public network to serve all individuals. Under such circumstances, the costs and prices of services would be higher, to the extent that there are diminished economies of scale and scope.

New technologies will not only affect how people access information, but also how information impinges on people's lives. The pace of technological change has created confusion about the appropriate standards for information use. For instance, what privacy protections should individuals expect? While eager to take advantage of new electronic shopping opportunities, many people are unaware that transaction data generated in the process can be collected, processed, and used in the future as tools for marketing or even surveillance. While embracing new ways to access information for their own use, many individuals may find it difficult to cope with the fact that others, in turn, now have much greater access to them.

## **POLICY ISSUES AND CONGRESSIONAL STRATEGIES**

Although new communication technologies afford a myriad of socioeconomic opportunities, many of these opportunities may go unrealized. Some may fail to materialize for lack of foresight, public demand, or political will. Others may founder because of poor circumstances and timing. Some opportunities can only be fulfilled at the expense of others.

**The need to make trade-offs among opportunities is particularly great in communication because communication lies at the**

**heart of social activity.** For example, the growing use of private branch exchanges (PBXs) and high-speed data transmission lines to create private business telephone networks may, if carried too far, drain the pool of financial and human resources available to the public switched telephone network. This could limit the extent to which the communication infrastructure can serve other economic, political, and social goals. **Making such trade-offs is likely to be more contentious in the future because the strategic value of information is increasing in business, politics, culture, and individual development and personal growth.**

Analyzing the potential for conflict among new communication opportunities, OTA identified five major areas in which public policy issues are likely to arise:

1. equitable access to communication opportunities,
2. security and survivability of the communication infrastructure,
3. interoperability of the communication infrastructure,
4. modernization and technological development of the communication infrastructure, and
5. jurisdiction in formulating and implementing national communication policy.

These are characterized below, along with congressional strategies and options for addressing them.

### ***Equitable Access to Communication Opportunities***

**The** opportunities for people to participate in economic, political, and cultural life depend on their ability to access and use communication and information services. Individuals need skills and tools to locate the communication pathways, information, and audiences in a timely fashion and in an appropriate form. Unequal access to communication resources leads to unequal advantages, and ultimately to inequalities in social and economic opportunities.

OTA found that **changes in the U.S. communication infrastructure are likely to broaden the gap between those who can access communication services and use information strategically and those who cannot.**

Moreover, the people most likely to be adversely affected are those whom the new communication technologies could help the most—the poor, the educationally disadvantaged, the geographically and technologically isolated, and the struggling small and medium-sized business.

OTA identified a number of factors that are likely to contribute to access problems. For example, technological advances, deregulation, and increased competition have led to the reduction of a number of communication subsidies, and to changes in the way in which many communication services are operated and financed. For some, these developments are increasing the cost of purchasing communication services. The overall costs of identifying, locating, and applying relevant information in a timely fashion are on the rise. Costs are increasing because there is a larger volume of information for individuals and businesses to cope with, and because the tools and systems needed to deal with the larger volume are becoming more complex. Access to communication services is also likely to be more limited in the future if trends toward increased mergers and vertical integration of communication-related industries

---

**Ownership in every major medium now includes investors from other media—owners of newspapers, magazines, broadcasting, cable systems, books and movies mixed together. In the past, each medium used to act like a watchdog over the behavior of its competing media . . . But now the watchdogs have been cross-bred into an amiable hybrid, with seldom an embarrassing bark.**

Ben H. Bagdikian,  
*The Media Monopoly*, 1987.

---

continue at their present pace, and if media gatekeepers, in selecting content, are increasingly guided by market criteria. It is more difficult to establish appropriate rules for access in this rapidly changing environment. **New technologies are challenging traditional regulatory criteria, magnifying the confusion and inconsistencies that surround first amendment rights, and dismantling the traditional definition of universal service.**

In addressing these problems, Congress may have to move in some new, and untried, directions. Past policies to promote access to both communication and information focused on assuring access to transmission media. Barriers to access were reduced by structuring the rights of those who owned the transmission systems (for example, by limiting the number of broadcast stations that an individual can own), or by structuring the prices that users paid for transmission service (as in the case of telephone and postal rates). Using transmission media as the leverage for access was the chosen regulatory approach, given first amendment proscriptions limiting government's role in regulating content. It was, moreover, a relatively effective approach because transmission media represented the major bottleneck to communication access.

Today, this is no longer the case. Although transmission bottlenecks still exist (as, for example, in the local telephone exchange), new kinds of bottlenecks are also appearing. Some of these have more to do with the identification, production, and application of information content than with its transmission. These bottlenecks occur because people lack, for example, the necessary technical skills, navigational tools, and access to production facilities. To effectively promote communication access in the future, government policies will need to focus more on these newly emerging barriers to access.

Congress could pursue six different strategies to improve access to communication services:

1. influence the means by which communication services are funded and financed,
2. structure the prices at which communication services are offered,
3. provide direct government support for users to access information and communication paths,
4. regulate and/or redefine the rights of media owners,
5. influence the level and availability of the tools and resources required to access communication and information services, and
6. assume a more proactive role to assure robust debate on issues of public importance.

These strategies, and the options that each might entail, are summarized in figure 1-1. An analysis of the benefits and disadvantages of adopting any of these options is provided in chapter 9.

### *Security/Survivability of the Communication Infrastructure*

Adequate security and survivability are essential characteristics of an acceptable communication infrastructure. However, establishing a secure and survivable infrastructure requires trade-offs against access, cost, and ease of use. Although most people probably support the general goal of security and survivability, there is disagreement with respect to the level of security and survivability needed, and the extent to which other communication goals should be sacrificed to achieve these goals.

OTA identified a number of factors and developments that can affect the security and survivability of the communication infrastructure. The increased reliance of business and government on communication and information systems makes them more vulnerable to system failures. The number and variety of problems that may threaten the security or reliability of communication systems are greater than in the past. Communication systems are more complex, decentralized, and interdependent. Thus, it is more difficult to achieve security and survivability goals.

In the past, issues surrounding the security and survivability of the communication infrastructure were not important to most Americans. Such problems were generally addressed behind the scenes in private businesses and government. These issues are becoming less containable. OTA found that **security and survivability goals are becoming more important and more visible; but it is also becoming more difficult to make the trade-offs in communication policy required to achieve these goals.** Stakeholders' views differ about how these trade-offs should be made and what policies should be pursued. In addition, government agencies are not adequately organized to resolve security and survivability issues and achieve security goals.

**Congress may need to play a more active role in resolving competing security goals and in promoting the security of both private and public communication systems.** The Federal Government's role in this area was traditionally limited to assuring that the Nation's communication infrastructure was secure and reliable enough to meet the needs for defense and emergency preparedness. Today, however, the public's stake in the security and survivability of communication systems goes well beyond defense and disasters. Given the dependence of many corporations on communication and information systems, there are now larger social costs from major failures in private systems. For example, in November 1985, a computer problem in the Bank of New York's offices prevented the company from completing an exchange of government securities. This fault in the system not only cost the bank \$1.5 to \$2 million after taxes; it also forced the bank to borrow \$24 billion from the Federal Reserve System. In this sense, communication security problems occurring in the private sector are much more difficult to contain. As the role and value of communication increase, the likelihood that security problems will spill over into the public sector also increases.

Figure 1-1--Congressional Strategies and Options To Address Access to Communication Opportunities

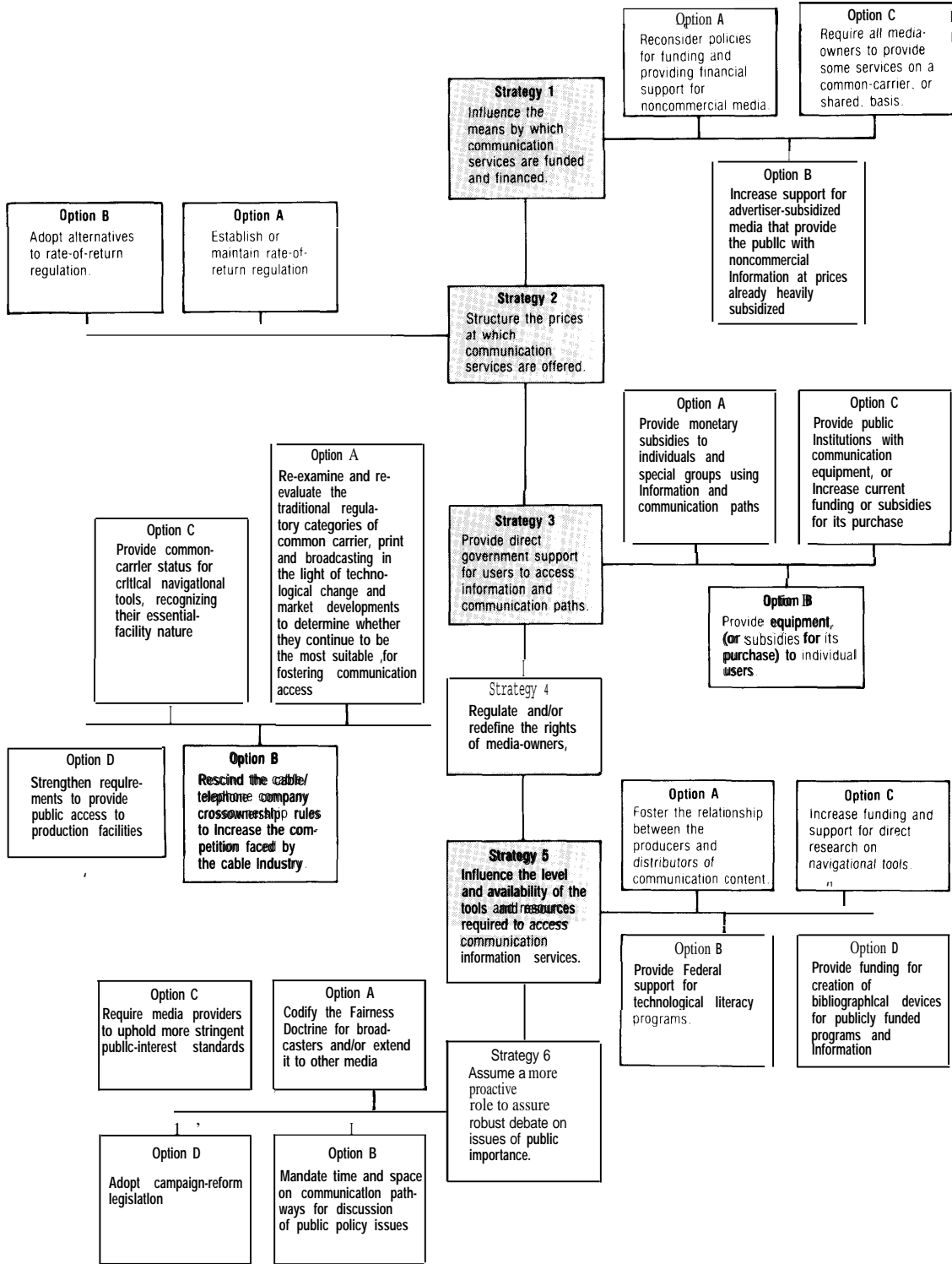



Congress could pursue six different strategies to address the security and survivability of the communication infrastructure:

1. undertake further study and analysis of changing security and survivability needs of the communication infrastructure;
2. facilitate the transfer of information about security and survivability, garnered in the public agencies, to the private sector;
3. establish security and survivability requirements for key industrial sectors;
4. provide special emergency facilities for private sector use;
5. improve coordination of survivability planning; and
6. increase activity geared to preventing security breaches.

These strategies, and the options that each might entail, are summarized in figure 1-2 and analyzed in chapter 10.

### ***Interoperability of the Communication Infrastructure***

Communication systems are, by definition, designed to interconnect. Thus interconnection, or interoperability, is critical to the communication infrastructure. The more interoperable a communication system is, the more connections it can provide and the more accessible it will be to everyone on an equal basis. Interoperability provides for redundancy, thus improving system survivability. Interoperability is important not only in a technical sense, but in an administrative sense as well. To be most useful, the infrastructure needs to be transparent to users in terms of the services offered.

Interoperability also has a downside. It can make a communication system more vulnerable to breaches in security by broadening access. To the extent that interoperability requires standardization, it can retard technological innovation and slow development of the system.

In the past, there were few problems in achieving adequate interoperability within the communication infrastructure. In the area of telephony, AT&T provided end-to-end service and system interconnection. The government played an important role in mass media and information processing, assuring, when necessary, that there was adequate standardization.

**Interoperability is likely to become more of a technical and administrative problem in the future. Not only will the need for interoperability be greater, but achieving it is also likely to be more difficult.** Five developments have contributed to the difficulties of ensuring interoperability. First, the growing importance of information and communication as a strategic resource attaches greater importance to the interoperability of any communication infrastructure. Second, many of the traditional ways that interoperability has been achieved have been eliminated. Third, the globalization of the economy has led to a greater need for international standards and the extension of standards-setting efforts to the international arena. Fourth, the number and variety of players in the standards-setting process have increased, as have the costs and stakes of adopting standards. Fifth, the standards that need to be set are more complex (e.g., anticipatory, process standards such as open systems interconnection [OSI]<sup>1</sup> and integrated services digital networks [ISDN]).<sup>2</sup>

Although the overall circumstances in which particular government strategies are likely to be the most appropriate can be generalized, these will have to be tailored to each case. Congress could pursue five different strategies to address the interoperability of the communication infrastructure:

1. support research to provide better data and a more analytic rationale for standards-setting decisions;

---

<sup>1</sup>OSI is an **architecture** for computer networks and a family of standards that permits data communication and processing **among diverse** technologies.

<sup>2</sup>ISDN is a **network that provides integrated switch and facility digital** connections between user-network interfaces to **provide or support a range** of different communication services.

**Figure I-2--Congressional Strategies and Options To Address Security/Survivability of the Communication Infrastructure**

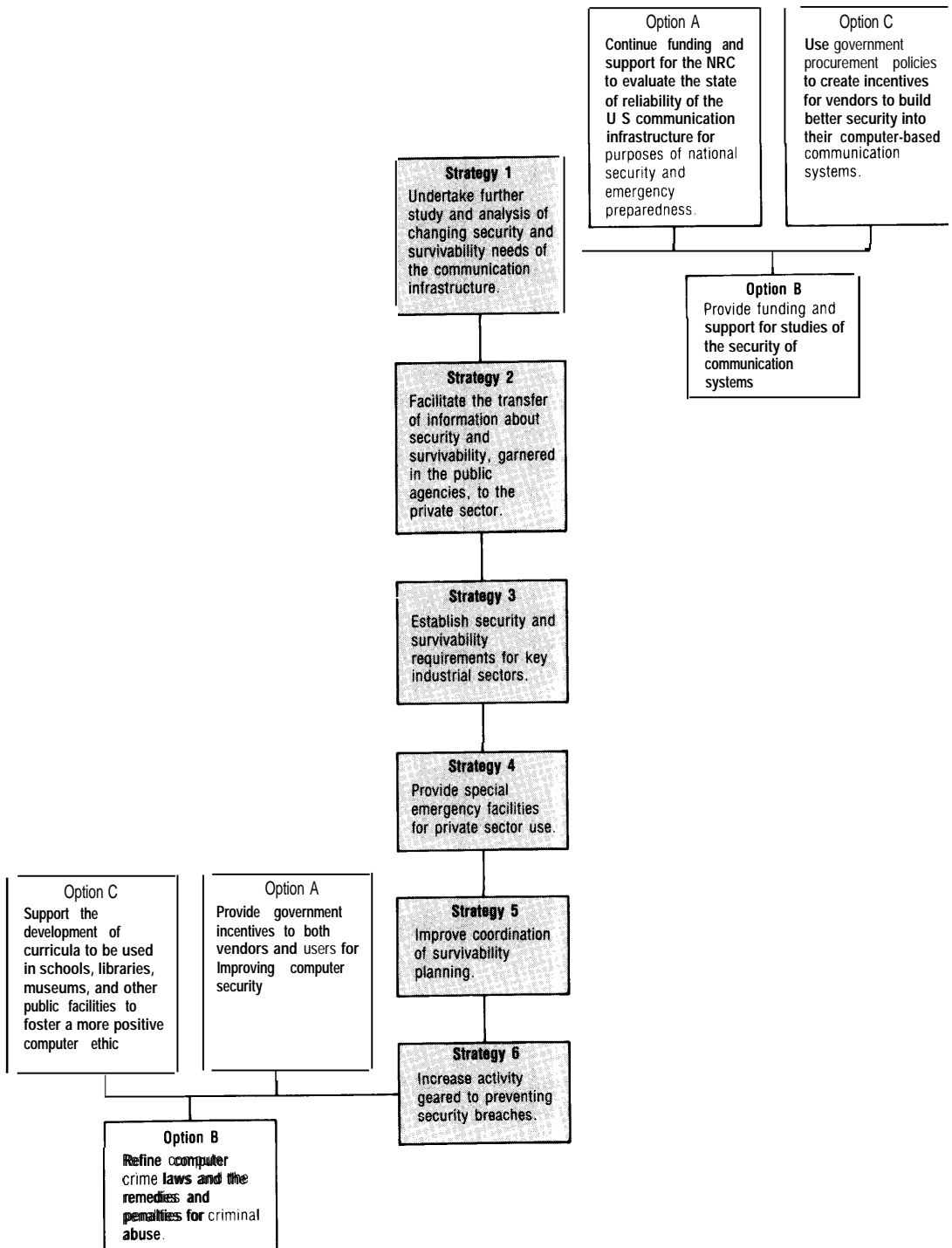

2. allow for the emergence of market solutions, either in the form of gateway technologies or through the setting of de facto standards;
3. indirectly influence the standards-setting process by providing assistance and guidance to foster the setting of standards;
4. influence the setting of particular standards by providing incentives or imposing sanctions; and
5. mandate industrywide standards.

These strategies, and the options that each might entail, are summarized in figure 1-3 and analyzed in chapter 11.

OTA identified three specific cases where interoperability—or the lack of it—will have major implications for U.S. communication policy. These are related to the establishment of ISDN, the evolution of OSI, and the creation of an open network architecture (ONA).<sup>3</sup> In considering whether Congress should take additional steps to encourage the standards-setting process in these three cases, certain factors need to be kept in mind. These are outlined, together with corresponding policy responses, in chapter 11 (tables 11-1, 11-2, and 11-3).

### ***Modernization and Technological Development of the U.S. Communication Infrastructure***

As the role of information increases in all aspects of life, additional demands will be made on the communication infrastructure. Some of these demands may increasingly be in conflict. The communication infrastructure will have to be more competitive in providing communication at the international level. To adequately meet and balance all of these communication needs, the U.S. communication infrastructure must make maximum use of advances in communication and information technologies. It will need to do so in the most efficient and cost-effective manner. The most critical policies are those related to research and development,

capital investment, and human resource development.

Historically, the United States has set the international pace for technological development in communication and information technologies. However, in the late 1970s, technological advances began to outstrip the pace of change within the public shared telecommunication network, finally leading to the divestiture of AT&T and the emergence of a number of competing communication networks and service vendors. Although competition has clearly contributed to growth and economic activity in the communication sector, OTA identified a number of factors that suggest that in a competitive, global environment, the United States may find it increasingly difficult to retain its world technological leadership.

The first factor is the development of international competition resulting in an increase in the pace of technological advancement in communication infrastructure. The second is the high capital costs of modernizing the communication infrastructure and uncertainties as to how it will be financed. The potential inefficiencies that could result from lack of national coordination and planning for communication represent the third factor. The fourth is the proactive role played by foreign governments in modernizing their communication systems. The fifth factor is the fractionated U.S. decisionmaking process. The sixth is the limits of human resources for communication.

Congress could pursue three strategies to address the modernization of the communication infrastructure:

1. involve the government directly in the development, planning, financing, and coordination of the communication infrastructure;
2. provide indirect incentives for modernizing and developing the communication infrastructure; and

---

<sup>3</sup>ONA is the overall design of a carrier's basic network facilities and services to permit all users of the basic network to interconnect to specific basic network functions and interfaces on an unbundled and equal access basis.

Figure 3--Congressional Strategies and Options To Address Interoperability/Coordination of the Communication Infrastructure

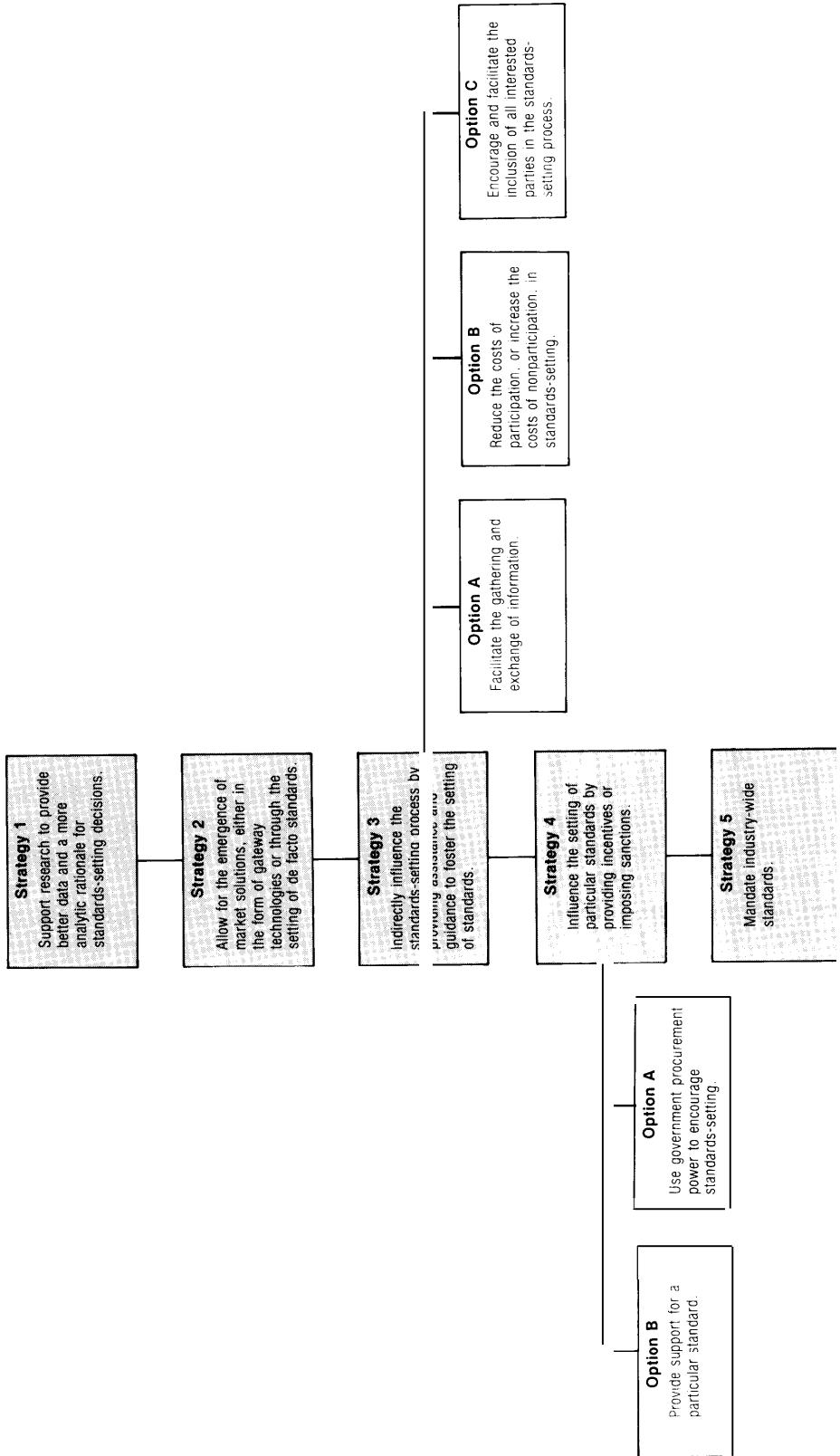

3. create a regulatory environment that is more conducive to the modernization of the communication infrastructure.

These strategies, and the options that each might entail, are summarized in figure 1-4 and analyzed in chapter 12.

### *Jurisdiction in the Formulation and Implementation of National Communication Policy*

**Rapid technological advances in communication, coupled with the unraveling of a traditional regulatory framework in the United States, have given rise to a highly uncertain communication policy environment.** Occurring at a time when the role of information is particularly important, these developments will affect everyone. Each individual has a high stake in the outcome of current communication policy debates. An exceptionally equitable, efficient, and effective policymaking process will be required to find appropriate solutions to the complex and thorny policy dilemmas that society faces, and to reconcile the conflicts that will inevitably arise among competing—even if meritorious—interests. At the very least, the allocation of authority and the rules of the game will need to be clear and perceived by the public to be legitimate.

As the United States participates in the increasingly global information economy, the lack of a coherent and coordinated national communication policymaking process is likely to severely hinder the development and execution of a strategy for dealing with the myriad of communication issues that will emerge. The American policy process has always been somewhat disorderly because of the important role of federalism and the separation of powers in the U.S. political system. However, its untidiness has been particularly noticeable in communication policy—a fact that has already prompted two Presidential policy boards (in 1951 and 1968) to recommend the creation of a central

agency to formulate overall communication policy.

OTA findings suggest that a number of factors are likely to make these problems worse in the future. These include the shift of communication decisionmaking from political institutions to the marketplace, the expanding links between communication policies and other socioeconomic policies, the increased interdependence of national and international communication policies, and the emergence of large users—often multinational corporations—as key players in communication decisions.

Congress could pursue four basic strategies to address jurisdictional issues in communication policymaking:

1. take the lead in establishing communication policy priorities and in allocating organizational responsibilities accordingly;
2. establish an ongoing organizational mechanism, outside of Congress, to resolve policy inconsistencies and jurisdictional disputes;
3. provide an interagency and/or interjurisdictional mechanism for coordinating communication policy and resolving jurisdictional issues; and
4. establish an institutional basis for facilitating coordination and cooperation among government agencies, industry providers, and communication users.

These strategies, and the options each might entail, are summarized in figure 1-5 and analyzed in chapter 13.

## **THE NEED FOR A NATIONAL VISION OF THE ROLE OF COMMUNICATION**

The choice of congressional policy strategies and options will depend primarily on how Congress views the role of communication in 21st-century America and what communication goals it will set for the Nation. This study provides Congress with a roadmap for matching

Figure 1-4—Congressional Strategies and Options To Address Modernization of the Communication Infrastructure

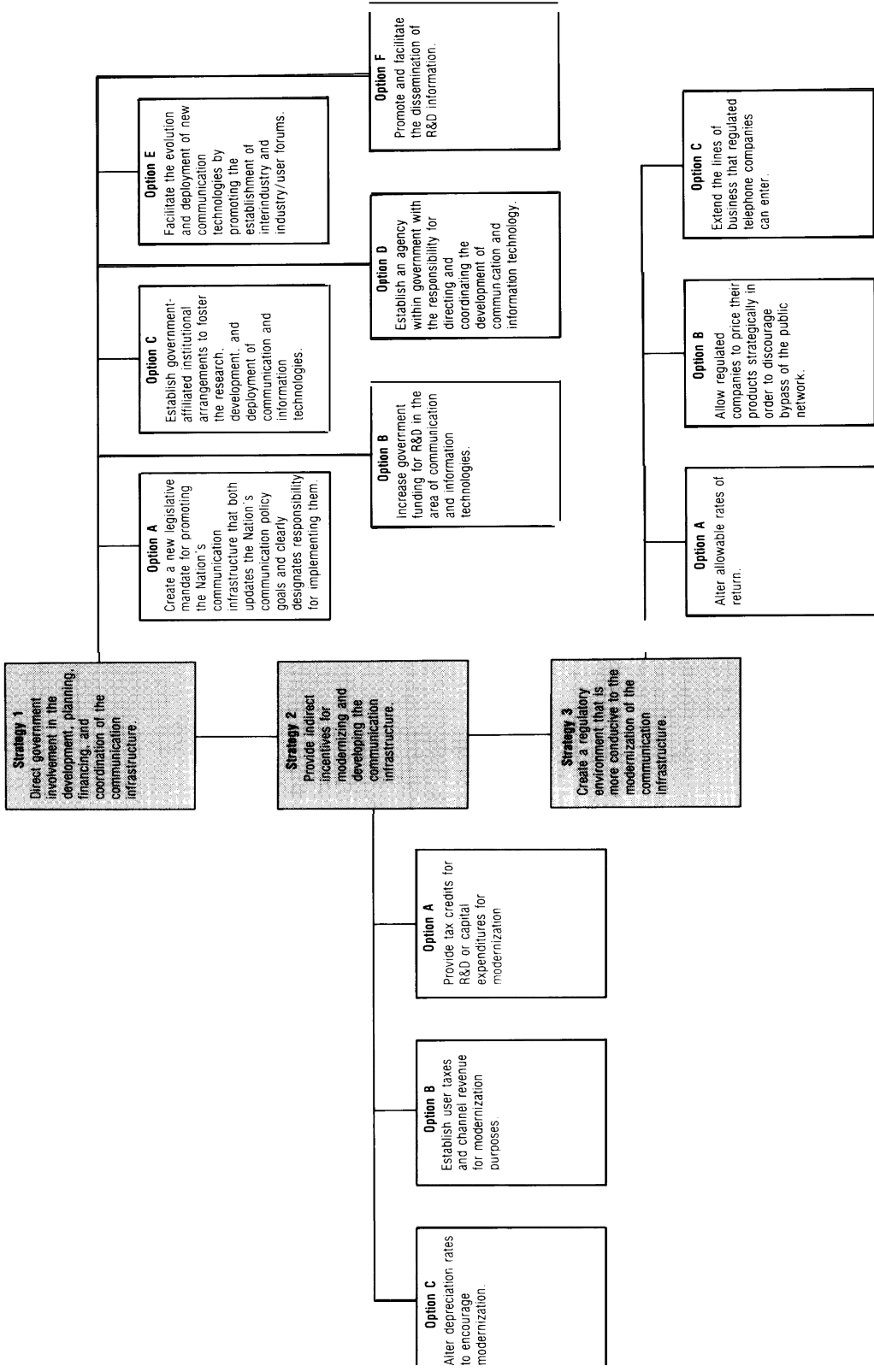

**Figure I-5-Congressional Strategies and Options To Address Jurisdictional Issues in Communication Policymaking**

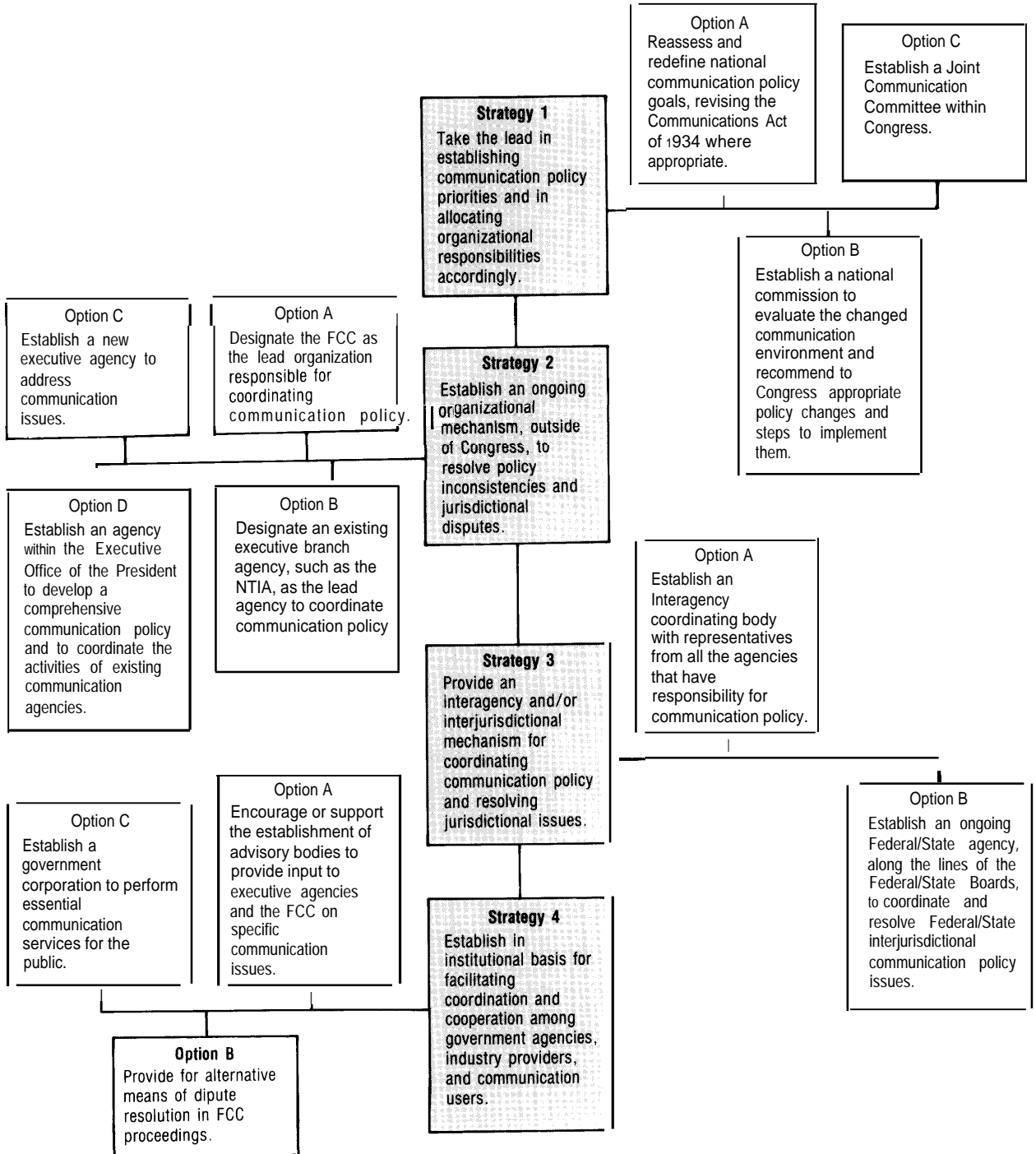

---



---

**There is nothing more difficult to plan, more doubtful of success, nor more dangerous to manage than the creation of a new order of things.**

Machiavelli, 1513.

---



---

U.S. communication policy with consistent strategies and policy options, based on the five issues discussed above. Three possible visions are presented here:

1. communication as a market commodity,
2. communication as a springboard for economic growth and development, and
3. communication as a basic societal infrastructure.

These visions are purposely sharply drawn to provide clear alternatives.

### *Market Vision-Communication as a Market Commodity*

This vision reflects the view that communication is an end in itself, and that communication services should be treated like any other commodity that can be bought and sold. This view is illustrated at the extreme by former FCC Chairman Fowler's statement equating television sets and toasters, which, he said, leads to the conclusion that the marketplace is the most appropriate mechanism for determining the production, distribution, and use of television sets as well as other communication devices and services.

Those with this perspective include many antitrust economists and lawyers who place a high value on economic efficiency, viewing its attainment as the measure of an optimal social outcome. They claim that through market competition the criterion of efficiency is most likely to be met. Supporting this viewpoint are many new participants in the communication system (for example, resellers of communication services, system integrators, and gateway and information vendors) who, eager to take advantage of

the new technologies to add value to existing products and services, want a chance to enter the market and compete. Many business users who operate their own private communication networks also subscribe to this point of view. So, too, would consumer advocates who, viewing communication primarily as a commodity, are concerned most about the cost of service to consumers.

Viewing communication policy from this perspective, the ideal role for the Federal Government would be to intervene to correct or ameliorate situations where market failures can be clearly identified. Members of this group might disagree, however, about the means of government intervention. While some favor trying new or experimental regulatory approaches such as price-cap regulation for telephone companies, others insist that, where real competition is lacking, adequate protection for users and potential competitors requires traditional rate-of-return regulation. With these differences in mind, the following congressional strategies are consistent with the vision of communication as a commodity, and the government's perceived role:

- reexamining and readdressing regulatory categories in terms of the market structure of various industries as it is affected by technological advances, and strengthening regulatory procedures where required;
- refining computer crime laws and penalties;
- allowing for the emergence of market solutions to problems of incompatibility;
- influencing the standards-setting process indirectly by providing assistance and guidance to foster standards-setting;
- providing indirect incentives for modernizing and developing the communication infrastructure;
- providing for some technology research and development; and
- phasing out some existing regulatory agencies and integrating others.



### ***Economic Vision--Communication as a Springboard for National Economic Growth and Development***

This vision reflects concerns about the state of the U.S. economy and the decline of the U.S. competitive position in an increasingly global economy, and calls for the promotion of communication technologies and the modernization of the communication infrastructure. Proponents view communication not just as an end in itself, but also--and more importantly--as *the* means for bringing about renewed economic growth and development in the United States. Some are concerned lest other nations—viewing the modernization of their communication infrastructures as part of their overall national industrial policies--employ new communication technologies to gain a competitive advantage over the United States.

Most who hold this view would agree that the communication infrastructure can serve a number of social goals. However, because of the growing intensity of international economic competition, some would argue that, where societal goals conflict, using communication to foster national economic goals should take precedence. They would point out that, if the United States fails to achieve economic success, it will no longer have the wherewithal to accomplish other goals.

Such arguments have been made by a number of government officials who deal with trade and national industrial policy issues. This viewpoint is also reflected in some recent government reports calling for a revision of the Modified Final Judgment<sup>4</sup> and alternatives to rate-of-return regulation. Most of the regional Bell operating companies that stand to benefit from these changes also use this argument when presenting their case to government. Some users in small and medium-sized businesses who

cannot afford to develop their own communication networks, but who view communication as a strategic resource, might also be inclined to favor the view of communication as the “springboard for economic growth.”

Proponents of this view call on the Federal Government to play a more active role in promoting technological development and the modernization of the communication infrastructure. While they might differ on how to promote communication technologies for economic ends, the congressional strategies consistent with this overall viewpoint include:

- providing direct government support for users to access information and communication paths;
- undertaking further study and analysis of the changing security and survivability needs of the communication infrastructure;
- providing special emergency facilities for private sector use;
- improving coordination of survivability planning;
- increasing activities geared to prevent security breaches;
- supporting research to provide better data and a greater analytic rationale for standards decisions;
- while allowing for market solutions to standards problems, providing for a government role when necessary to achieve overall, national economic goals;
- providing indirect incentives to encourage investment in modernization;
- removing regulatory barriers that discourage modernization; and
- taking the lead in establishing communication policy priorities, and in allocating organizational responsibilities accordingly.

---

<sup>4</sup>The Modified Final Judgment was the 1982 consent agreement entered into by AT&T and the Department of Justice, and Subsequently approved by the U.S. District Court for the District of Columbia. AT&T retained most long-distance operations and terminal equipment. The Bell operating companies were spun off and reorganized into seven regional holding companies. They were permitted to offer local monopoly services, as well as toll services within their restricted operating territories. They could provide new terminal equipment, but could not engage in manufacturing.

### *Social Vision-Communication as Social Infrastructure*

This view emphasizes the linkages between communication, human activity, and social structures. It focuses on the relationship between access to communication and services, and access to power, wealth, and position in society. Hence, in weighing communication policy choices, it places great weight on equity. Because proponents of this vision hold that communication can serve as a means as well as an end, they often propose communication-related solutions to many of society's problems.

This viewpoint is currently not well represented in the communication policy community. There are, however, many in the academic community—specially in departments of communication and social science—who strongly advocate this point of view. There are also many educators, health providers, government officials, and citizen activists who see in communication a potential for assisting them in solving their problems. Communication providers who could benefit from significant economies of scale and scope by expanding and integrating their services would also support this view.

Those who view communication as a means to accomplish societal ends historically have tended to grow in number (or at least to become more vocal) as technological advances in communication give rise to new aspirations. This was so for the penny press, telegraph, telephone, radio, and television; and it is likely to be so as the Nation moves forward in an age of information and advanced communication.

For those who view communication as social infrastructure, the role for government is to ensure not only that needed technologies and communication services exist, but also that they are available to everyone and will serve all social purposes on an equitable basis. Thus, they strongly advocate—in addition to many of the strategies identified for the Economic Vision above-congressional strategies that are more directly designed to improve access. These would include, for example:

- influencing the means by which communication services are funded and financed;
- structuring the prices at which communication and information services are offered;
- regulating and redefining the rights of media-owners;
- influencing the level and availability of the tools and resources required to access communication and information services; and
- assuming a more proactive role to assure robust debate on issues of public importance.

Whereas those who adhere to the Economic Vision might want to limit government's role if it appeared to create additional burdens for business and industry, those who view the infrastructure more generically might not be so inclined. Considering all social goals to be more or less equivalent, adherents of this Social Vision might also favor the following strategies:

- establishing security and survivability standards for communication systems in key industrial sectors;
- influencing the setting of particular standards by providing direct incentives or by imposing sanctions where necessary to achieve social ends; and
- mandating industrywide standards where necessary to achieve social ends.

## CONCLUSION

Before selecting communication policy strategies for the future, Congress will first need to consider how it views the role of communication in society. This report provides a context for these considerations by analyzing and reviewing the changes taking place in the communication infrastructure. It identifies the range of societal opportunities that new communication technologies afford, and the problems and issues to which these new technologies give rise. If Congress can agree on a consistent vision of communication goals, many policy choices will naturally follow. What is first required is a vision, and a commitment to pursue it.

**Part I**

**Changing Communication  
Infrastructure,  
Goals, and Policymaking**

**Chapter 2**

# **Conceptual Framework for Analyzing Communication Issues**

## CONTENTS

	<i>Page</i>
INTRODUCTION .....	29
DEFINING KEY TERMS .....	<b>30</b>
The Nature of Technology .....	30
The Definition of Communication and Other Related Terms .....	31
A CONCEPTUAL FRAMEWORK FOR ANALYZING POLICY	
ISSUES ENGENDERED BY NEW COMMUNICATION TECHNOLOGIES .....	34
Existing Conceptualizations .....	34
A Model to Guide the Present Analysis .....	34
ORGANIZATION OF THE REPORT .....	37

### *Figures*

<i>Figure</i>	<i>Page</i>
2-1. Shannon/Weaver Model of Communication .....	32
2-2 <sub>0</sub> Communication Process .....	33
2-3. Interactive Model of Communication and Society .....	35

# Conceptual Framework for Analyzing Communication Issues

## INTRODUCTION

New technologies create new potential and new opportunities that change our notions and expectations about what is possible and what is not. In fact, we have often looked to the development of new technologies to resolve thorny societal problems that have no obvious or tractable solutions. However, past efforts to correctly anticipate the use and impact of new technologies all too often have fallen short of the mark.

In the realm of communication alone, for example, the potential of the telephone was not widely appreciated, although Alexander Graham Bell, himself, had an uncanny prescience about its future use.<sup>1</sup> Nor did radio technology appear very promising—viewed primarily as a mode for point-to-point communication, microwave technology was rejected as being too difficult to focus and control.<sup>2</sup> More recently, the computer's role in society has far exceeded the expectations of its early creators and developers.<sup>3</sup>

The gap between expectations and actual experience with new technologies can be explained, in part, by our limited understanding of the relationship between technology and society. Attempts to depict this relationship have typically been unidimensional, focusing either on technology as a driving force or on a particular set of social forces that has determined the evolution of technology. However, experience has proven such conceptualizations to be far too simplistic. Lacking an adequate understanding of technological development we, as a society,

have been unaware of the realm of choices available. Thus, we have often been unable to channel technological development in the most positive directions.

Today, we are witnessing profound changes in communication systems worldwide brought about, in part, by the development and advancement of a wide variety of information and communication technologies. Together, these new technologies have significant potential to enhance communication and improve social, economic, and political circumstances in a number of different ways. If, as a society, we are to maximize this potential and have a greater choice about how these new technologies evolve, we will need to improve our analytical basis for assessing their development.

To this end, this chapter will provide an analytic framework for assessing the new communication and information technologies and the alternative roles that the Federal Government might play in their development and use. It will lay out a conceptual model of the relationship between technology and society that takes into account technological developments, social forces, and the values and roles of individuals and groups who have authority to make decisions about technology. The model will be used to define the scope of the OTA assessment and organize the report. By identifying the critical points at which choices about technology might be made, the model suggests the key questions that need to be raised about new communication technologies.

<sup>1</sup>From the beginning, Bell foresaw a network of private telephones that would be available to everyone, rich and poor alike. But most others—perhaps because it appeared so soon in the wake of the telegraph—found the telephone unworthy of comment. Totally underestimating the telephone's future, William Orton, President of Western Union Telegraph Co., for example, declined the opportunity to buy its patent rights, purportedly saying: "What use could this company make of an electrical toy?" Sidney H. Aronson, "Bell's Electrical Toy: What's the Use? The Sociology of Early Telephone Usage," Ithiel de Sola Pool (ed.), *The Social Impact of the Telephone* (Cambridge, MA: The MIT Press, 1977), p. 16.

<sup>2</sup>David Sarnoff, of NBC, took particular exception to this point of view. In a letter to Edward J. Nally, General Manager of the Marconi Co., he proposed taking advantage of the leaky aspects of this technology to develop a "radio music box." Gleason L. Archer, LL.D., *History of Radio to 1926* (New York, NY: The American Historical Society, Inc., 1938), p. 112.

<sup>3</sup>As Paul Ceruzzi has pointed out: "[Computer programmers] had no glimmering of how thoroughly the computer would permeate modern life. [They] saw a market restricted to a few scientific, military, or large-scale business applications. For them, a computer was akin to a wind tunnel; a vital and necessary piece of apparatus, but one whose expense and size limited it to a few installations." Paul Ceruzzi, "An Unforeseen Revolution: Computers and Expectations, 1935-1985," Joseph J. Corn (ed.), *Imagining Tomorrow: History, Technology, and the American Future* (Cambridge, MA: The MIT Press, 1986), p. 189.

## DEFINING KEY TERMS

To develop an analytic framework to examine the potential impacts of new technologies on communication systems, and to identify the potential ways that the Federal Government might respond to these advances, it is necessary to define the concepts, such as technology and communication, that are used throughout this report. Such terms are the building blocks of conceptual analysis. How they are defined will determine not only the scope of this study, but also the terms of the debate about, and the range of options for dealing with, new and emerging communication issues.

### *The Nature of Technology*

Technology can be defined in many ways, both broad and narrow. Some older definitions, for example, limit its meaning to specific tools or machines. Other theorists define technology more broadly as know-how—"a system of knowledge intended to have a practical bearing."<sup>4</sup> Beyond this, a definition of technology can also include the human processes and relationships required to bring a scientific idea to life.

People choose their definition of technology to suit the questions they are asking and the problems they must solve. Scientists and engineers, for example, may have less need to consider human factors; thus, their definitions concentrate on machines and physical structures such as roads, airports, and nuclear reactors.<sup>5</sup> However, a purely mechanical definition of technology would be inadequate for a study analyzing how technology might affect communication and communication systems. In this report, we have defined communication and communication systems as processes in which individuals and groups come together to

formulate, exchange, retrieve, and interpret information.<sup>7</sup> Understanding how technologies might affect these activities requires a definition of technology that is broad enough to include the intersection of physical objects and people. As Todd LaPorte has said: "One must look at 'who is technology' as well as 'what is technology'."<sup>8</sup>

This report, therefore, defines technology broadly, incorporating the relationships and transactions of those involved in communication processes. To maintain this view, while allowing for independent analysis of machines, tools, and techniques, the technology will be considered an interdependent (but not necessarily tightly connected) conglomeration<sup>9</sup> that, to borrow from Langdon Winner's categories, comprises:

- **apparatus:** the physical devices of technical performance, such as tools, instruments, machines, etc.;
- **technique:** the technical activities, such as skills, methods, procedures, and routines that people engage into accomplish tasks; and
- **social arrangements:** the relationships that are established and the transactions that place allowing people to carry out technical processes and to give physical form to their ideas.<sup>10</sup>

Looking specifically at apparatuses, for example, this report will consider how new technical applications might affect the formulation, exchange, and interpretation of information. Focusing on technique, the study will examine issues such as the kind of technical training and level of socioeconomic resources that would be required to successfully implement a new technical apparatus. And, in examining social arrangements, it will raise a number of institutional questions about who needs to cooperate with whom, and in accordance with what

---

<sup>4</sup>Jay Weinstein, *Sociology/Technology Foundations of Post-Academic Science* (New Brunswick, NJ: Transaction Books, 1982), p. xi. See also J.K. Fiebleman, "Pure Science, Applied Science, Technology Engineering: An Attempt at Definitions," *Technology and Culture*, Fall 1971, pp. 305-317; and Charles Susskind, *Understanding Technology* (Baltimore, MD: The Johns Hopkins University Press, 1973), p. 1.

<sup>5</sup>For a discussion of technology viewed as "a form of social organization," see Todd R LaPorte, "Technology as Social Organization," Institute of Governmental Studies, Working Paper, 4-384-1, University of California, Berkeley, n.d.

<sup>6</sup>Ibid.

<sup>7</sup>See following section for detailed definition of communication.

<sup>8</sup>LaPorte, *op. cit.*, footnote 5, p. 8.

<sup>9</sup>The notion of a loosely constructed conglomeration has been used here to convey the idea that technology is never a finished product, but is always evolving in relationship to social forces. In this sense, then, one might think of technology as a process. For a comparison of the characterization of technology in these two senses, see Jennifer Daryl Slack, "Historical Review of the Concept of Communication Needs With Respect to Technology," OTA contractor report, November 1987.

<sup>10</sup>Langdon Winner, *Autonomous Technology: Technics Out of Control as a Theme in Political Thought* (Cambridge, MA: MIT Press, 1977), pp. 11-13.

rules and regulations, if new technological apparatuses are to be effectively deployed. The impacts of new technology on communication and on society vary according to each of these aspects of technology, and they need to be considered both separately and in their entirety.

### ***The Definition of Communication and Other Related Terms***

**The** word “communicate” comes from the Latin root “**communis**,” signifying communion or the idea of a shared understanding of, or participation in, an idea or event. In this original sense, the word communication was used as a noun of action that meant “to make common to many (or the subject thus made common).”<sup>11</sup> Toward the end of the 17th century, the notion of imparting, conveying, or exchanging information and materials was incorporated into the concept.<sup>12</sup> Although modern dictionaries tend to adhere to the latter definition,<sup>13</sup> both connotations continue to survive in everyday speech. Their dual usage can, at times, be a source of confusion in discussions about communication. \*4

Academics and researchers have generally defined communication in accordance with the sender/receiver model developed by Shannon and Weaver in their work on information theory.<sup>15</sup> As depicted in figure 2-1, this model characterizes communication as a systemic process, the main components of which include: sender, message, transmission,

noise, channel, reception, and receiver. Although originally developed to account for technical aspects of information transfer, this model has had a much more general appeal and has been used to examine many forms of communication.<sup>16</sup>

Notwithstanding its past popularity and its record of versatility, the sender/receiver model is not particularly well-suited to many of the tasks required for this study, which seeks to address the entire range of policy issues raised by new communication technologies. Policy issues generally entail points of conflict, and this model is not designed to draw attention to them.<sup>17</sup> The rather passive notions of “message,” “sender,” and “receiver,” for example, draw attention to the problems of effective communication and downplay any problems involved in, or issues about, who gets to formulate, send, and access information, on what bases, and with what objectives and effects. Nor does this model provide a basis for raising questions and issues about communication goals. Effectiveness and efficiency are simply presumed to be the most appropriate measures for evaluating communication processes.

The sender/receiver model is also much too orderly to adequately describe many of today’s mediated communication processes. It assumes that communication takes place as a consistent, linear sequence of events—an assumption that is not supportable in today’s technology-mediated infor-

<sup>11</sup>Daniel J. Czitrom, *Media and the American Mind* (Chapel Hill, NC: The University of North Carolina Press, 1982), p. 10. It was clearly this definition that the philosopher, John Dewey, had in mind when he wrote in *Democracy and Education*: “Society not only continues to exist **by** transmission, **by** communication, but it may **fairly** be said to exist **in** transmission, **in** communication. There is more than a verbal tie between the words common, community, and communication. Men live in a community in virtue of the **things** they have in common; and communication is the way in which they come to possess things in common.” John Dewey, *Democracy and Education* (New York, NY: Macmillan Co., 1915), as cited in Czitrom, *supra*, p. 108.

<sup>12</sup>The use of the term **t** designate the physical means of communication evolved during the period of rapid development of railroads, **canals**, and **roads**. For a discussion, see Raymond Williams, *Keywords: A Vocabulary of Culture and Society* (New York, NY: Oxford University Press, 1976), pp. 62-63.

<sup>13</sup>*Webster’s New Collegiate Dictionary*, for example, defines communication as “an act or instance of transmitting,” and **as** “a process by **which** information is exchanged between individuals through a common system of symbols, signs, or behavior.”

<sup>14</sup>Czitrom, *op. cit.*, footnote 11, p. 10.

<sup>15</sup>Claude Shannon and Warren Weaver, *The Mathematical Theory of Communication* (Urbana, IL: University of Illinois Press, 1949), P. 5. The sender/receiver model has **recently** fallen on hard times as many communication researchers have become interested in elements of communication that are downplayed by the model, such as context, formal constraints of media, and cultural norms. For a discussion of other models of communication and a comparison of their strengths and weaknesses, see C. David Mortensen, *Communication The Study of Human Interaction* (New York, NY: McGraw Hill Book Co., 1974), ch. 2, pp. 29-65.

<sup>16</sup>Political scientists, for example, have employed this conceptualization to study propaganda and its effects. It has also been used in mass media studies to describe the one-way flow of information to mass audiences, and feedback in the form of buying **decisions** and comments to broadcasters. Sociologists have integrated it into their structural/functional models to examine the efficiency or effectiveness of organizational communication. The sender/receiver model has even been used in conjunction with humanistic models of interpersonal communication to explain problems in understanding as “breakdowns.”

<sup>17</sup>Joseph F. Coates, “What is a Public Policy Issue?” (Washington, DC, n.d.), P. 29. As **described**: “A public policy issue may be defined as a fundamental enduring conflict among or between objectives, goals, customs, plans, activities or stakeholders, which is not likely to be resolved completely in favor of any polar position in that conflict.”



Figure 2-1-Shannon/Weaver Model of Communication

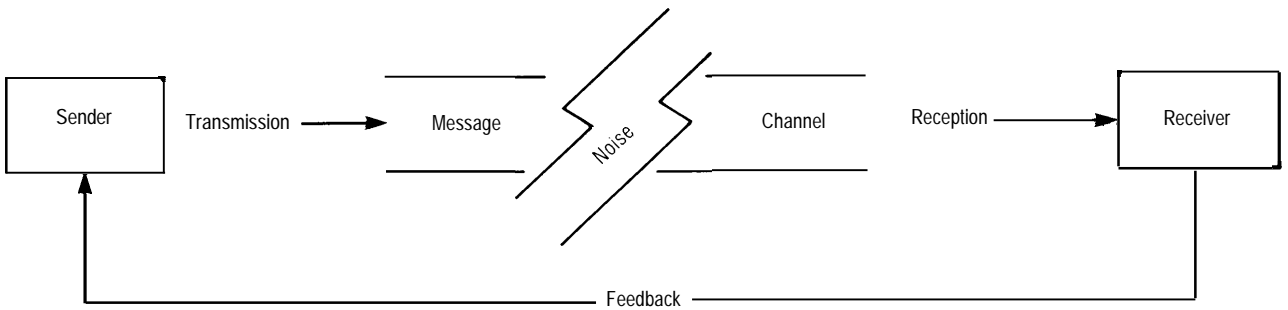

SOURCE: Office of Technology Assessment, based on Claude Shannon and Warren Weaver, *The Mathematical Theory of Communication* (Urbana, IL: University of Illinois Press, 1949), p. 5.

mation environment.<sup>18</sup> With a computerized bulletin board, for example, how does one identify and distinguish between who is the sender and who is the receiver? And, similarly, who is considered the sender when the receiver can now access information on demand?

To focus on potential areas of conflict, this study requires a model that highlights interrelationships and interdependencies among people and institutions. And, to bring the new technologies into play, it needs a multi-directional way of thinking about the process of communication. To meet these two requirements, **this study will define communication as the process by which messages are formulated, exchanged, and interpreted.** These activities are considered to be related to one another in a process, insofar as they are all required for an act of communication to take place. But the process is not necessarily linear, nor does it entail a predictable sequence of events. In fact, there are numerous ways in which these activities can be brought together, as can be seen in figure 2-2.<sup>19</sup>

Defining communication broadly in this fashion, it is clear that, just as it is becoming increasingly difficult to view communication technologies as being separate from information technologies, the process of communicating can no longer be viewed as a mere transmission process, separate from the

information that is being communicated. Thus, the analysis of new technologies will look at developments in information retrieval, processing, and storage, as well as information transmission and exchange. Similarly, the analysis of communication providers and the relationships among them will focus not only on the providers of communication channels and pathways, but also on the creators and users of information content.

Communication processes do not occur in a vacuum; rather, they are facilitated and sustained by an underlying network of individuals and institutions that provides the means and mechanisms for formulating, exchanging, and interpreting information, and for establishing the necessary linkages between these activities. In pre-industrial societies, such networks might entail a number of institutional structures such as kinship groups or caste systems; in advanced industrial societies, they are generally constructed around a complex set of technologies, assuming the broad definition of technology given above.<sup>20</sup> In this report, this entire network of apparatuses, knowledge resources, and institutional arrangements that support communications will be referred to as the **communication infrastructure**.

When such communication processes, technologies, and organizational and institutional relationships become established over time, they give rise to

<sup>18</sup>Nor does the linear model apply to interpersonal communications. It ignores the reciprocal aspects of communication and the fact that lists very much active participants. For the first interactive model that takes the reciprocal nature of communication into account, see Wilbur L. *The Process and Effects of Mass Communication* (Urbana, IL: University of Illinois Press, 1954).

<sup>19</sup>When the sequence of a communication process becomes established as a recognizable and predictable pattern of events, it takes on the aspect of what can be called a communication system. By "system" we mean, at the most basic level, a cyclical pattern of interlocking behavior based on expectations about what is taking place.

<sup>20</sup>This is not to say that social networks do not play a significant role in advanced industrial societies in facilitating the formulation, exchange, and interpretation of information. In trying to understand the impact of new communication technologies on society, one important research concern is the extent to which technologies replace these social networks, and with what effect.

Figure 2-2-Communication Process

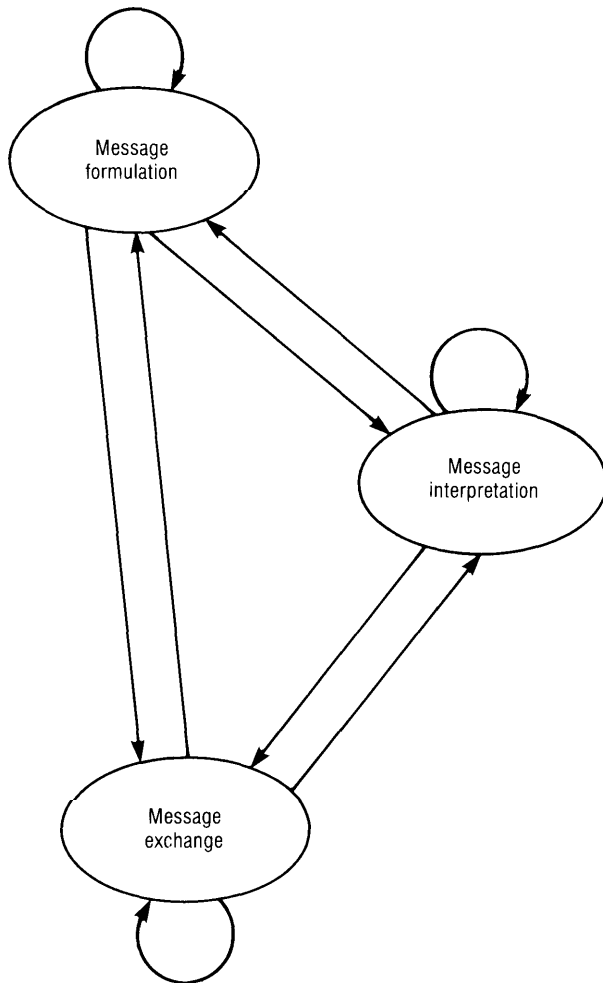

SOURCE: Office of Technology Assessment, 1990.

an accepted set of values, functions, behavioral norms and practices, and rules about how communication decisions should be made. Considered in their entirety, these institutional and organizational relationships, the infrastructure that sustains them, and

the norms that regulate and reinforce their behavior will be referred to as the **communication regime**.<sup>21</sup>

**The** communication regime is both nested in and sustains the larger social system of which it is apart, for communication is the basis for all human interaction and one of the means for establishing and organizing society. Communication is the process by which all social activity is conducted; without it, a society could not survive. It is the means by which group norms are established, expectations are voiced, individual roles are assigned, change is enacted, social control is maintained, and activities are coordinated.<sup>22</sup>

Communication also allows the individual to function in society. Only through interaction with others do individuals acquire the tools of language and the shared sense of reality they need to establish intimate relations and to cooperate to achieve common goals.<sup>23</sup> Through acts of communication, people define themselves—their sense of uniqueness as well as their self concepts—and negotiate and sustain a position and place in the world.<sup>24</sup>

Supporting all forms of human activity, communication runs like a thread entwined throughout the course of history. As Lucian W. Pye has described it:

Communications is the web of human society. The structure of a communication system with its more or less well-defined channels is in a sense the skeleton of the social body which envelops it. The content of communications is of course the very substance of human intercourse. The flow of communications determines the direction and the pace of dynamic social development. Hence it is possible to analyze all social processes in terms of the structure, content, and flow of communications.<sup>25</sup>

How the communication regime is ordered, therefore, is likely to have a significant impact on society, just as changes in society are likely to have a

<sup>21</sup>The term "regime" is borrowed from the field of international politics, where: "Regimes can be defined as sets of implicit or explicit principles, norms, rules and decision-making procedures around which actors' expectations converge in a given area of international relations. Principles are beliefs of fact, causation, and rectitude. Norms are standards of behavior defined in terms of rights and obligations. Rules are specific prescriptions or proscriptions for action. Decision-making procedures are prevailing practices for making and implementing collective choice." Stephen D. Krasner, (ed.), "Structural Causes and Regime Consequences: Regimes as Intervening Variables," *International Regimes* (Ithaca, NY: Cornell University Press, 1983), p. 2.

<sup>22</sup>Martin Lawrence LeFleur, *Theories of Communication* (New York, NY: David McKay CO. Inc., 1970). See also Lucian W. Pye (ed.), *Communications and Political Development* (Princeton, NJ: University Press, 1963), p. 4.

<sup>23</sup>Donald P. Cushman and Dudley D. Cahn, Jr., *Communication in Interpersonal Relationships* (Albany, NY: State University of New York Press, 1985). See also Donal Carbaugh, "Communication Systems: Exploring the Role of Information Technologies," OTA contractor report, December 1986.

<sup>24</sup>Ibid.

<sup>25</sup>Pye (ed.), *op. cit.*, footnote 22, p. 4.

considerable effect on the nature of the communication regime. Thus, in order to identify and understand the policy issues raised by new communication technologies, it is first necessary to construct a clearer picture of the relationships between technology, the communication infrastructure, and society.

## A CONCEPTUAL FRAMEWORK FOR ANALYZING POLICY ISSUES ENGENDERED BY NEW COMMUNICATION TECHNOLOGIES

Theoretical models are abstractions or simplifications of the real world as viewed from a particular vantage point. By defining critical relationships, such models serve as maps to guide researchers through extraneous materials to relevant questions and interesting insights. It will be useful, therefore, to begin the investigation of how new technologies might affect the realm of communication and society by conceptualizing how new technologies interact with society, and how choices about these technologies are made.

### Existing Conceptualizations

There is ample literature that seeks to explicate the causal relationships between technology and society.<sup>26</sup> Some thinkers on the subject posit that the role of technology is supreme, dictating social and economic relationships. In his work, *The Technological Society*,<sup>27</sup> Jacques Ellul, for example, argues

that the shape society takes is but a mere reflection of technique. In similar fashion, Harold Innis concludes, in *The Bias of Communication*,<sup>28</sup> that it is the modes of communication that determine the structure of society, a theme later developed by Marshall McLuhan in *The Medium is the Message*.<sup>29</sup>

The opposite proposition—that social systems structure technological developments—can be found in the tradition of Lewis Mumford. For example, in *Technics and Civilization*, Mumford contends that the invention of the clock was almost inevitable because the rigid schedule of monastic life required it.<sup>30</sup> More recently, this perspective resounds in the works of those who represent the “critical school” of communication.<sup>31</sup>

Acknowledging situations in support of both propositions, many scholars and researchers are now developing models about technology and society that are based on the interdependence and interaction of the two.<sup>32</sup> It is on this interactive model of technology and society, which is historically more realistic, that this and subsequent chapters will be based.<sup>33</sup>

### A Model to Guide the Present Analysis

The analytic framework that will be used in this assessment is depicted in figure 2-3. The key elements of this model are:

- the existing communication regime;
- the interactions between technological advances and social forces;

<sup>26</sup>The study of technology and society has a long history going back two centuries to the works of Adam Smith, Henri Saint-Simon, and Karl Marx. In fact, it was the growing interest in technological developments that gave rise to the field of sociology. Interest has intensified in recent years as both scholars and policymakers have sought to anticipate and ameliorate the unintended consequences of the deployment of technology. Once again, these interests have given rise to a new field of study, that of technology assessment. For three very different accounts of the history of ideas about technology, see Weinstein, op. cit., footnote 4; Winner, op. cit., footnote 10; and Jennifer Daryl Slack, *Communication Technologies and Society: Conceptions of Causality and the Politics of Technological Intervention* (Norwood, NJ: Ablex Publishing Corp., 1984).

<sup>27</sup>Jacques Ellul, *The Technological Society* (New York, NY: Knopf, 1964).

<sup>28</sup>Harold Innis, *The Bias of Communication*, 1951 (Toronto: University of Toronto Press, Reprint, 1971).

<sup>29</sup>Marshall McLuhan, *The Medium is the Message* (New York, NY: Random House, 1967).

<sup>30</sup>Lewis Mumford, *Technics and Civilization* (New York, NY: Harcourt Brace & Co., 1915).

<sup>31</sup>&., for example, Richard Collins et al. (eds.), *Media, Culture and Society, A Critical Reader* (London: SAGE Publications, 1986); see also, Michael Gurevitch et al. (eds.), *Culture, Society and the Media* (London: Methuen, 1982).

<sup>32</sup>See Slack, *Communications Technologies*, op. cit., footnote 26, p. 7, for a discussion of these approaches. It should be noted that these models differ with respect to the degree and timing of how society and technology influence one another. According to one school of thought, technology is essentially neutral before it has been developed. And it is only as technologies are exploited and molded in accordance with particular social, economic, and political conditions that it takes on a determining force of its own. For this view, see Clifford Christians, “Home Video Systems, A Revolution?” *Journal of Broadcasting*, vol. 17, Spring 1973, pp. 223-234. Others think of technologies as being biased in favor of particular outcomes at the moment of their conception because they are envisioned and designed with certain purposes and practices already in mind. For this perspective, see Raymond Williams, *Television Technology and Cultural Form* (New York, NY: Schocken Books, 1973).

<sup>33</sup>Two OTA workshops, “Characterizing the U.S. Communication System” (Jan. 9, 1987) and “Tracking Technology: A Workshop To Identify the Ingredients of Change” (Dec. 15, 1986), were important sources of information and insight for this conceptualization.

Figure 2-3-interactive Model of Communication and Society

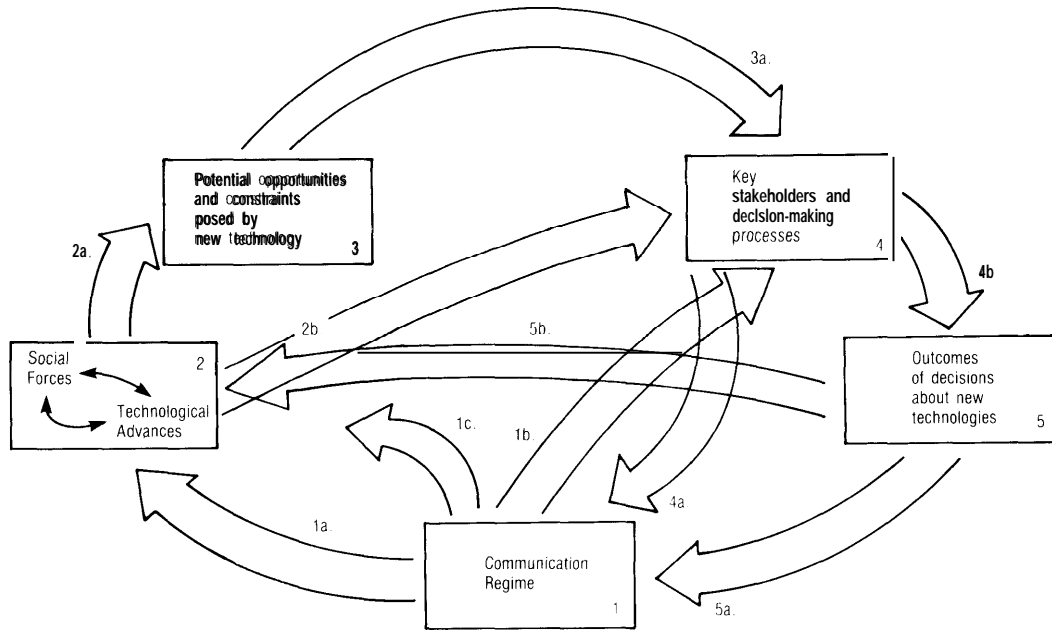

SOURCE: Office of Technology Assessment, 1990.

- Potential opportunities and constraints generated by new technologies;
- the key stakeholders and decisionmaking processes; and
- the outcomes of decisions about new technologies.

To follow this model, begin by focusing on the existing communication regime and trace the interactions and interrelationships between these elements (from 1 through 5 and back to the starting point). The arrows in figure 2-3 depict what are considered to be the most critical relationships.

### Existing Communication Regime

As defined above, the communication regime consists of the:

- a. norms, values, goals, and roles that sustain and maintain communication within a given realm;
- b. communication infrastructure that supports and facilitates communication processes; and

- c. decisionmaking processes and the rules and regulations that govern how the communication regime is managed and regulated.

As demonstrated in figure 2-3, the communication regime is not a closed system; it is influenced both by decisions that are made about the regime itself [4a] and by decisions that are made about new communication technologies [5a]. Moreover, the communication regime will also affect the larger society, of which it is a part. Because communication is essential to all social activities, how the communication regime operates will affect all social, economic, political, and cultural activities [1a], as well as the values and positions of key decisionmakers [1b]. Activities within the communication regime will also affect the level and direction of technological development [1c].

### Interaction of Social Forces and Technological Advances

Technological advances involving communication are the product of decisions made about

technological opportunities [5b] and the activities that take place within, and the outputs of, the communication regime [1c]. These technological advances are constrained in their effects on society, however. They are tempered by social forces (e.g., as economic and demographic trends) and major historical events (e.g., such as war or a depression) that may give rise to needs and conditions that can either foster or inhibit certain technological applications. The particular form or application of a new technology will also be shaped by the play of social forces and the conditions under which it is brought into use.<sup>34</sup> If the social and technological infrastructure is inadequate to exploit the benefits of new advances, some technologies may never be applied at all.<sup>35</sup>

Together, technological advances and social forces interact to create new ways of carrying out economic, political, cultural, and social activities, as well as new opportunities and constraints [2a]. The interaction of technological advances and social forces also creates new communication needs and desires, and changes stakeholder perceptions of their interests [2b].

### Potential Opportunities and Constraints Engendered by New Technologies

In figure 2-3, social forces and technological advances are viewed as converging to create new possibilities that, depending on how and by whom they are experienced, might be viewed as either potential opportunities or potential constraints. An opportunity in one realm of life, for example, maybe a constraint in another—just as something that benefits one person may create a problem for another.

Technological advances might give rise to new economic opportunities for some people, for example, by creating new markets for old products,

making possible new products, reducing production costs, or allowing newcomers to enter old markets. However, these same advances might establish new economic constraints for some producers if they increase the rate of obsolescence of some of their products, increase the number of their competitors, and/or reduce their market shares. Similarly, new political opportunities might be generated if technological applications reduce the costs for individuals and groups to participate in political processes, or increase their access to decisionmakers or to potential allies and supporters. But to those in the political process who may be circumvented by new technological applications, these developments will be perceived as a new constraint. The emergence of such opportunities provokes some stakeholders to reassess their needs, values, interests, resources, and traditional alliances, and to adjust. Other stakeholders may remain unaware of the significance of the changes, or be unable or unwilling to alter their behavior. Depending on their responses, the relative position and status of stakeholders are likely to change [3a].

### Key Stakeholders and Decisionmaking Processes

Whether or not new technological possibilities are developed, and how these opportunities and constraints are distributed among individuals and groups throughout society, will be determined by the decisions that are made about them in the context of existing institutional structures, laws, and practices [4a]. And such decisions will, in turn, depend on who the key decisionmakers are; how they perceive their needs and interests and goals and objectives in the light of new technologies; and the power and authority that they have to determine events.<sup>36</sup> Decisions about technology will be made consciously or inadvertently. They will be made in a

<sup>34</sup>For a description of how social forces have affected the design and development of communication technologies, see LeFleur, *op. cit.*, footnote 22. As he points out, these forces often override the idealistic aspirations and hopes that are attached to technological change. The development of the penny press is one example. Many social reformers hoped that it could be used to re-establish a broad moral and political consensus across the United States after the turmoil caused by the Civil War. Social and economic conditions worked against them, however. The penny press emerged not only in a period of cultural upheaval and transition, but also in a period of intense competition for advertisers and readers. Instead of trying to improve the cultural and moral standards of people, newspaper publishers felt compelled to adopt any sensationalist device so long as it would bring in additional readers. Czitrom, *op. cit.*, footnote 11, pp. 92-93.

<sup>35</sup>Such was the case in ancient Alexandria, for example. Although inventors had the theoretical knowledge necessary to create primitive versions of a steam engine and a wheeled cart, these ideas lay dormant and only became practicable in application centuries later in conjunction with the industrial revolution. Winner, *op. cit.*, footnote 10, pp. 73-74. More recently, this problem has become evident in a number of developing countries where government leaders have been disappointed by the failure of a high technology to take hold and catapult their nations into a new, modern era. W.W. Rostow, *The Stages of Economic Growth* (Cambridge, England: University Press, 1971).

<sup>36</sup>Decisionmakers have generally found such opportunities quite threatening. For an historical account of the conservative role that communication stakeholders played with respect to new technological developments, see Brian Winston, *Misunderstanding Media* (Cambridge, MA: Harvard University Press, 1986), pp. 15-34.

variety of arenas—the scientific/technical community; the marketplace; and the social/organizational, political, and cultural arenas. However, in any particular instance the outcomes of such decisions will be determined by, and reflect the preferences of, those who, within the relevant context, have the authority and/or the resources to structure the choices of others.

### **Outcomes of Decisions About New Technological Opportunities**

As decisions about new communication technologies are made, it will become clear which opportunities and constraints will materialize, and who will win and who will lose as a result.<sup>37</sup> These decisions, moreover, will affect all elements of the model, setting the entire complex of interrelated changes into motion once again.

Clearly, this framework is a simplification of the complex set of factors and interactions that come into play when new technologies confront society. However, by identifying critical relationships, it suggests the key questions to be examined and issues to be raised in identifying and analyzing future roles that the Federal Government might play with respect to new information and communication technologies. In this fashion, the framework provides the underlying rationale for the scope and structure of this report. As described below, the organization and the subjects of the chapters reflect the flow and logic of this model.

## **ORGANIZATION OF THE REPORT**

To assist Congress in determining appropriate communication goals for an age of information and advanced communication, this report is divided into three parts. Part I (incorporating boxes 1 and 2 in the model) examines the U.S. communication regime and how it is being altered in response to technological advances and changing social forces. It includes chapter 2; chapter 3, which discusses the norms,

policy goals, and rules that govern relationships in the communication infrastructure; and chapter 4, which examines how technological changes are affecting the interdependencies among producers, distributors, and users of communication facilities.

Part 11 (encompassing box 3 in the model) examines the potential opportunities and constraints posed by new technologies in four realms of life. Chapter 5 looks at how new communication technologies can be employed to create comparative advantage in the business arena, and the issues and policy implications to which these new possibilities give rise. Chapter 6 focuses on the role of new technologies in the political arena, and its impact on democratic processes. Chapter 7 examines what effect new technologies might have in allowing for broader participation in the shaping and development of culture, and what public policy steps might be required for such possibilities to be realized. And chapter 8 considers whether and how new communication technologies might be used to facilitate or detract from individual efforts to achieve personal autonomy and self-realization.

Part III (covering boxes 4 and 5 in the model) analyzes the crosscutting communication policy issues engendered by technological change, and identifies and evaluates alternative policy strategies and options for their resolution. Chapter 9 focuses on issues involving equitable access to communication opportunities. Chapter 10 looks at issues concerning the security and survivability of the communication infrastructure. Chapter 11 examines the problems and issues entailed in achieving interoperable communication systems. Chapter 12 considers the requirements and policy alternatives for modernizing the Nation's communication infrastructure. And chapter 13 analyzes the jurisdictional issues that are likely to arise in formulating and implementing a national communication policy.

---

<sup>37</sup>For a characterization of how these decisions are made in communication policy, see Vincent Mosco, *Pushbutton Fantasies* (Norwood, NJ: Ablex Publishing, 1982), figure 2-2, p. 26.

## **Chapter 3**

# **New Technologies and Changing Interdependencies in the Communication Infrastructure**

# CONTENTS

	<i>Page</i>
INTRODUCTION .. . . . . +. . . . . +. . . . .	41
THE COMMUNICATION INFRASTRUCTURE . . . . .	41
THE IMPACT OF TECHNOLOGY . . . . .	43
THE TECHNOLOGICAL EVOLUTION OF THE COMMUNICATION INFRASTRUCTURE . . . . .	44
The Technical Characteristics of the Communication Infrastructure . . . . .	44
Technological Trends Affecting the Communication Infrastructure. . . . .	45
STRUCTURAL CHANGES IN THE COMMUNICATION INFRASTRUCTURE . . . . .	67
Globalization of the Communication Infrastructure. . . . .	67
The Growing Importance of the Large User in Defining the Communication Infrastructure .. . . . +. . . . .	69
Vertical Integration of Key Industry Players and the Rise of the System Integrator . . .	70
Multiplication of Communication Networks . . . . .	71

## *Boxes*

<i>Box</i>	<i>Page</i>
3-A. The Intelligent Network . . . . .	47
3-B. Factors Affecting the Development of Residential Broadband Services . . . . .	49
3-C. Repeaters, Bridges, Routers, and Gateways . . . . .	64
3-D. Major Trends in the Local Area Network (LAN) Industry . . . . .	65

## *Figures*

<i>Figure</i>	<i>Page</i>
3-1. Diffusion of Technological Innovation . . . . .	44
3-2. Continued Deregulation and the Growth of Intelligent Carrier Networks Should Foster Rapid Growth in the ISDN Services Market Through the Next Decade. . . . .	51
3-3. The Number of Integrated Services Digital Network Trials Throughout the Country Doubled in Just a Year . . . . .	52
3-4. Intelligent-Network Equipment Markets: Annual Revenue by Equipment Type....	55
3-5. Consumer Videotex Subscriber Growth Leading Services: 1983 to 1990 . . . . .	56
3-6. How a Consumer's Credit File Can Travel . . . . .	66

## *Tables*

<i>Table</i>	<i>Page</i>
3-1. Types of Computers Used in Network Components . . . . .	46
3-2. Computer Costs, Capabilities, and Speed Over Time .. . . .	46
3-3. Fast-Packet Technology Promises More Options and Greater Flexibility . . . . .	48
3-4. Switching Technologies: Percentage of Total Access Lines .. . . .	54
3-5. Domestic Shipments of Telecommunications Equipment by Major Product Categories, 1975-2000, .. . . . 4 . . . . .	58
3-6. World Telecommunications Equipment Market . . +. . . . .	68



# New Technologies and Changing Interdependencies in the Communication Infrastructure

## INTRODUCTION

The communication infrastructure, which supports and negotiates the flow of communication within society, is a critical social structure. How it is constituted, and the rules that govern its use, will greatly affect the nature of all social interaction. The technical characteristics of the infrastructure, for example, limit the kinds of messages that can be exchanged, the ease and speed of exchange, and the fidelity of the messages. Similarly, the infrastructure's architecture-how facilities are arranged and distributed-will determine who will be able to communicate, under what conditions, and with what degree of effectiveness.

The form the communication infrastructure takes is determined by decisions made in the marketplace, as well as in the public, governmental arena. These decisions are greatly influenced by the economic relationships, or interdependencies, that exist among those involved in the formulation, exchange, and interpretation of information. And these interdependencies will depend, in turn, on the nature of the technological environment. Although at first glance the term "infrastructure" may suggest a permanent technological apparatus, the communication infrastructure, configured around economic interdependencies, is in fact very susceptible to technological change.

To establish optimal rules for governing the Nation's communication infrastructure in the future, Congress will need a more accurate picture of how technological advances are changing the communication infrastructure, its relationships, and its interdependencies. For, as Don R. Le Duc has pointed out in his analysis of broadcasting policies, all too often

Federal communication policies have failed for lack of consideration of private market incentives and imperatives.<sup>1</sup> To assist in understanding these variables, this chapter will:

- define the communication infrastructure and describe how it develops and evolves in relationship to changing technology;
- identify and describe the major technological changes likely to impinge on the present infrastructure;
- provide a brief overview of the U.S. communication infrastructure, and identify and describe the major changes that are now taking place within it; and
- identify and describe the potential implications of these changes for communication policy-makers.

## THE COMMUNICATION INFRASTRUCTURE

To analyze how technological advances might affect communication, it is useful to view the communication infrastructure from a systems perspective.<sup>2</sup> Such a perspective is particularly useful for analyzing change because it focuses on the interdependence of social structures rather than on their more static, or constant, attributes.<sup>3</sup> For, as defined by social psychologists Daniel Katz and Robert L. Kahn:

All social systems consist of the patterned activities of a number of individuals. Moreover, these patterned activities are complementary or interdependent with respect to some common output or outcome . . . .<sup>4</sup>

<sup>1</sup>Don R. Le Duc, *Beyond Broadcasting Pattern in Policy and Law* (New York, NY: Longman, 1987), P. 8.

<sup>2</sup>There is an enormous literature on the properties and behavior of social systems. See, for example, Daniel Katz and Robert L. Kahn, *The Social Psychology of Organizations* (New York, NY: John Wiley & Sons Inc., 2d ed., 1978); J.G. Miller, "Living Systems: Basic Concepts," *Behavioral Science*, vol. 10, 1965, pp. 193-237; and Talcott Parsons, *The Social System* (Glencoe, IL: Free Press, 1951). In using a systems approach, it is important to avoid the problem of reification-that is, speaking of systems as if they possess a personality. Systems are not "real," but rather are "interpreted" or "enacted" by their participants. See Eric Goffman, *Frame Analysis* (New York, NY: Harper and Row, 1974).

<sup>3</sup>Katz and Kahn, op. cit., footnote 2, p. 22.

<sup>4</sup>Ibid., p. 21. See also Karl E. Weick, *The Social Psychology of Organizing* (New York, NY: Random House, 1979).

Systems come into being as a result of, or in order to facilitate, exchange transactions.<sup>5</sup> Each transaction has a goal and some criteria for judging the success or failure of the interaction.<sup>6</sup> Over time, the relationships within social systems gain a degree of stability and consistency as certain kinds of behavior, attitudes, values, and criteria come to be associated with carrying out certain kinds of activities. Such expectations are generally socially reinforced and sanctioned.<sup>7</sup>

Although relatively stable, social systems are responsive to their environments and subject to change and dissolution. As Katz and Kahn point out:

As human inventions, social systems are imperfect. They can come apart at the seams overnight, but they can also outlast by centuries the biological organisms that originally created them. The cement that holds them together is essentially psychological rather than biological. Social systems are anchored in the attitudes, perceptions, beliefs, motivations, habits, and expectations of human beings.<sup>8</sup>

A system's continuity will depend on the extent to which it produces outcomes that fulfill the expectations of its participants, and on whether it generates the necessary incentives to sustain a given social activity. Insofar as these relationships are contrived—that is, people invent them by reenacting complex patterns of behavior—psychological factors, such as attitudes and expectations, will be critical to their existence.

In accordance with this analytic frame of reference, the communication infrastructure can be characterized as a social system. Building on the definition of communication established in chapter 2, the infrastructure is comprised of interdependent relationships among individuals and groups who cooperate to provide the means and mechanisms for formulating, exchanging, and interpreting information, and for establishing the necessary relationships among these activities. Together, this entire network of apparatuses, knowledge resources, and institutional arrangements, which supports all forms of communication, constitutes the communication infrastructure.

in the U.S. communication infrastructure, where so many communication functions are carried out in the private sector, economic criteria and economic interdependencies provide the primary context in which relationships are determined.<sup>9</sup> And the marketplace provides the major institutional mechanism<sup>10</sup> by which the signals and incentives that induce individuals and groups to interact with one another are transmitted and exchanged.<sup>11</sup> For example, market prices reflect costs of production, and consumer behavior will reflect market demand. Economic situations are generally based on the principle of rationality—that is, the certainty of the relationship between means and ends. It is assumed that people know what they want and how to transact to attain it. In an economic transaction, then, the

<sup>5</sup>For a discussion of exchange transactions, see L. B. Mohr, "The Concept of Organizational Goal," *The American Political Science Review*, vol. 67, 1973, pp. 470-481.

<sup>6</sup>However, these interdependencies are not necessarily established around equal relationships; nor do the parties involved need to share common goals. In order for these relationships to form, the people involved must believe that their ability to achieve their objectives will depend on what others do. For discussions, see Weich, op. cit., footnote 4, and J. D. Eveland, "Stakeholder Relationships in Communication Systems," OTA contractor report, October 1987.

<sup>7</sup>The expectations associated with the behavior of someone performing a particular task, or occupying a particular position, are called "roles." When individuals interact to accomplish a task, it can be said that they are in a reciprocal role relationship, and that their behaviors are governed by mutual role expectations. Because role relationships can be aggregated at any level, one can view society or any subunit within it, such as the communication infrastructure—as a complex network of systematically interlinked units of reciprocal role behaviors.

<sup>8</sup>Katz and Kahn, op. cit., footnote 2, p. 37.

<sup>9</sup>Exchange transactions and role behavior are not carried out in isolation, but within complicated sets of related goals, roles, rules, criteria, assumptions, and expectations about behavior and the outcomes sought, which are called "contexts." A context is embodied in language, descriptive vocabulary, and understanding of the implicit relationships between the parties involved in an interaction. It is the framework in which the construction and enactment of particular situations take place. Thus, for example, what distinguishes a family dispute from a manager-employee quarrel is less the absolute behavior, or even the words and body language, than the underlying assumptions about differences between family and organizational relations. People's assumptions about what outcomes they and others are seeking are central in short, the criteria being used by oneself and others. For analytic discussions of the notion of context, see L. Smircich, "Implications for Management Theory," L. Putnam and M. E. Pacanowsky, *Communication and Organization: An Interpretive Approach* (Beverly Hills, CA: Sage Publication, 1983), and P. McHugh, *Defining the Situation* (Indianapolis, IN: Bobbs Merrill, 1968).

<sup>10</sup>There are, of course, a variety of other political and social institutions that carry out parallel functions in other areas. For a discussion, see "Markets, Bureaucracies, and Clans," *Administrative Science Quarterly*, vol. 25, 1980, pp. 129-142.

<sup>11</sup>It should be noted that carrying out any role is heavily dependent on information. We need information, for example, to tell us what effect our behavior is having, what outcomes are being achieved, as well as what criteria are being satisfied,

emphasis is placed on the transaction rules of rationality, reciprocity, and competition.

By establishing the rules of behavior and the basic incentive structure in which economic players interact, national goals and public policies will also greatly affect the communication infrastructure. A discussion of communication policy and its impacts will be deferred, however, until the next chapter.

## THE IMPACT OF TECHNOLOGY

As is the case in all social systems, the set of relationships that constitutes the communication infrastructure is subject to changes in its environment. One external factor likely to have a major impact is technological change. Technological advances will clearly affect such things as economies of scale, the availability of product substitutes, and the costs of production. As Porter has described:

Technological change is one of the principal drivers of competition. It plays a major role in industry structural change, as well as in creating new industries. It is also a great equalizer, eroding the competitive advantage of even well-entrenched firms and propelling others to the forefront. Many of today's great firms grew out of technological changes that they were able to exploit. Of all the things that can change the rules of competition, technological change is among the most prominent.<sup>12</sup>

To a considerable degree, the impact of technological developments on the infrastructure will depend on the rate and speed of their diffusion. Although the diffusion of new technologies generally follows an S-shaped curve,<sup>13</sup> as depicted in figure 3-1, the rate at which a specific technology is adopted will depend on a number of factors, making

it difficult to assess the long-range impact of technological change.

Because the infrastructure as a whole is comprised of hundreds of technologies coexisting, each at different points on their diffusion curves, how quickly communication innovations will be adopted will be highly dependent on factors such as interconnectivity and the interdependence of content and equipment.<sup>14</sup> Although these technologies often appear to be competing, in many cases the growth in one medium will actually support growth in others. For example, the popularity of music videos on cable television reinforces the sales of audio recordings rather than substitutes for them.<sup>15</sup>

But network interdependence may also retard innovation. For example, once users have invested in equipment conforming to a particular standard, they will be reluctant to purchase any equipment that is incompatible. Users will invest gradually as old equipment wears out or is written off.<sup>16</sup>

As Everett Rogers has pointed out, the growth of a new product, although slow at first, will quicken with the development of a critical mass of users. This pattern occurs because the value of any communication system increases for all with each additional adopter.<sup>17</sup> Diffusion will also increase because new communication media are used as tools whose applications will multiply as they are adapted to new and different tasks.<sup>18</sup>

The deployment rate of new communication technologies will depend not only on the role that users play, but also on how communication and information providers react to technological advances. To channel technological change in their favor, communication-related businesses might

<sup>12</sup>Michael Porter, *Competitive Advantage: Creating and Sustaining Superior Performance* (New York, NY: The Free Press, 1985), p. 164.

<sup>13</sup>Analysts have mapped the life cycles of technological innovations on "diffusion curves" that plot the number of users adopting the Product over time. For discussions, see J.C. Fisher and R.H. Pry, "A Simple Substitution Model of Technological Change," *Technological Forecasting and Social Change*, vol. 3, 1971, pp. 75-88; Ralph Lenz, *Rates of Adoption/Substitution in Technological Change* (Austin, TX: Technology Futures, Inc., 1985); and David Rink and John Swan, "Product Life Cycle Research: A Literature Review," *Journal of Business Research*, vol. 7, 1979, pp. 219-242.

<sup>14</sup>Everett M. Rogers, *Communication Technology: The New Media in Society* (New York, NY: The Free Press, 1986), pp. 116-149.

<sup>15</sup>When two or more means of communication seem to fulfill the same function for potential users, they can both survive if each develops a particular niche in the marketplace. This is what happened, for example, with the introduction of television, which forced radio to become more of a local medium, financed through local advertising revenues. For a discussion of niche markets, see John Dimmick and Eric Rothenbuhler, "The Theory of the Niche: Quantifying Competition Among Media Industries," *Journal of Communication*, vol. 34, No. 1, Winter 1984, pp. 103-119.

<sup>16</sup>For example, growth in the sale of compact disc players is dependent on the availability of prerecorded compact discs. Thus, actions that affect the availability of discs will stifle growth in the sale of players as well. See John Quinn, "Help CDs Reach Their Market Potential," "Commentary," *Billboard*, Dec. 12, 1987, p. 9.

<sup>17</sup>See Rogers, op. cit., footnote 14, p. 120. See also Lynne Markus, "Toward a 'Critical Mass' Theory of Interactive Media," *Communication Research*, October 1987, pp. 491-511.

<sup>18</sup>Rogers, op. cit., footnote 14, p. 121"

Figure 3-1--Diffusion of Technological innovation

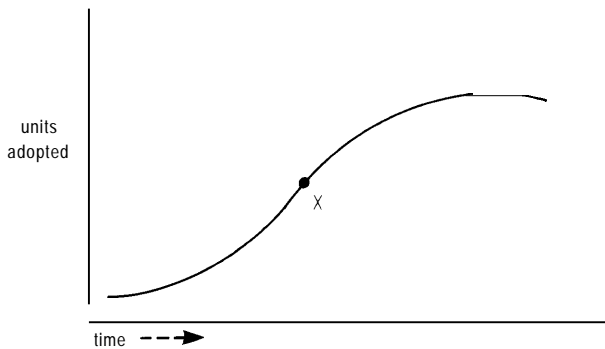

The classical diffusion curve is S-shaped, with the rate of change in the number of units adopted increasing until a "critical mass" point (x), at which the rate of growth reaches zero, then becomes negative. Growth continues to slow until the market is saturated. Penetration stays at this 'plateau' unless new consumers enter the potential-adopter pool (which causes new growth), or unless another innovation replaces the product (which causes a gradual decline).

SOURCE: Office of Technology Assessment, 1990.

seek, for example, to control patent developments, integrate markets, and/or employ the regulatory system to their advantage. Such strategies were adopted, for example, by Theodore Vail on behalf of AT&T in the years between 1879 and 1894.<sup>19</sup> According to Brian Winston, these defensive responses on the part of business give rise to what he has labeled "the law of the suppression of radical potential." This law, he says:

... operates firstly to preserve essential formations such as business entities and other institutions and secondly to slow the rate of diffusion so that the social fabric can absorb the new machine.<sup>20</sup>

To understand how technological changes might impinge on the communication infrastructure, it is necessary to examine the changing technological/economic context in which communication decisions are being made, as well as the potential ways in which key communication industry players might respond to such changes.

## THE TECHNOLOGICAL EVOLUTION OF THE COMMUNICATION INFRASTRUCTURE

### *The Technical Characteristics of the Communication Infrastructure*

The technical characteristics of the communication infrastructure establish the range of communication opportunities available and how they are allocated throughout society. More specifically, the technical functionality of the infrastructure will determine the following aspects of a communication system or facility:

- capacity (speed and volume of data transmission);
- flexibility (how easily the system can be modified);
- versatility (the extent to which the system supports a wide range of applications or services);
- interoperability (the degree to which facilities can transfer information or share resources automatically);
- timeliness (overall speed of message exchange);
- fidelity (the extent to which the technical quality of a message is compromised by transmission or playback);
- security (the ability to protect messages);
- survivability (the degree of resistance to natural or manmade crises, as well as the extent and speed at which a system can be restored);
- reach (the extent of a system's or facility's service area);
- openness (the ease with which the system and the service components that comprise it can be accessed);
- penetration (the density of the facilities within a served area); and
- usage (the levels of usage by those within a service area).

<sup>19</sup>For an account of these strategies, see Gerald Brock, *The Telecommunications Industry: The Dynamics of Market Structure* (Cambridge: Harvard University Press, 1981).

<sup>20</sup>Brian Winston, *Misunderstanding Media* (Cambridge, MA: Harvard University Press, 1986), pp. 24-25. This law, argues Winston, "explains the delay of the introduction of television into the United States which lasted at least seven years, excluding the years of war. It explains the period, from around 1880 to the eve of the First War, during which the exercise and control of the telephone (in both the United States and the United Kingdom) was worked out while its penetration was much reduced. It accounts for the delays holding up the long playing record for a generation and the videocassette recorder for more than a decade."

## Technological Trends Affecting the Communication Infrastructure

The technical characteristics and capabilities of the communication infrastructure will be significantly affected in the future, given a number of recent technological advances and developments.<sup>21</sup> These developments can be summarized in terms of the following trends.

### Greatly Improved Performance at Decreasing Costs

Performance has improved in all technical aspects of content production, encoding, transmission, decoding, and storage/retrieval. More than any other trend, this development will have an all-pervasive impact on the communication infrastructure. For many of these improvements result from advances in computer technology which, as can be seen in table 3-1, is ubiquitous throughout communication systems. The impact of these advances on the cost and performance of computer technologies can be seen in table 3-2.<sup>22</sup>

A critical factor in creating such performance/cost ratios has been the rapid advances in microelectronics resulting from the development of very large scale integration (VLSI).<sup>23</sup> VLSI allows the placement of over 10<sup>6</sup> logical operations on a single integrated circuit chip, and this number is doubling every 18 months. Given this level of integration,

communication within computers can take place much more rapidly and efficiently; bits no longer have to travel between chips over shared buses when the source and destination both reside on the same chip. Over the past 20 years, chip densities have increased several orders of magnitude.<sup>24</sup>

Improvements in materials and in the use of gallium arsenide (GaAs) in the production of chips will also permit greater integration. All silicon-based materials have a 0.2 micrometer limit to line width and therefore a limit to possible circuit density per chip. Because gallium arsenide has a smaller limit, it permits more logical operations per chip; chips designed using this material therefore offer greater speed. In the more distant future, the speed and size limitations of electronic devices will be overcome by using optical computing elements.<sup>25</sup> According to Ian M. Ross, President of AT&T Bell Laboratories, by the year 2000, it will be possible to place 1 billion components on a single silicon chip using these technologies.<sup>26</sup>

Advances in computer architectures and software have also helped to harness the processing power in communication applications.<sup>27</sup> In the past, switching mechanisms were used to replicate the manual operations entailed in placing a telephone call. The development of common channel signaling and intelligent databases now permits network switches to operate as computers, making real-time routing decisions based on the status of the network, call

<sup>21</sup>For additional discussion of advances see, for example, John S. Mayo, "Materials for Information and Communication," *Scientific American*, October 1986; Frank D. Reese, "Technology" Yesterday, Today and Tomorrow," *TE&M*, Jan. 15, 1988, p. 3; Bethesda Research Institute, "Study of Communications and Information Processing—Technologies, Structure, Trends, and Policy Considerations," OTA contractor report, 1986; U.S. Congress, Office of Technology Assessment, *Informing the Nation Federal Information Dissemination in an Electronic Age*, OTA-CIT-396 (Washington, DC: U.S. Government Printing Office, October 1988); Deborah Estrin, "Communication Systems for an Information Age: A Technical Perspective," OTA contractor report, December 1986; "Telecommunications: The World on the Line," *The Economist*, Nov. 23, 1985; "Hello Again: The Future of Telecommunications," *IEEE Spectrum* November 1985.

<sup>22</sup>Bartlett W. Mel et al., "Tablet: personal Computer in the Year 2000," *Communications of the ACM*, June 1988, pp. 639-646; and G. Pascal Zachary, "Awaiting the Next Generation of Personal Computers," *The Washington Post*, July 11, 1988.

<sup>23</sup>Estrin, op. cit., footnote 21, pp. 121-3.

<sup>24</sup>Ibid.

<sup>25</sup>Ibid. One of the problems with such densely integrated chips is the complexity of design. For this reason, much effort has shifted to developing VLSI design technologies to allow exploitation of current and future densities. This is one example of a syndrome evident in many areas of information technology. The underlying hardware developments have outstripped our ability to exploit the complexities that they introduce. At the same time, these hardware capabilities may be the key to solving some of the problems of complexity by relieving some constraints and by supporting increasingly complex design, development, and management tools.

<sup>26</sup>Such advances can be made, according to Ross, by taking advantage of ultraviolet and electron beam and x-ray lithography, increasing the size of chips, and moving to three-dimensional chip architectures. Ian M. Ross, Keynote Address for Publication in the Conference Proceedings of the 1988 Bicentennial Engineering Conference, Sydney, Australia, Feb. 23, 1988.

<sup>27</sup>VLSI is being used to support new computing architectures that provide for massive parallel processing (which allows computers to perform a number of operations simultaneously, rather than one by one). These architectures include dataflow, hypercube, and connection machine. VLSI also supports special-purpose architectures for specialized applications such as array processor image processing. These computing structures will eventually be found in the telecommunication system as switching components and as components of users' systems. Once again, the state of the art in operating systems and programming languages for these parallel architectures lags behind the system architecture itself, just as the system architecture lags behind the device technology.

**Table 3-1—Types of Computers Used in Network Components**

Network component	Types of computers used	Examples
Modem . . . . .	Integrated circuits	Hayes Smartmodem, Xyplex Nonwire, CASE Communications Series 4000, IBM 5866, Telindus Hyacinth
Multiplexer . . . . .	ICs, microprocessors	CCC ADCoMM 96/48, Aydin Monitor Systems T1 multiplexer
Matrix switch, PABX . .	Microcomputers, minicomputers	Bytex Autoswitch, M/A-Corn IDX750 Data PBX, T-Bar DSM Series 2001
PAD, network interface, protocol converter . .	ICs, microprocessors	ACC IF-370/DDN interface, BBN Communications C/10 PAD
Packet switch . . . . .	Micro-minicomputers	BBN Communications C/300 PSN, M/A-Corn CP9000 Series II
Gateway . . . . .	Micro-minicomputers, parallel processors	XMITxGATE 625, BBN Communications Multi-Corn X.25 Gateway
Network management & service systems . .	Micro-minicomputers, PCs, workstations	Northern Telecom DFMS, BBN Communications C/70 NOC, IDA-COM PT protocol tester

Key: **ICs** = Integrated **circuits**, LATA = local access and transport area, NOC = network operations center, **PABX** = private **automatic** branch exchange, PAD = packet assembler/disassembler, **PBX** = private branch exchange, PCs = personal computers, **PSN** . packet-switched network.

SOURCE: Reproduced by special permission of *Telecommunications magazine*.

**Table 3-2-Computer Costs, Capabilities, and Speed Over Time**

Decade	Computer costs, capabilities, and speed
1940 . . . .	In 1945, it cost about \$1,000 to do 1 million operations on a keyboard and took at least a month.
1950 . . . .	In 1952, it cost about \$300 to do 1 million operations and took 10 minutes.
1960 . . . .	In 1960, it cost \$75 to do 1 million operations and it took 1 second.
1970 . . . .	Computers can do 1 million operations for less than 6 cents in about 1/2 a second.
1980 . . . .	Computers can do 1 million operations for 1/10 of a cent in 1/10 of a second. Cost per 100,000 calculations decreased to \$0.0025 in 1980.
1990 . . . .	Between 1983 and 1997, computer costs to decrease by a factor of 100 with a 20 to 30% decrease in manufacturing costs.

SOURCE: Copyright 1989 by CMP Publications, inc., 600 Community Drive, Manhasset, NY 11030. Reprinted from *CommunicationsWeek* with permission.

loads, and the characteristics of callers.<sup>28</sup> As depicted in box 3-A, using Signaling System 7—the international standard for common channel signal-

ing—telephone company central offices can both exchange information on, as well as query databases about, the called or calling number.<sup>29</sup>

With new developments in switching technologies, these kinds of intelligent network operations can be executed with much greater flexibility and at increasing speeds .30 Fast packet-switching has been an important development in this regard.<sup>31</sup> This technology is similar to conventional (X.25) packet-switching in a number of ways. Like conventional packet-switching, fast packet-switching makes optimal use of a transmission channel. It breaks messages up into small bundles, or packets, each of which carries with it its own address; then interleaves them on a channel, taking advantage of the “silences” present in the information stream; and finally routes them throughout the network to their destinations where they are reassembled. Fast packet-switching offers the advantages of greater speed and flexibility. Whereas conventional packet-switching is suitable for data only, fast packet

<sup>28</sup>James E. Holcomb, “The Next-Generation Switch,” *Bell Communications Research Exchange*, September/October 1987, pp. 23-27; and Hildergard Pusch, “Aspects of CCS7 Network Configurations,” *Telecommunications*, October 1987, pp. 240-251.

<sup>29</sup>As discussed below, it is in fact this protocol that will provide the underpinnings of ISDN and the advanced intelligent network of the 1990s. See William Stallings, “Demystifying SS7 Architecture,” *Telecommunications*, March 1989, pp. 41-44, 46, 48. See also Paul Korzeniowski, “The Intelligent Transformation,” *CommunicationsWeek*, CLOSEUP, May 30, 1988..

<sup>30</sup>For a discussion, see Richard Vickers and Marek Wernik, “Evolution of Switch Architecture and Technology,” *Telecommunications*, May 1988, pp. 55, 58, 60, 62-64. As the authors note, this flexibility and speed is gained by separating the functions of call control from connection control, allowing for the establishing of virtual circuits, which provide logical rather than physical end-to-end connectivity. See also Denis Gilhooly, “Which Way for Broadband Switching?” *Telecommunications*, June 1987, pp. 36, 38-39, 42, 45; and A.M. Rutkowski, “Emerging Network Switching Technology and Applications,” *Telecommunications*, February 1987, pp. 40-41, 44, 46, 48, 50.

<sup>31</sup>Packet-switching was developed for data Communication between computers. Digital information is packaged into small pieces called packets, each containing information about the source and destination of the data and the relationship of that piece to the whole message. The packets are transmitted separately through the network, sometimes taking different paths depending on which ones are free at the moment. Packet-switching systems incorporate computers into the network in such a way as to make data transmission far more efficient. It is cheaper, faster, more accurate, and eliminates some incompatibilities.

### Box 3-A—The Intelligent Network

The intelligent network is comprised of four basic elements. These include:

- A Service control Point (SCP), which consists of a centralized database that uses algorithms and customer instructions to route messages;
- A Common Channel Signaling System (CCS7) that provides out-of-band, packet-switched communications among network elements;
- A Service switching point (SSP) that consists of local and tandem-switching nodes designed to carry out low-level, high-volume functions such as dial tone, announcements, and routing. The SSP performs functions as directed by the SCP; and
- An Operations Support System (OSS) that provides for network planning, engineering, provisioning, monitoring, maintenance, and repair.

How these elements relate to one another to provide service can be seen in the figure below.

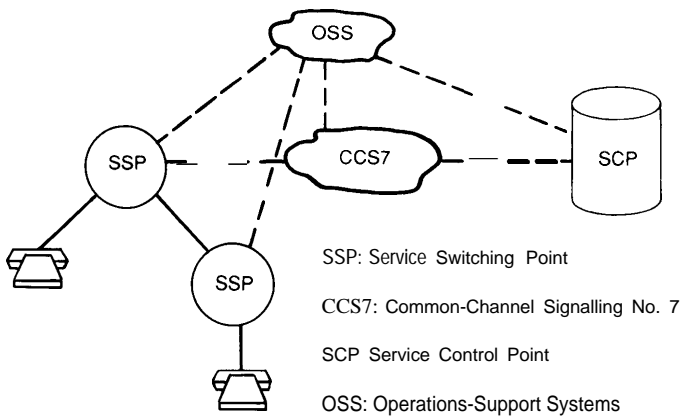

SOURCE: Art reproduced by special permission of *Telecommunications magazine*.

SOURCE: Paul Bloom and Patrick Miller, "Intelligent Network/2," *Telecommunications*, June 1987, p. 58.

To envision how this network operates, consider what happens with an 800 call. When an 800 number call is generated, it is sent to the SSP, which identifies it as an 800 call. At this point the SSP sends the number, together with other information about the calling party, to the SCP via the CCS7 signaling network and asks for further instructions about how to treat this call. The SCP searches its database, translates the received 800 number into a standard telephone number, and returns this telephone number together with a routing instruction to the SSP, which then routes the call to its correct destination.

technology can be used to switch voice, data, and video images in an integrated fashion (see table 3-3). Also, fast packet-switches can transmit hundreds of thousands or millions of packets per second, while conventional ones operate at a rate of only a few thousand packets per second.<sup>32</sup>

Even greater switching speeds can be anticipated in the late 1990s, when optical switching is expected to become a practical reality.<sup>33</sup> Optical switches will operate at much greater speeds than electronic switches because beams of photons pass through

each other without interfering, whereas electrons get in each other's way. Because high speeds permit massive parallelism and new kinds of architectures, photonic computers could have 1,000 times more power than today's electronic computers.<sup>34</sup>

Advancements in transmission technologies are keeping pace with, if not exceeding, those in switching. Developments in fiber optics, which provides an excellent medium for transmission, have been most significant. With minimal transmission loss, fiber allows many more signals to travel over

<sup>32</sup>David P. Helfrich, "Fast Packet Switching: An Overview," *Telecommunications*, November 1988, p. 68. See also James Brackett, "Fast Packet Switching: A Tutorial," *Telecommunications*, November 1988, pp. 65, 67-68, 70-72, and 76.

<sup>33</sup>Unlike optical transmission, optical switching is still a laboratory technology and is likely to be used only in specialized applications well through the end of the decade. Bell Laboratories in the United States and several commercial research laboratories in Japan currently lead the world state-of-the-art fiberoptic research and development. See J. Lenart, S. Su, and L. Jou, "A Review on Classification of Optical Switching Systems," *Telecommunications Magazine*, vol. 24, No. 5, May 1986. See also Michael Warr, "There Are No FINAL Frontiers," *Telephony*, Dec. 14, 1987.

<sup>34</sup>Eric E. Sumner, "Telecommunications Technology in the 1990s," *Telecommunications*, January 1989, p. 38. See also Lee Greenfeld, "Optical Computing," *Computerworld*, June 26, 1986, pp. 83-89.

**Table 3-3-Fast-Packet Technology Promises More Options and Greater Flexibility**

Network technology	Current maximum speed	Planned maximum speed	Plans for standardized multivendor interoperability	Functions supported
ISDN . . . . .	1.5 million bit/sec.	100 million bit/sec.	Yes	Voice, data, video, image
Traditional circuit-switched networks . . . . .	45 million bit/sec.	100 million bit/sec.	No	Voice, data, video, image
Packet-switched networks . . . . .	64 thousand bit/sec.	1.5 million bit/sec.	No	Data
Fast-packet . . . . .	1.5 million bit/sec.	100 million bit/sec.	Yes	Voice, data, video, image

SOURCE: Copyright 1989 by CW Publishing Inc., Framingham, MA 01701. Reprinted with permission from *Computerworld*.

longer distances with smaller numbers of repeaters than does copper wire.<sup>35</sup> In addition, the capabilities of lightwave transmission are doubling every year, a trend that is likely to continue for another decade. Already, commercial systems have been developed that transmit 1.7 billion bits of information per second on a single pair of glass fibers, an amount equivalent to 24,000 simultaneous phone calls.<sup>36</sup> In the future, the use of laser systems and wavelength division multiplexing on a single fiber will push transmission capabilities into the range of 20 gigabits per second.<sup>37</sup> With wave division multiplexing, each fiber optic cable can accommodate multiple channels by assigning each data stream a different wave length or color.

Given these advances, it is clear that any constraints on the deployment of fiber technology will be economic, not technological. Although fiber is increasingly being used for interoffice trunk lines, and even in some local loop facilities for business users, it is not expected to be extended to the home (with the exception of new construction) for a number of years.<sup>38</sup> For most of the residential community, fiber loop systems are still not economically viable; splicing and cabling costs are still high, and high-speed multiplexing is not as yet cost

effective. The demand for fiber in the local loop is still uncertain; most of the services in which residential users have shown an interest can be provided through the existing network, or, as in the case of video services, through alternative distribution channels such as cable TV and videocassette recorders.<sup>39</sup> Given its superior quality as a transmission medium, it is clear that fiber will eventually work its way into the home.<sup>40</sup> However, how and when this will happen will depend on a whole range of variables, a number of which are listed in box 3-B.

The major barrier to further improvements in the cost/performance ratios of information and communication technologies is in the area of software development. Software is pervasive throughout communication systems, and accounts for approximately one-half the cost of many systems. And programs are not only becoming larger in size; they are also much more complex. For example, a switching machine that in 1965 might have consisted of 100,000 lines of code would today require more than 2 million.<sup>41</sup> Thus, to fully exploit technological advances in other areas, software development will need to keep pace. Currently, however, software productivity is lagging behind hardware development.

<sup>35</sup>Commercially available fiber optic technology operates in the 500 million megabits-per-second range. However, fiber optics can carry data rates in the tens of billion gigabits-per-second range. Rates should increase in the future with the use of single mode fibers and coherent modulation/demodulation schemes. By 1990, two gigabit-per-second speeds should be commercially available. Estrin, op. cit., footnote 21, p. 17.

<sup>36</sup>Sumner, op. cit., footnote 34, p. 38.

<sup>37</sup>Estrin, op. cit., footnote 21, p. 16.

<sup>38</sup>For one discussion, see Robert M. Pepper, "Through the Looking Glass: Integrated Broadband Networks, Regulatory policies and Institutional Change," Working Paper No. 24, Federal Communications Commission, Office of Plans and Policy, 1988.

<sup>39</sup>For discussions, see Graham Finnie, "The Disciples of Fibre," *Telecommunications*, January 1989, p. 11; Les Hewitt and Mark Pitchford, "Making the Transition: Fiber Winds Its Way Home," *Telephony*, Feb. 15, 1988, pp. 35-39; Herb Brody, "The Rewiring of America," *High Technology Business*, February 1988, pp. 34-38; Bo Viklund, "Fiber Optics in the Local Loop," *Telecommunications*, May 1987, pp. 66, 68, 72; Graham Finnie, "Lighting Up the Local Loop," *Telecommunications*, January 1989, pp. 31-32, 37-38, 40; Lloyd F. Brisk, "Neighborhood Fiber: Putting a Laser in Everyone's POTS," *Telephony*, Feb. 20, 1989, pp. 27-28; and Tom Valovic, "The Rewiring of America: Scenarios for Local-Loop Distribution," *Telecommunications*, January 1988, pp. 30-31, 34, 36.

<sup>40</sup>Estimates are that within 2 to 4 years the cost of providing "plain old telephone w-vice" with fiber in the local loop will be less than the cost of providing POTS with copper wire. For a discussion, see Pepper, op. cit., footnote 38, p. 12.

<sup>41</sup>Sumner, op. cit., footnote 34, p. 38.



**Box 3-B—Factors Affecting the Development of Residential Broadband Services**

- the current level of penetration of analog coax-based CATV;
- PUC thinking as to the justification for BOC fiber-optic deployment;
- B-ISDN: technical advances in optical and fast-packet switching;
- demand for advanced information services in the residential setting;
- technical advances in video compression, HDTV, and other broadcast areas;
- convergence of the computer, publishing, and broadcast industries;
- ongoing deployment of fiber in the local loop by the BOCs;
- advances in LAN transmission over unshielded twisted-pair wire;
- investment incentives for BOC acceleration of CO switch upgrades;
- anticipated significant cost reductions in fiber-optic technology;
- the renewal of major cable franchises in the mid-1990 time frame,
- the threat of virtual remonopolization posed by a systems approach;
- the role of satellite transmission in television broadcasting; and
- current service demand levels as defined by POTS and entertainment video.

**KEY:** B-ISDN = broadband integrated services digital network, BOC = regional Bell operating company, CATV = community antenna television, CO = central office, HDTV = high definition television, LAN = local area network, POTS = plain old telephone service, PUC = public utility commission.

**SOURCE:** Reproduced by special permission of *Telecommunications* magazine.

### The Convergence of Communication Functions, Communication Media, and Communication Products and Services

Technological advances over the last decade have also led to the convergence of communication functions and communication media. For example, data processing and telecommunication were once clearly distinct sets of operations, carried out by quite different economic actors. This is no longer the case.<sup>42</sup> Digital switching and data processing now serve as the centerpieces of modern communication networks, and the networking of computers into local area networks, metropolitan networks, and wide-area networks is fast becoming the norm.<sup>43</sup> With the deployment of fast packet-switching and the integration of further intelligence into the telecommunication network, it will become increas-

ingly difficult to distinguish between the functions of switching and transmission.<sup>44</sup> To exploit the economic opportunities presented by this convergence, businesses that once were limited to providing telecommunication services are now joining forces with data-processing companies; and those that traditionally have focused on data processing are seeking to align themselves with those who have an expertise in transmission.<sup>45</sup>

One major technological advance contributing to this trend is digitalization—the process of transforming “analog” messages (a spoken word, a picture, a letter) into signals made up of discrete pulses that can be transmitted, processed, and stored electronically. When in a digital form, audio, video, and textual messages can be combined and recombined, allowing information to be integrated in a way

<sup>42</sup>See Stuart N. Brotman, “Integration in Key Communication Industries: Business and Policy Considerations,” OTA contractor report, June 1988.

<sup>43</sup>See discussion below.

<sup>44</sup>Gihong Kim, “The Evolution of Transmission Systems for the Next 10 Years,” *Telecommunications*, Aug. 10, 1987. Some examples noted by the author are statistical multiplexer, digital cross-connect systems, concentrators, and switches with built-in optical fiber interfaces such as DS3. See also A.M. Rutkowski, “Telecommunication Sandcastles: Boundaries That Have Outlived Their Usefulness,” *Telecommunications*, June 1987, p. 8; and Richard Solomon, “Broadband ISDN: With Computers, the Sums Are Always Greater Than the Parts,” *International Networks*, vol. 5, No. 2, Sept. 15, 1987.

<sup>45</sup>For examples, and a range of discussions, see John Foley, “Nynex Acquisition Strengthens Position as Systems Integrator,” *CommunicationsWeek*, June 20, 1989, p. 8; Carol Wilson, “The ‘New’ IBM Beckons to Telcos to Become Technology Partners,” *Telephony*, Mar. 21, 1988, p. 8; “DEC Scores Partners,” *CommunicationsWeek*, May 29, 1989, p. 1; Neil Watson, “HP Boosts T1MUX Packet Switch Offerings,” *CommunicationsWeek*, Apr. 10, 1989; Christine Bonafield, “AT&T Targets SNA Customers,” *CommunicationsWeek*, June 20, 1988, p. 1; Timothy Haight, “IBM Buys Into Fiber Company,” *CommunicationsWeek*, Jan. 16, 1989, p. 20; and Peter Purton, “Olivetti Expands Into Telephones,” *Telephony*, Mar. 6, 1989, p. 22.

that previously was impossible.<sup>46</sup> As Stewart Brand has described this phenomenon:

With digitalization all of the media become translatable into each other—computer bits migrate merrily—and they escape from their traditional means of transmission. A movie, phone call, letter, or magazine article may be sent digitally via phone line, coaxial cable, fiberoptic cable, microwave, satellite, the broadcast *air*, or a physical storage medium such as tape or disk, if that's not revolution enough, with digitalization the content becomes totally plastic—any message, sound, or image may be edited from anything into anything else.<sup>47</sup>

Digitalization was first introduced into the short-haul exchange of the telephone network in the early 1960s, and into the long-haul sectors and local exchange markets in the 1970s. With the development of digital loop technologies providing digital connectivity to the customer, it became possible to offer digital data services.<sup>48</sup> The development of, and growing demand for, these kinds of services further encouraged digitalization.<sup>49</sup> Transmitting digital data is much more efficient than transmitting analog data; in digital systems, data do not have to be converted into tones simulating a voice signal. Improvements in the performance and reliability of digital technologies, together with a reduction in their size and cost, have also fostered this trend.

Given these incentives to deploy digital technologies, it is likely that the interoffice telephone network will be almost totally digital by 1990, and that almost the entire local exchange will have acquired digital capability by the year 2000.<sup>50</sup>

The development of lightwave technology has also spurred the trend towards convergence. Given the generous bandwidths provided by fiber optics, telecommunication providers, for example, are no longer technically precluded from transmitting high-speed video images. According to one estimate, a broadband integrated services digital network (B-ISDN) could provide "four network-switchable channels with the capability of delivering current analog-type video services or future high-definition television on more than 100 megabits per channel."<sup>51</sup> Thus, with broadband networks, telephone companies will be candidates for providing video services at the leading edge.<sup>52</sup>

Epitomizing this trend toward convergence is the much touted B-ISDN.<sup>53</sup> Based on a common set of standards,<sup>54</sup> B-ISDN envisions a universal and ubiquitous system designed to provide efficient broadband interconnection for all possible communication services. Because it would not require separate systems for voice, data, and video, such a network would be truly integrated. To provide such

<sup>46</sup>The trend towards digitalization reflects the fact that digital technology is inherently more efficient than analog. In an analog network, data have to be converted into tones simulating a voice signal; in a digital system, the transmission of data does not require special processing. Digital technology has also been improved in terms of performance and reliability, while its cost and size have been significantly reduced. For a discussion, see Don R. Gibson and John M. Curry, "New Techniques for Digital Transmission," *Telecommunications*, January 1988, pp. 68-71.

<sup>47</sup>Stewart Brand, *The Media Lab: Inventing the Future at MIT* (New York, NY: Penguin Books, 1988), p. 19.

<sup>48</sup>Kim, op. cit., footnote 44.

<sup>49</sup>According to the Department of Commerce, data communication increased by almost 40 percent between 1970 and 1985. See *A Primer on Integrated Services Digital Network: Implications for Future Global Communications* (Washington, DC: NTIA, U.S. Department of Commerce, September 1983).

<sup>50</sup>Lawrence K. Vanston, Ralph C. Lenz, and Richard S. Wolff, "How Fast Is New Technology Coming?" *Telephony*, Sept. 18, 1989, pp. 47-52.

<sup>51</sup>M. Farooque Mesiya, "Implementation of a Broadband Integrated Service Hybrid Network," *IEEE Communication Magazine*, vol. 26, No. 1, January 1988.

<sup>52</sup>Whether or not they are free to do so from a regulatory perspective is, of course, a different question. As Robert Pepper notes: "There are significant regulatory and legal obstacles to telephone companies expanding those fiber networks into broadband networks if, realistically, the only broadband service they see as worth offering in the foreseeable future is video programming." Pepper, op. cit., footnote 38, p. 19.

<sup>53</sup>As defined by the Consultative Committee for International Telephone and Telegraph, Study Group XVIII, ISDN constitutes: "A network evolved from the telephone ISDN (Integrated Services Digital Network) that provides end-to-end connectivity support for a wide variety of services, to which users have access by a limited set of standards and multipurpose customer interfaces." In practice, ISDN has come to mean different things to different people and in different contexts. For some general discussions, see Tom Valovic, "Fourteen Things You Should Know About ISDN," *Telecommunications*, December 1987, pp. 37-38, 40, 42; Rolf Wigand, "Integrated Services Digital Networks: Concept, Policies, and Emerging Issues," *Journal of Communication*, vol. 38, No. 1, Winter 1988, pp. 29-69; and Lou Feldner, "Some Unresolved Questions on ISDN in a Competitive Environment," Harry M. Trebing and Patrick C. Mann (eds.), *Alternatives to Traditional Regulation: Options for Reform*, Proceedings of the Institute of Public Utilities, 19th Annual Conference, 1987, Michigan State University Public Utility Papers, East Lansing, MI.

<sup>54</sup>Standards for ISDN are being established by the Consultative Committee for International Telephone and Telegraph (CCITT). All of the standard ISDN interfaces are based on a multiple of a digital voice-grade channel (64 kilobits per second). These include the Basic Rate Interface, or 2B+D format, which provides a total channel capacity of 144 kilobits per second, and the Primary Rate Interface, or 23B+D format, which provides the equivalent to a T1 channel, that is, a total capacity of 1.544 megabits per second, and broadband ISDN, which provides dynamically configurable channels, or packets, at rates up to 150 megabits per second transmitted via an optical interface. Valovic, op. cit., footnote 53, p. 37.

capability, this network will take full advantage of both digitalization and lightwave technology.

The development of B-ISDN is still essentially in the planning stage, although recent standards developments have been quite promising.<sup>55</sup> Most ISDN activity has been limited to trials of narrowband ISDN applications, and most of these have been relatively modest. There are, for example, only about 70 large customers who are either involved in ISDN trials, or who are using commercially released ISDN products.<sup>56</sup> However, the rate at which trials are being undertaken has been increasing, and the market for ISDN is predicted to grow significantly over the course of the next decade (see figures 3-2 and 3-3).

A number of factors have accounted for the slow diffusion of ISDN into the telecommunication infrastructure. The fact that there is a large embedded investment in the existing network is probably the most important one. Private users, in particular, have already expended significant amounts of time and money developing their own sophisticated data communication systems, most of which would be incompatible with ISDN technologies.<sup>57</sup> Also, the purported benefits of ISDN, while appealing in theory, have yet to be demonstrated in practice.<sup>58</sup> Given such uncertainty, it may be difficult to convince users to purchase ISDN-related products and services at prices sufficiently high to cover the cost of their development and implementation.<sup>59</sup> This problem of pricing is compounded by the fact that there is no real historical basis for pricing what,

**Figure 3-2-Continued Deregulation and the Growth of Intelligent Carrier Networks Should Foster Rapid Growth in the ISDN Services Market Through the Next Decade**

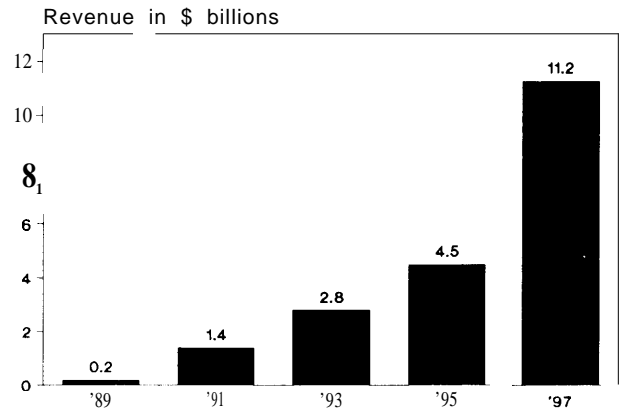

SOURCE: Copyright 1989 by CW Publishing Inc., Framingham, MA 01701. Reprinted with permission from *Computerworld*.

in reality, is an experimental service.<sup>60</sup> The long and cumbersome process of achieving standardization will also delay the deployment of ISDN. Without finalized standards, vendors have been very reluctant to develop ISDN-compatible products.<sup>61</sup>

The major push for ISDN will come from the public telephone companies. Because it will allow them to offer the kind of sophisticated services that business users will need in the future, such as virtual networks and customer control, the telephone companies view the development of ISDN as the critical component of their strategies to compete with alternative service providers.<sup>62</sup> Telephone compa-

<sup>55</sup>One of the most important recent events has been the international agreement reached on a standard for the Synchronous Optical Network (SONET) interface. For discussions, see Rodney J. Boem, "SONET: The Next Phase," *Telecommunications*, June 1989, pp. 37-38, 40; Gilbert L. Pringle, "Sonet: Problem or Opportunity," *Telephony*, Aug. 14, 1989, pp. 61-63, 65; and Thomas C. Miller, "Sonet and B-ISDN: A Marriage of Technology," *Telephony*, May 15, 1989, pp. 32-35, 38.

<sup>56</sup>Saroja Girshankari, "Gearing Up for ISDN's," *CommunicationsWeek*, CLOSEUP, Apr. 17, 1989, p. 37.

<sup>57</sup>Ultimately, the choice between a single public B-ISDN and separate, specialized, incompatible networks turns on the extent of long-run economies of scale and scope in telecommunications, and on the cost of gateways to connect incompatible systems." William Lehr and Roger G. Nell, "ISDN and the Small User: Regulatory Policy Issues," Center for Telecommunications and Information Studies, Columbia University, 1989, pp. 11, 19.

<sup>58</sup>For discussions, see Edwin E. Mier, "ISDN: Another version of the Emperor's New Clothes," *Data Communications*, December 1986, pp. 45-60; Sarah Underwood, "ISDN on Trial," *Damnation*, Feb. 1, 1987, pp. 51-56; and Candee Wilde, "ISDN: Let the Buyer Believe," *CommunicationsWeek*, Feb. 27, 1989, p. 44.

<sup>59</sup>See Kathleen Killete, "Controversial Costs," *CommunicationsWeek*, CLOSEUP, Sept. 18, 1988, p. C8; and Bruce Page, "Cost Is the Key," *Computerworld*, Dec. 12, 1988, p. 72.

<sup>60</sup>Ibid.

<sup>61</sup>Elizabeth Horwitt, "ISDN-Hungry Users Finding They're on a Restricted Diet," *Computerworld*, Feb. 27, 1989, p. 1.

<sup>62</sup>For one discussion, see Tom Valovic, "Will ISDN Replace Lam?" *Telecommunications*, September 1987, pp. 67-68, 70.

**Figure 3-3-The Number of Integrated Services Digital Network Trials Throughout the Country Doubled in Just a Year**

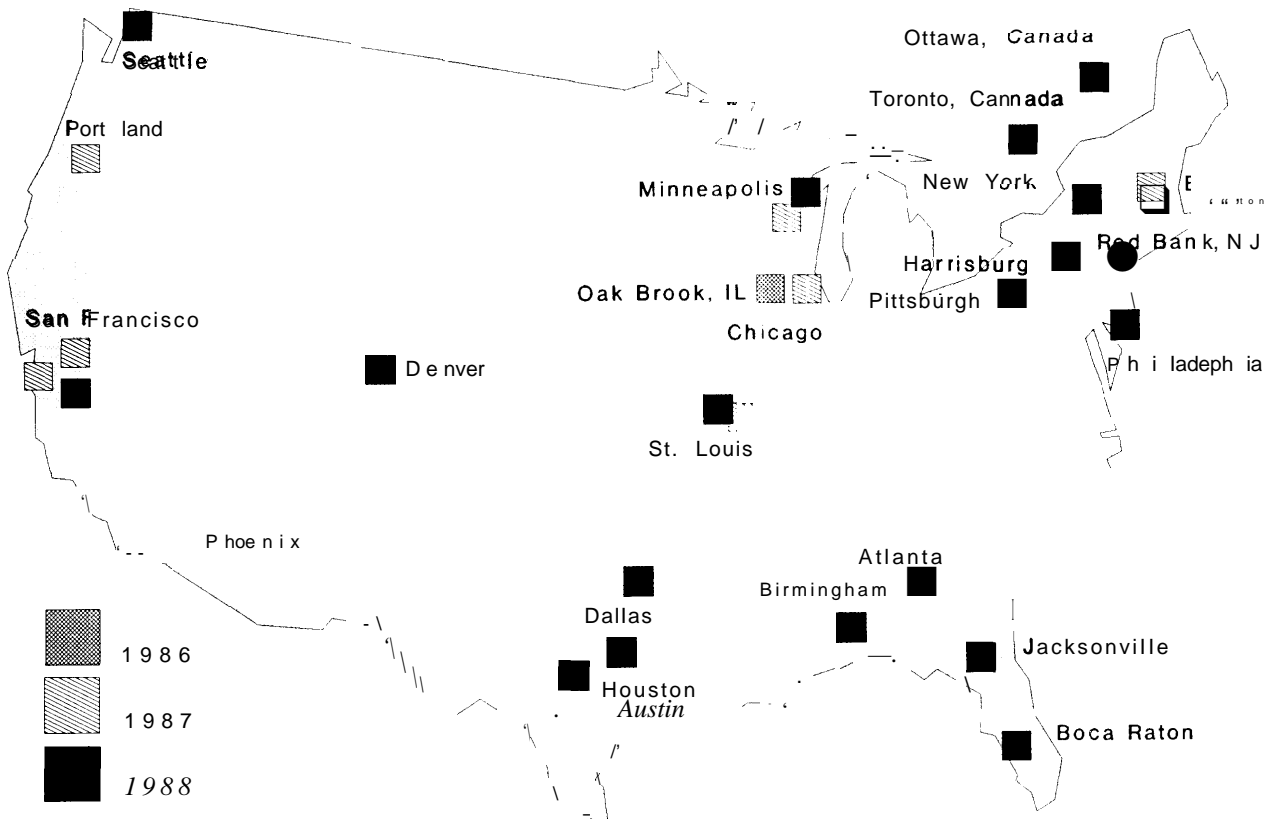

SOURCE: Copyright 1988 by CW Publishing Inc., Framingham, MA 01701 Reprinted with permission from *Computerworld*.

panies are already offering a number of Centrex services<sup>63</sup> that are designed to maintain, and even regain, their business customers and provide a transition to ISDN.<sup>64</sup> However, because the telephone companies have a large embedded investment in older equipment, they plan to move from narrow-band ISDN to broadband ISDN in an evolutionary, rather than a revolutionary, fashion. One major dilemma they face is that, by the time telephone companies can provide broadband services, other ways of meeting the needs of large business users may already be firmly entrenched.

The effects of digitalization will be experienced far beyond telecommunication. By providing the capability to integrate and process voice, video, and text, digitalization will also give rise to a wide range of multimedia applications, some designed to run on desktop computers.<sup>65</sup> Although this multimedia industry is currently only in its infancy, it is expected to constitute a \$7 billion market by 1994.<sup>66</sup>

One use of this technology will be to provide multimedia videotex, where the French have made a number of advances. This service is already

<sup>63</sup>Centrex services are the switched business telecommunication services that are provided from the telephone company's central office, rather than from equipment on the customer's premises. For discussions of the role of Centrex in the telephone company's competitive strategies, see John R. Abrahams, "Centrex Versus PBX: The Battle for Features and Functionality," *Telecommunications*, March 1989, pp. 27-28, 31-32; Carol Wilson, "Centrex II: The Telcos Revenge," *Telephony*, July 17, 1989, pp. 28-31; and James Quarforth, "Centrex to the Rescue," *Telephony*, July 17, 1989, pp. 22-23.

<sup>64</sup>See Martin Pyykkonen, "Centrex Now, ISDN Later," *Telecommunications*, February 1987, pp. 53-54, 84; and Martin H. Singer, "Hybrid Networks Move to Telecom's Center Stage," *Telephony*, Mar. 6, 1989, pp. 41-46, 51.

<sup>65</sup>Michael Alexander, "Everyone's Talking Multimedia," *Computerworld*, September 1989.

<sup>66</sup>Ibid.

available on the French Minitel 10 system where it is used, for example, to provide foreign language instruction.<sup>67</sup> The French are also using multimedia technology to provide compact disc selection via ISDN,<sup>68</sup> and they are now in the process of developing interactive digital video for use in the near future.<sup>69</sup>

Characterizing the momentum driving the trend toward multimedia technology, Stewart Brand points out:

Communication media are not just changing, they're changing into each other, and when they get together, they breed. Since the process self-accelerates and self-branches, there's no reason to expect a new stability any time soon.<sup>70</sup>

### **Decentralization of Intelligence Throughout Communication Systems With the Development of Software-Driven and Software-Defined Communication Facilities**

The greatly improved performance of computer technologies and their convergence with communication technologies have facilitated the dispersal of intelligence and control throughout communication systems.<sup>71</sup> More and more, systems are becoming defined and driven by software.<sup>72</sup> This development will make future communication technologies and systems more flexible and more versatile.

As noted above, it was digital processing that initially brought intelligence to the telecommunication network. The first computer-controlled switching systems were deployed 20 years ago. In the

1970s, when advances in integrated-circuit technology permitted the creation of a solid-state exchange, telecommunication providers began to deploy all-digital switches.<sup>73</sup> Today, approximately 98 percent of all AT&T switches are digital.<sup>74</sup> With respect to the regional Bell operating companies (BOCs), Nynex is 38 percent digital, Bell Atlantic 34 percent, Ameritech 30 percent, US West 30 percent, Pacific Bell 28 percent, and Southwestern Bell 25 percent.<sup>75</sup> For the projected deployment, see table 3-4.

With the development of even more powerful microprocessors, faster computing speeds, and larger memories, it is possible to locate intelligence not just in the central office switch, but also at nodes throughout the network. Because these "intelligent" nodes can communicate in real time with one another, as well as with other networks, communication systems based on this kind of architecture offer greatly enhanced flexibility—they can respond quickly to network problems and to changes in user demand; optimize network capacity; and ensure greater system and service reliability.<sup>76</sup>

This dispersal of intelligence throughout communication systems is well illustrated in the intelligent network. Using intelligent switches and databases, together with common channel signaling, the intelligent network allows network control functions to be separated from network switching functions.<sup>77</sup> This capability permits the network to select the most appropriate services and optimal routes, and to introduce new value-added services via simplified and modularized software. Among the services that

<sup>67</sup>For a discussion, see Herve Layec and Pierre-Louis Mazoyer, "Implementing Multimedia Videotex," *Telecommunications*, May 1989, pp. 57-60.

<sup>68</sup>Jean-Pierre Temime, "Videotex Enters Another Dimension," *Telephony*, Sept. 25, 1989, pp. 59, 62, and 64.

@Ibid., p. 60.

<sup>70</sup>Brand, *op. cit.*, footnote 47, p. 19.

<sup>71</sup>For a powerful, and highly influential, discussion of this trend, see Peter Huber, *The Geodesic Network: 1987 Report on Competition in the Telephone Industry* (Washington, DC: U.S. Government Printing Office, January 1987).

<sup>72</sup>The distinction between hardware- and software-based technologies is somewhat artificial. Hardware technologies rely increasingly on software design tools, while software developments are shaped by hardware support and developments. Moreover, a function that today is implemented in hardware may tomorrow be implemented in software, and vice versa.

Software systems are built on top of hardware technologies. These technologies are highly application-dependent and therefore the technologies and techniques are very diverse; thus, they are difficult to categorize. Included are switching protocols, network configuration and management, distributed operating systems and databases, network services such as directories and security, and protocol conversion. For a discussion, see Estrin, *op. cit.*, footnote 21, p. 11.

<sup>73</sup>Allen Adams and John Wade, "Looking Ahead to the Next Generation," *Telephony*, May 23, 1988, p. 57.

<sup>74</sup>Ross, *op. cit.*, footnote 26, p. 12.

<sup>75</sup>Paul Travis, "Which Way DO We Go?" *Telephony*, July 3, 1989, p. 36.

<sup>76</sup>John O. Boese and Richard B. Robock, "Service Control point: The Brains Behind the Intelligent Network," *Bellcore Exchange*, November/December 1987, p. 13.

<sup>77</sup>For discussions, see David G. Fisher and William Bauer, "Multiplexing With Intelligence," *Telecommunications*, February 1988, pp. 73-74, 79; see also Marcel E. Looson, "The State of the Intelligent Network Art," *Telecommunications*, February 1988, pp. 47, 52, and 57.

**Table 3-4--Switching Technologies: Percentage of Total Access Lines**

Year	EM	Analog SPC	Digital SPC	Total SPC	Total
1980	58.88	41.09	0.03	41	100
1981	52.86	46.96	0.17	47	100
1982	48.27	51.39	0.35	52	100
1983	42.74	56.35	0.91	57	100
1984	36.20	58.47	3.34	62	100
1985	30.84	59.54	9.62	69	100
1986	23.36	59.98a	16.67	77	100
1987	16.76	58.12	25.11	63	100
1988	10.39	56.48	33.12	90	100
1989	6.55	53.73	39.73	100	100
1990	4.65	50.57	44.78	95	100
1991	2.10	44.35	53.55	98	100
1992	1.14	36.49	62.37	99	100
1993	0.61	27.57	71.82	99	100
1994		19.07	80.61	100	100
1995		12.19	87.77	100	100
1996		7.35	92.61	100	100
1997		4.26	95.70	100	100
1998		2.41	97.55	100	100
1999		1.35	98.61	100	100
2000		0.74	99.22	100	100

Key: EM = electromechanical, SPC = stored program control

● Peak percentage for analog SPC

SOURCE: Reprinted with permission from Telephony, July 3, 1989.

the intelligent network can provide are dynamic call routing, call forwarding, call queuing, credit card billing, reverse charging, control of calls based on data held in a central database, wide area Centrex, and virtual private networks.<sup>78</sup> A description of the basic components comprising the intelligent network, and a discussion of how they are joined together to provide intelligent services, was provided in box 3-A.

Because software databases and intelligent switches can be accessed and modified by customers as well as by telephone-service providers, the integration of intelligence into the network will allow users to exercise much greater control over the services they receive.<sup>79</sup> For example, employing software-based management technologies, similar to those used by public network operators, users can customize their own services to optimize their

communication strategies, respond dynamically to emergencies, and optimize the use of the network's resources.<sup>80</sup> Eventually, residential users will be able to take advantage of these intelligent capabilities, using them, for example, to block 976 calls.<sup>81</sup>

The idea of developing an intelligent network is not new. It was first conceived by AT&T before divestiture as a means of providing nationwide 800 database services and private virtual networks.<sup>82</sup> Since divestiture, both AT&T<sup>83</sup> and Bell Communications Research (Bellcore), with the cooperation of other vendors, have been conducting research and development in this area. Equipment vendors are also engaged in developing products for these networks. As can be seen from figure 3-4, this activity is likely to increase in the future.

A number of factors should encourage this development. Most importantly, intelligent networks are likely to serve the needs and interests of both providers and users of communication services alike. With intelligent networks, for example, communication providers will be able to offer large business users the kinds of services and control to which they have become accustomed in their own private networks, thus helping the public switched network providers to regain, or at least maintain, a healthy portion of this lucrative business.<sup>84</sup> With continued advances in operating support systems (OSS), communication providers will also be able to exert greater control over the costs of the development and deployment of new services in the network. With sufficient revenues from business subscribers, providers will also find it easier to modernize the network while continuing to provide basic services that everyone can afford.<sup>85</sup>

Despite these incentives, the development of the intelligent network has been much slower than was originally anticipated. Initially, Bellcore planned to develop the intelligent network in stages—Intelligent Network/1 (N/1), which was intended for completion in 1991, and Intelligent Network 2

<sup>78</sup>Denis Gilhooly, "Welcome to a Future Where Less is More," *CommunicationsWeek*, CLOSEUP, Sept. 4, 1989, p. C5.

<sup>79</sup>Bob Vinton, "Aptitude of the IN," *CommunicationsWeek*, CLOSEUP, May 22, 1989, p. 49.

<sup>80</sup>Ross, op. cit., footnote 26, p. 17.

<sup>81</sup>Vinton, op. cit., footnote 79.

<sup>82</sup>Ibid.

<sup>83</sup>At divestiture, AT&T retained the Bell System resources that had been devoted to developing the intelligent network.

<sup>84</sup>For discussions, see Art Beaty, Jr., "The Evolution to Intelligent Networks," *Telecommunications*, February 1989, pp. 29-30, 32, 34, and 36; and Denis Gilhooly, "Towards the Intelligent Network," *Telecommunications*, December 1987, pp. 43-44, 46, 48,

<sup>85</sup>Ibid.

**Figure 3-4-intelligent-Network Equipment Markets: Annual Revenue by Equipment Type (\$millions)**

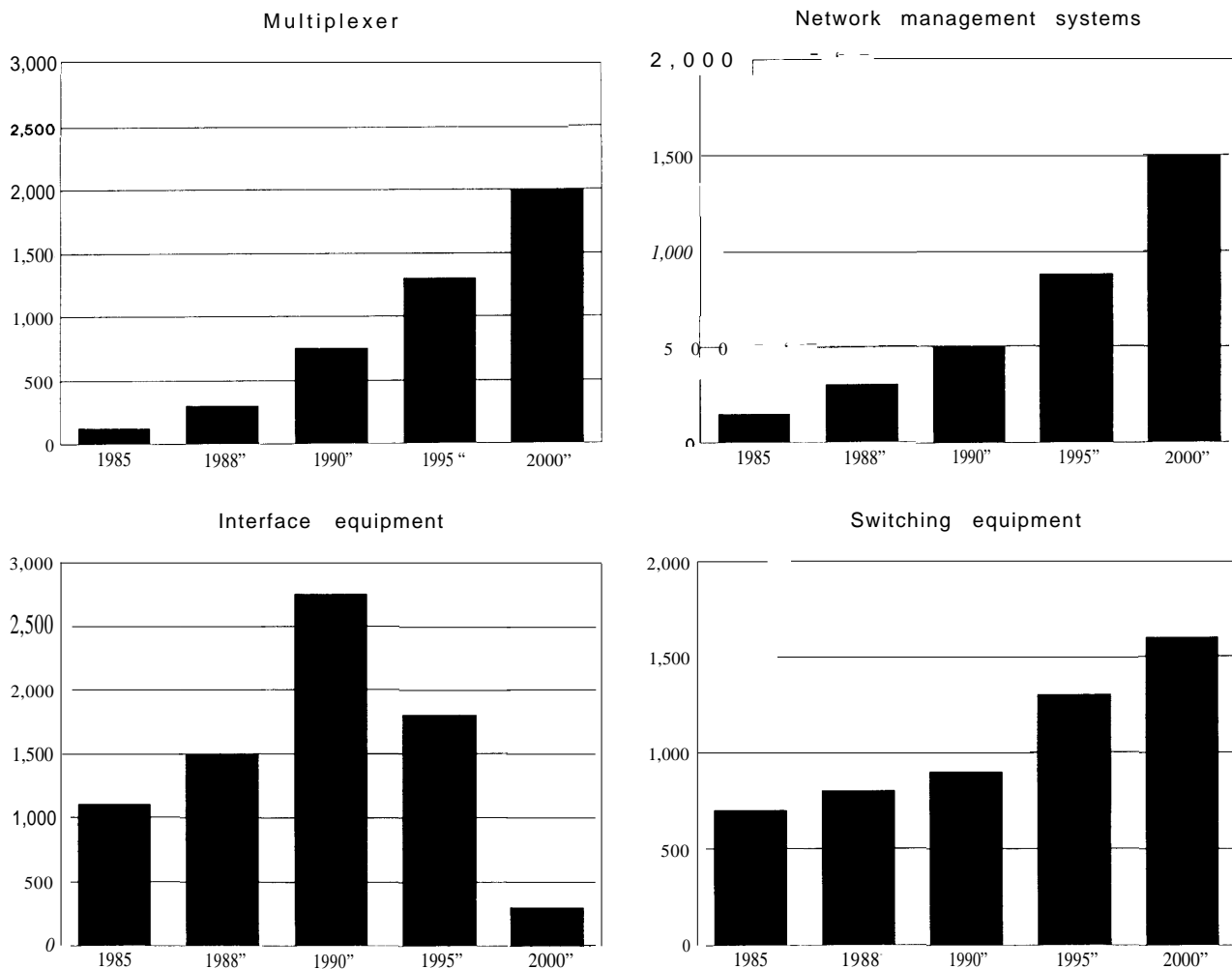

"Projected  
 SOURCE: Copyright 1989 by CMP Publications, Inc., 600 Community Drive, Manhasset, NY 11030. Reprinted from *CommunicationsWeek* with permission.

(N/2), which was cast as the network of the 1990s. Designed to be even more flexible than N/1, N/2 would allow services to be provided in a variety of physical network configurations under the control of many different entities.<sup>86</sup> In January 1989, however, Bellcore adopted a revised, more staggered approach, and postponed the development of the Advanced Intelligent Network (equivalent to an enhanced version of N/1, often referred to as N/1+) until 1995, a delay of 4 years. As explained by

Bellcore's division manager for network services product management:

I think the feeling was that we had better make sure that we understand what the performance implications of the architecture are well in advance of making a commitment to deploy.<sup>87</sup>

As part of this reassessment, Bellcore decided to coordinate its efforts more closely with telecommunication and data communication vendors. To this

<sup>86</sup>As described by Paul Bloom and Parck Miller, the concept of N/2 was "based on the premise that each customer service can be assembled from essential service capabilities. What distinguishes one service from another are the specific elemental capabilities used and the order in which they are sequenced." Paul Bloom and Patrick Miller, "Intelligent Network/2," *Telecommunications*, February 1987, pp. 57-60,64-65.

<sup>87</sup>Robert Preston, "Bells' Intelligent Network Could Be Delayed Until 1995," *CommunicationsWeek*, Feb. 20, 1989.

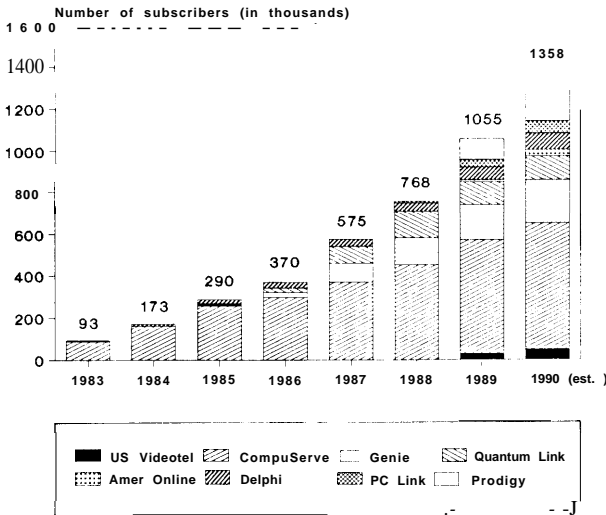
**Figure 3-5--Consumer Videotex Subscriber Growth Leading Services: 1983 to 1990**

SOURCE: Copyright 1989 by Jupiter Communications. Reprinted from *Conned Times* with permission.

end, it has set up the Multivendor Interactive Administrative Committee.<sup>88</sup>

The trend toward the dispersal of intelligence and control in communication systems is not limited to large telecommunication networks. Intelligence will also be provided to the user at office work stations or via computers, video terminals, or telephones in the home. For example, by 1993, according to one estimate, office work stations will be able to handle 32 million instructions per second; have 16 megabytes of random access memory, and cost approximately \$350.<sup>89</sup> Given such performance/price improvements, market analysts expect that, by early 1990, the total number of computer workstations in Europe, Japan, and the United States will surpass 100 million.<sup>90</sup>

Just as users of the intelligent network will have greater control over the types of services they

receive, so too will the users of intelligent customer-premises equipment. People can use interactive, intelligent terminals to do their own publishing, for example, by compiling, processing, and formatting information for themselves or others.<sup>91</sup> As Ithiel de Sola Pool described the situation:

The technologies used for self-expression, human intercourse, and recording of knowledge are in unprecedented flux. A panoply of electronic devices puts at everyone's hand capacities far beyond anything that the printing press could offer. Machines that think, that bring great libraries into anybody's study, that allow discourse among persons a half-world apart, are expanders of human culture. They allow people to do anything that could be done with communication tools of the past, and many more things too.<sup>92</sup>

Although the distribution of intelligence in this fashion can greatly extend the ways in which end-users can employ communication technologies, it can also discourage the adoption and use of technology if it requires users to have greater knowledge and skills. Many have suggested, for example, that videotex would be more popular in the United States if users could access it, as in France, on "dumb" terminals.<sup>93</sup> They note that audiotex services, which can be easily accessed over the telephone, have been much more popular than videotex. Despite the industry's difficult early years, its prospects for the future appear brighter, as evidenced in figure 3-5. The factors likely to account for this change include:<sup>94</sup>

- . the availability of better host/user software,
- . the availability of improved gateway services,
- . a greater number and variety of information services, and
- . an increase in the use of (and therefore comfort in using) personal terminals.

<sup>88</sup>Michael Warr, "Bellcore Slows Program for Network Evolution," *Telephony*, May 15, 1989, p. 12. It should be noted that some regional Bell operating companies are aiming to deploy the intelligent network ahead of the Bellcore schedule.

<sup>89</sup>Gilhooly, *op. cit.*, footnote 78, p. C4.

<sup>90</sup>*Ibid.*

<sup>91</sup>For a discussion of how new technologies allow individuals to more easily become creators and information providers in their own right, see "Impact of Technology on the Creative Environment," U.S. Congress, Office of Technology Assessment, *Intellectual Property Rights in an Age of Electronics and Information*, OTA-CIT-302 (Springfield, VA: National Technical Information Service, April 1986), ch. 5.

<sup>92</sup>Ithiel de Sola Pool, *Technologies of Freedom* (Cambridge, MA: The Belknap Press of Harvard University, 1986), p. 226.

<sup>93</sup>Sam Simon, President, Issue Dynamics, Inc., personal communication, September 1987.

<sup>94</sup>"Leading Videotex Services Top a Million: Revenues Follow 80/20 Rule," *Connect Times*, April/May 1989, p. 6.



## Unbundling of Some Communication Services or Functions

Unbundling refers to the ability to separately purchase communication services or functions that were formerly available only as a single unit. Linked to the trends of convergence and decentralized intelligence, this phenomenon is becoming increasingly prevalent in all communication systems. While unbundling allows for greater access to, and control over, communication services, it can also create problems for the interoperability, security, and survivability of the communication infrastructure.

Unbundling first appeared in telecommunication with the Carterfone decision of 1968,<sup>95</sup> which allowed customers to add equipment to their telephones as long as they did not adversely affect the operation of the telephone system or its usefulness to others.<sup>96</sup> A clarification of this decision by the FCC in December 1988 extended its provisions to microwave systems and computers. The Carterfone decision ruptured the well-established arrangement whereby AT&T was assigned the responsibility of providing national end-to-end telephone service. Applied broadly, these decisions encouraged the entry of new entrepreneurs who wanted to plug into the network with new kinds of customer-premise equipment (CPE) or enhance the value of their private systems by interconnecting with the public network.<sup>97</sup> Thus, they cleared the way for the development of entirely new communication industries.

Many other factors and events also contributed to this development. As Stone has pointed out, given the numerous technological advances that had been made in communication and computers, together

with the greatly increased post-war demand for service, it is likely that:

... no one firm—not even one as large as AT&T—could possibly seize all of these opportunities as rapidly as they could be realized.<sup>98</sup>

The growing convergence of computer and communication technologies made it even more difficult to determine what “end-to-end” service should entail.<sup>99</sup> Capping off all of these developments was divestiture and the breakup of the Bell System.

Today, the unbundling of the communication infrastructure is clearly demonstrated by the emergence of a whole range of communication equipment providers. AT&T’s share of this market has dropped precipitously; for example, with respect to equipment sold to telephone companies, its market share has fallen to between 40 and 60 percent.<sup>100</sup> As can be seen in table 3-5, CPE vendors constituted a \$25.6 billion market in 1988. In recent years, however, profit margins have been eroding due to extremely competitive conditions and the failure of most vendors to offer overall system solutions.<sup>101</sup>

Unbundling is also apparent in the extent to which users now own their own dedicated units. As Peter Huber has pointed out:

Twenty years ago CPE markets were comparatively tiny. Equipment that was located on customer premises—everything from handsets to mainframe computers—was provided only under lease, and then only grudgingly, with strict instructions that nothing was to be tampered with in any way. The real electronic brains stayed safely in the central-office, where the no-tampering policy could be enforced even more fully.<sup>102</sup>

Now major companies such as AT&T and IBM are in the business of selling equipment, not renting it.

<sup>95</sup>“AT&T—Foreign Attachments, Tariff Revisions,” 15 FCC 2d 605 (1968).

<sup>96</sup>The Carterfone was a device that permitted callers to use the telephone network to communicate directly with others located at remote mobile radio terminals. It was not the first telephone attachment to be developed outside of the Bell System. As Alan Stone has pointed out, there have always been inventors developing attachments that could supplement or even substitute for Bell equipment. However, both AT&T and State regulatory authorities strongly opposed the use of such components, viewing them as inimical to the well-established requirement that AT&T provide end-to-end service. For a discussion, see Alan Stone, *Wrong Number The Breakup of AT&T* (New York, NY Basic Books, Inc., 1989), pp. 87-90.

<sup>97</sup>*Ibid.*, p. 95.

<sup>98</sup>*Ibid.*

<sup>99</sup>To sort out this issue, the FCC undertook a series of computer inquiries, (called Computer Inquiry I, II, and III), none of which fully resolved this problem. For a discussion, see Anthony Rutkowski, testimony at hearings before the House Subcommittee on Telecommunications and Finance, July 30, 1987.

<sup>100</sup>Roger Noll, “Telecommunications Regulation in the 1990s,” Stanford University, Center for Economic Policy Research, Publication No.140, August 1988, p. 19.

<sup>101</sup>Susan Ubis and Czardana Inan, “Feeding Frenzy Grips Competitive CPE Market,” *Telephony*, Apr. 11, 1988, pp. 32-35.

<sup>102</sup>Huber, *op. cit.*, footnote 71 • P. 11 •

**Table 3-5-Domestic Shipments of Telecommunications Equipment by Major Product Categories, 1975-2000 (in current \$million)**

Year	Switching equipment	Transmission equipment	Customer premises equipment	Cable/wire and lightguide	Total
1987 .....	4,075	6,525	11,240	2,230	24,070
1988 .....	4,400	6,950	11,950	2,350	25,650
1989P .....	4,660	7,213	12,667	2,435	26,975
CGR 79-89 .....	1.570	8.6%	5.40/0	-1 .20/0	4.4%
CGR 89-00 .....	5.2%	5.5%	5.3%	3.00/0	5.1%

Key: CGR = average annual compound growth rate, p. projection.

SOURCE: U.S. International Trade Commission and Computer and Business Equipment Manufacturers' Association (CBEMA) Industry Marketing Statistics.

At the same time, many large users are growing accustomed to owning and operating their own communication networks. According to Huber, in 1987, private buyers accounted for 80 percent of the purchase of satellite transmission service, 40 percent of the telephone switching market, 20 percent of microwave transmission equipment, and 20 percent of fiber-optic cable and electronics.<sup>103</sup> In addition, sales of mainframes have greatly declined in favor of purchases of mini- and micro-computers.<sup>104</sup>

The development of open network architecture (ONA) will lead to the further unbundling of the telecommunication network. But, as previously noted, the ability to open the network will depend, in part, on both software development and the advance of the intelligent network.<sup>105</sup> If pursued far enough, open architecture would allow independent providers and other users to purchase the most elemental network functions. They could also create their own products, reconfiguring and customizing these functions to meet their own needs.<sup>106</sup>

However, technology will not be the only determinant of network architecture. Because open architecture will affect the security and interoperability of the infrastructure, as well as the efficiencies and costs of providing services, the issue of how open the communication infrastructure should be is a matter of considerable debate.<sup>107</sup> Also, not all users will want to buy unbundled services. As a number of business users are finding out, although unbundling can reduce prices and increase their purchasing

choices, it also transfers to them the burden of network planning and management. Many businesses are finding it difficult to take on this new responsibility. For some, the only option is to pay a systems integrator to rebundle the products and services they need.<sup>108</sup>

Many of the advantages and disadvantages of unbundling telecommunication products and services, and hence the factors that are likely to drive this trend, can be seen by examining the private branch exchange (PBX). A private switching system located on a customer's premises, the PBX is, in effect, a small local telephone office. Because it competes directly with the providers of public switched services, the PBX provides an excellent paradigm for considering developments in this area. As Peter Huber explains:

PBXs are complex and expensive, they require sophisticated forms of interconnection with the public network, and they compete directly with network-based services such as Centrex. PBX-based private networks are the main competitive threat to the local exchange monopoly.<sup>109</sup>

The fortunes of the PBX industry mirror those of many other manufacturers of customer premises equipment. The PBX was first developed and used within the Bell System and leased by telephone companies to business users. In the wake of divestiture, a number of companies, including AT&T and the BOCs, began to manufacture and distribute PBX

<sup>103</sup>Ibid.

<sup>104</sup>Ibid.

<sup>105</sup>Ibid.

<sup>106</sup>A.M. Rutkowski, "The Second National Open Network Architecture Forum," *Telecommunications*, May 1987, pp. 118-119, 123.

<sup>107</sup>The policy issues entailed in this decision are discussed in chs. 10 and 11.

<sup>108</sup>A discussion of the emergence of the systems integrator as a strategic player in the communication infrastructure appears later in this chapter.

<sup>109</sup>Huber, op. cit., footnote 71, p. 16.1.

equipment for sale.<sup>110</sup> This market flourished in the aftermath of the Carterfone decision and divestiture.<sup>111</sup> New players abounded. Incorporating the latest digital computer technology into the PBX, the largest manufacturers such as Northern Telecom and Rolm were able to make considerable inroads into AT&T's share of the market.<sup>112</sup> With users eager to take advantage of the liberalized, post-divestiture environment, demand soared; between 1982 and 1985, total system shipments increased by about 20 percent.<sup>113</sup>

The tide turned, however, in 1986, when the demand for PBXs began to flatten out, a trend that is projected to continue in the near future.<sup>114</sup> Two factors have contributed to this reversal, both of which suggest that users are only now beginning to come to grips with some of the more problematic aspects of unbundling. The first of these is the reemergence and upgrading of Centrex services. Over the last several years, telephone company providers have sought to regain lost customers by aggressively marketing their Centrex offerings, providing services that compete directly with PBXs, such as central office local area networks (CO-LANs). And they have been quite successful. Many users, disillusioned by the hidden costs and problems entailed in running their own communication networks, are looking to public network providers to develop new kinds of solutions for them, such as hybrid and virtual private networks.<sup>115</sup> Thus we see that, while the PBX market has remained flat, Centrex has grown during the last 3 years at an annual rate of more than 20 percent.

The second factor contributing to the PBX industry's change in fate is the evolution of network technologies and the development of system standards such as integrated services digital network

(ISDN) and open systems interconnection (OSI). While PBX manufacturers have tried to upgrade their systems technologically,<sup>116</sup> they have been slower at adapting their products to international standards. However, as more and more products and services are unbundled, it will become even more important to users that they be interoperable. And with recent progress towards developing international standards, many users are becoming less inclined to purchase PBXs without some assurance that they will be able to fit in.

Generalizing from the case of the PBX, we can see that there are more than just technical and regulatory constraints that limit the degree to which unbundling can effectively take place. If users are to take full advantage of unbundling, greater progress will need to be made in the areas of network management and standardization.

### Increased Portability

Miniaturization and the ability to unbundle intelligent equipment from the communication infrastructure are also increasing the portability of communication products and services. With the development of cellular phones and paging systems, for example, users can now communicate from any location.

Advances in cellular technologies, in particular, have greatly enhanced the ability to develop and deploy portable communication systems. The development of cellular technology grew out of the use of radio communication technologies in World War II. By the late 1940s and early 1950s, some radio common carriers and a few businesses, having been granted licenses and allocated radio frequency by the FCC, began to offer modest, local mobile communi-

<sup>110</sup>As Huber notes: "Vigorous competition in the PBX market developed between 1979 and 1982, during which period AT&T's share of the market dropped from almost 70 percent to under 30 percent." Huber, op. cit., footnote 71, p. 16.5. Although the BOCS are prohibited from manufacturing customer premises equipment, they are important distributors of PBXs and PBX-related equipment.

<sup>111</sup>For a discussion, see Barry L. Marks, "The PBX Market: Past, Present, and Future." *Telecommunications*, January 1989, pp. 57-58.

<sup>112</sup>Huber, op. cit., footnote 71, p. 16.5.

<sup>113</sup>Marks, Op. cit., footnote 111, pp. 57-58.

<sup>114</sup>See, for instance, James N. Budway, "PBXs From Riches to Rags," *Telecommunications*, November 1988, pp. 101-102.

<sup>115</sup>For discussions, see Valovic, op. cit., footnote 62, pp. 67-70; and "Opportunities for CO Services," *Telephony's CO Services Special*, May 1989, pp. 1-28; Martin Pyykkonen, "Centrex Now, ISDN Later," *Telecommunications*, February 1987, pp. 53-84; and John R. Abrahams, "Centrex Versus PBX: The Battle for Features and Functionality," *Telecommunications*, March 1989, pp. 27-32.

<sup>116</sup>For example, over 80 percent of new digital PBXs have data switching capabilities. Moreover, these switches can perform extensive protocol conversion, and they support both synchronous and asynchronous transmission for electronic mail, file sharing, terminal-to-terminal, and terminal-to-host communication. For a discussion of the relationship between the PBX and ISDN, see Tibor G. Szekeres, "Will ISDN Make the PBX Obsolete?" *CommunicationsWeek*, Sept. 19, 1988, p. 16.

cation services. \*17 Over the past 30 years, a number of different services have been developed, including radio paging; telephone-answering services; mobile telephones; private, two-way radio dispatch systems; citizen band two-way radio; public air-to-ground radio telephone service; and voice-mail services.<sup>118</sup>

Although regulatory barriers retarded the development of cellular technology for a number of years, cellular mobile telephone service is currently available in most cities.<sup>119</sup> High-power satellites can track mobile units on Earth, making nationwide mobile telephony possible. Although mobile communication is now primarily focused on car telephones, efforts are being made to create portable equipment that would permit communication with anyone, anywhere, at any time. Motorola Inc. has already introduced a new cellular telephone that can fit easily into a pocket or purse. And pagers have been transformed from simply tone-only alerts to portable electronic mailboxes.<sup>120</sup> Many industry analysts predict that people will soon be able to carry an entire portable telecommunication center with them wherever they go.<sup>121</sup>

Advances in cellular technology are finding their rewards in the marketplace. In 1988, for example, the cellular telephone industry's customer base increased by 68 percent, a rate that is likely to continue, if not increase, over the next 5 years.<sup>122</sup>

This demand will be fueled by a continued decline in prices. Reflecting these gains, the per capita value of the top 20 cellular licenses increased from \$16.23 to \$77.71 between 1985 and 1987, a figure that is expected to climb to \$100 by the early 1990s.<sup>123</sup> Annual revenues for the entire U.S. cellular industry totaled \$1.15 billion in 1988.<sup>124</sup>

How far cellular technology can evolve to meet the rising demand for portability will depend in part on how the public spectrum is allocated in the future. Although cellular technology was originally seen as a spectrum-saving technology, its deployment, like that of American highways, has typically generated more use than the capacity it created. Although the FCC recently agreed to grant the industry additional spectrum, most industry pundits fear these allocations will not suffice.

A second factor that could diminish the future prospects of cellular technology is standardization. Believing that standards may discourage technological innovation, the FCC has decided to back away from setting standards in this area. \*25 However, without standards it will be difficult, if not impossible, to establish a nationwide cellular network. If each operator is free to divide up his or her 25 megahertz, and to decide which particular radio technique to use, there will be no way to assure that one operator's system would be compatible with another's.<sup>126</sup>

<sup>117</sup>Clifford A. Bean, "Trends in Mobile Communications," *Telecommunication*, January 1989, pp. 72-75. These services were generally limited to metropolitan areas. It should be noted that the development of cellular radio suffered from considerable regulatory delay. See George Calhoun, "The Next Generation of Cellular Radio," *Telecommunications*, June 1988, pp. 41-45.

<sup>118</sup>Ibid.

<sup>119</sup>The first commercial cellular mobile telephone service was deployed by Ameritech in 1983. For discussions about the diffusion of this technology, see "Spreading Mobility," *Communications International*, August 1987, p. 8; "America Goes Mobile," *Communications International*, September 1987, p. 22; Rodney Gibson, Gerard MacNamee, and Sunil Vadgama, "Universal Mobile Telecommunication System—A Concept," *Telecommunications*, November 1987, p. 23; and Filip Linden, Jan Swerup, and Jan Uddenfeldt, "Digital Cellular Radio for the 1990s," *Telecommunications*, October 1987, pp. 254-265.

<sup>120</sup>Margie Semilof, "The Upscaling of a Basic Carry out Item," *CommunicationsWeek*, CLOSEUP, Apr. 8, 1988, p. C4.

<sup>121</sup>See, for instance, James L. Johnson, "The Times They Are A Changing," *CommunicationsWeek*, June 5, 1989, p. 12; see also Semilof, op. Cit., footnote 120, pp. C4-C5; and Frank Grimm, "Towards the Universal Mobile Telecommunication System," *Telecommunications*, November 1987, p. 9.

<sup>122</sup>Johnson, op. cit., footnote 121, p. 12.

<sup>123</sup>Maribeth Harper, "Will the RHCS Devour the Cellular Industry?" *Telephony*, July 11, 1988, p. 26.

<sup>124</sup>Candee Wilde and Glenn Abel, "McCaw Bid Jolts Industry," *CommunicationsWeek*, June 12, 1989, p. 62.

<sup>125</sup>The Europeans, in contrast, are taking a more deliberate approach to the pursuit of cellular standards. For a discussion, see Stephen Temple, "Pan-European Cellular Standards Lead the Way," *Telecommunications*, November 1987, pp. 28, 91. In the 1990s, Europe will comprise the single largest cellular radio market in the world. Most recently, Plessey has announced plans to begin constructing a wireless public switched telephone network for the entire United States, based on an enhanced version of the European Group Special Mobile digital cellular radio standard, which supports cheap, pocket-sized handsets. See Graham Finnie, "Plessey Unveils Wireless PSTN," *Telecommunications*, June 1989, pp. 29-30.

<sup>126</sup>George Calhoun, "The Next Generation of Cellular Radio," *Telecommunications*, June 1988, pp. 41-45.

## Improved Ease of Use

As technologies become more sophisticated and communication systems more complex, it will be important to develop system interfaces that make it easier for individuals to interact with technology in human terms. This means creating machines that can see, speak, hear, and reach conclusions much the same as people do.<sup>127</sup> Failure to develop user-friendly systems will increase the risk of error, which could have serious consequences in a society that is increasingly communication dependent. Fortunately, many new communication devices, ranging from video cameras to private data networks, are now being designed for operation by nontechnical users.

Until recently, computer technology was the exclusive province of a narrow technological elite. The use of computers required a special set of skills and knowledge possessed by highly trained computer scientists and a select group of self-educated computer hobbyists. Advances in hardware design and operation, as well as improvements in software design and applications, have now brought computer technology closer to the general public. Further progress is likely in the future with the development of natural language processors that will allow people to direct computers by conversing with them.

Searching online computerized databases was also done until recently by trained information specialists, such as librarians or technical specialists employed by large companies. Such searches not only required the use of highly specialized and arcane computer commands; users also needed a highly specialized knowledge of the databases themselves. More accessible software designed to reach online databases now makes it much easier to retrieve information using personal computers. Similarly, improvements in the design interface of online systems are making it easier to search and locate information.

Advances in speech processing and its integration into computer and communication systems will play

a particularly important role in making these technologies more accessible. There are systems on the market now that can recognize isolated spoken words and phrases from a vocabulary of about 100 words.<sup>128</sup> And technologies are now being developed that can synthesize intelligible, reasonably normal speech from a written text. By the turn of the century—given the present rate of progress in the computerized analysis of natural languages, together with increased computing power—some experts think it will be possible to perform machine translation, and even re-create practical spoken conversation.<sup>129</sup>

## Increased Networking Capability

Although seemingly paradoxical, the unbundling of the communication infrastructure, in conjunction with the distribution of intelligence throughout communication systems, has led to the simultaneous reintegration of communication systems through the process of computer networking. While the proliferation of communication networks makes the communication infrastructure more flexible and responsive to some users' particular needs, it could serve to limit communication access if it reduces overall system connectivity.

A computer network is a collection of computers that communicate with each other using common protocols. The computers may be microcomputers, commonly used in homes and businesses, or they may be larger minicomputers, mainframes, or supercomputers. Transmission can be provided using coaxial cable, optical fiber, satellite links, twisted pair, or telephone lines. Connections between hosts can be limited to a local area (local area networks, or LANs), or they may provide long-haul connectivity (wide area networks, or WANs). Employing such systems, data in the form of text, voice, and video can, in principle, be stored, modified, and exchanged by anyone, anywhere on the planet.<sup>130</sup>

Computer networks offer a number of benefits.<sup>131</sup> At a minimum, they can provide electronic mail and

<sup>127</sup>Ross, *Op. cit.*, footnote 26, P. 27.

<sup>128</sup>For discussions, see Paul Wallich, "Putting Speech Recognizers to Work," *IEEE Spectrum*, April 1987, pp. 55-57; Torbjorn Svendsen, "Speech Recognition: An Overview," *Telecommunications*, December 1987, pp. 37-40, 65; Ben Hoh, "Beyond the Old Frontiers: Voice Processing Technology Enters the Third Generation," *Telephony*, Jan. 23, 1989, pp. 42-44; and Robert Rosenberg, "Speech Processing: Hearing Better, Talking More," *Electronics*, Apr. 21, 1986, pp. 26-30.

<sup>129</sup>Ross, *Op. cit.*, footnote 26, p. 9.

<sup>130</sup>For a detailed description of computer networks, see Andrew S. Tannenbaum, *Computer Networks* (Englewood Cliffs, NJ: Prentice-Hall, 1981).

<sup>131</sup>See Peter Denning, "The Science of Computing: Computer Networks," *American Scientist*, vol. 73, 1985, pp.127-129.

news services.<sup>132</sup> They can also provide remote processing, allowing any computer in the network to access computer programs stored on any other host. Network users can also gain remote access to supercomputers to do advanced graphics, chip design (and remote fabrication), and scientific or economic computer simulation, and can access remote databases. In addition, they can use the network to collaborate with others or to participate in computer conferences.<sup>133</sup> Perhaps the most important attribute of networks is that they can sort out people with similar interests and bring them together. This capability will become increasingly important as the problems people face become more complex and the tasks they perform become more specialized.

Given this ability to link like-minded people remotely, it is not surprising that computer networks were initially developed to meet the needs of specific groups of users. For example, ARPANET, the first computer-based message system, was set up in 1968 in the Department of Defense by the Defense Advanced Research Project (DARPA) to provide communication between computer terminals and host computers. Building on the packet-switched network technology developed by DARPA, other agencies developed specialized networks for their research communities (ESNET, CSNET, and NSFNET). Meanwhile, other research-oriented networks, such as BITNET and Usenet, were developed in parallel by academic and industry users who, not being grantees or contractors of Federal agencies, were not served by the agency-sponsored networks.<sup>134</sup> Although telecommunication and electronic industries provided technology and capacity

for these networks, they were not the innovators or promoters of these new systems.

Businesses also began to take advantage of computer networking to improve the productivity of their ever more powerful desktop microcomputers. Local area networks,<sup>135</sup> which allow users to rapidly transfer large files of information among personal computers, have been particularly popular in the business community, where they have proliferated without much thought to planning.<sup>136</sup> Describing the situation in the electric utility industry, which by all accounts is quite typical, Taylor Moore notes:

... most utilities' computers and communications systems were designed only to perform specific functions, such as supervisory control and data acquisition in transmission or distribution operations or financial accounting in corporate systems. Most were put in place fairly piecemeal as needs arose or as new technology opened opportunities to automate . . . . Most systems were installed with no-or only limited-capability to communicate with other systems. And rarely have all the systems a utility uses come from the same vendor, with compatible interconnections or standard communication protocols.<sup>137</sup>

Reflecting this increasing demand for networking, the LAN industry has grown from about \$2.6 billion in 1987 to approximately \$4.2 billion in 1988. And predictions are that in 1992, 55 to 60 percent of new personal computers acquired by Fortune 1000 companies will be connected to LANs.<sup>138</sup>

Given the unruly way in which LANs have been deployed, businesses are now confronted with the task of managing them and trying to incorporate

<sup>132</sup>The use of computers for electronic mail systems was originally constrained by the limited availability of computers. With the widespread deployment of personal computers, this is no longer the case. As Stephen A. Casswell points out, the cost of adding electronic mail for most personal computer users has dropped 200 percent in just 5 years. Stephen A. Casswell, *E-MAIL* (Boston, MA: Artech House and Gage Educational Publishing Co., 1988), p. 41.

<sup>133</sup>Interest in videoconferencing has been increasing as more inexpensive and sophisticated digital systems are being developed. The annual rate of growth in the United States has been between 25 and 30 percent. For discussions, see Mark Maltz, "A New Age of Videoconferencing," *Telephony*, June 26, 1989, pp. 30-34; and Scott Douglas, "Why Travel When You Can Call?" *Telephony*, Apr. 3, 1989, pp. 38-42.

<sup>134</sup>John S. Quarterman, *The Matrix: Networks Around the World* (Burlington, MA: Digital Press, August 1989).

<sup>135</sup>A LAN can be described as "a package of media that includes transmission devices, end-user interface units, gateways, servers, network management, hardware, software, and application software. Such networks typically provide communication between dissimilar nodes within a building, metropolitan, or campus environment." Martin Pyykkonen, "Local Area Network Industry Trends," *Telecommunications*, October 1988, p. 21. For a technical discussion, see also Ivan T. Frisch, "Local Area Networks Versus Private Branch Exchanges," *Telecommunications*, November 1988, pp. 23-26.

<sup>136</sup>For discussions of the emergence of the LAN market, see Nina Burns, "Micro Melting Pot," *Computerworld*, Nov. 2, 1988, pp. 19-20; Jennifer Samuel, "Tapping In: Data Base LANs," *CommunicationsWeek*, CLOUSEUP, Jan. 11, 1988, pp. 6, 7, 10; Jennifer Samuel, "Departmental Nets," Nov. 21, 1988, pp. C12-C13; and Timothy Haight, "LANs Abound," *CommunicationsWeek*, Feb. 6, 1989, pp. 22, 24.

<sup>137</sup>Taylor Moore, "Building a Framework for Integrated Communications," *EPRI Journal*, July/August 1988, pp. 29-35.

<sup>138</sup>Marc Cecere, "Backdoor LANs: How to Manage Unsanctioned Networks," *Computerworld*, Nov. 2, 1988, pp. 31-32.

them into larger and larger networks.<sup>139</sup> As Lee Sustar has described:

Many companies are now reaching the conclusion that these strays must be gathered back into the mainstream of corporate computing, not only for the sake of accountability but also for improved efficiency for locally networked users, some of whom are beginning to suffer from the limitations inherent in their independent status.<sup>140</sup>

These management and coordination problems are compounded by the fact that standards for high capacity fiber optic LANs, referred to as the Fiber Distributed Data Interface (FDDI), are still being developed.<sup>141</sup> Failure to develop such standards may constrain networking in the future, since the further deployment of more powerful workstations will require higher performance systems.

This trend toward networking is also increasingly evident among individual computer users. A growing number of personal computer enthusiasts, for example, now keep in touch via computer bulletin boards. These networks consist of computerized storage space, offered by a computer owner, that is used to post messages. As detailed in chapter 8, people are now using these systems to find solutions to problems, seek support from others in similar situations, or overcome loneliness.

Although communication providers did not initiate this networking craze, they are working hard to capitalize on it. Some companies, for example, provide networking services to outside users for a profit. Included are service providers such as Telenet, Tymnet, the Source, and CompuServe. Others offer interLAN networking products and services such as bridges, routers, gateways, and brouters<sup>142</sup> (see box 3-C). To better position themselves to offer connectivity, a number of LAN providers are

consolidating or forming alliances and partnerships (see table 9-3 in ch. 9). In addition, traditional telephone companies and other ISDN providers also offer solutions to the problems of wide area networking. As Tom Valovic points out:

As the LAN market matures and ISDN inches closer toward the prospect of significant commercial deployment, the question of the relationship between these two technologies is beginning to be raised in the strategic and marketing arena. ISDN is a standard without a product. LAN, despite some preliminary efforts, is still a product without a standard.<sup>143</sup>

For a summary of the major trends occurring in the LAN industry, see box 3-D.

### Increased Targeting Capability

Targeting specific messages to particular categories of people requires high capacity, easily accessible, online storage capability, together with high-speed reprocessing and editing capabilities. Taken together, many of the trends outlined above provide such capabilities, making it much easier to parse information, tailor messages, and address them to particular users and locations.

Using computers, for example, it is now relatively easy to compile and cross-reference mailing lists and telephone numbers so that direct mailers and telephone marketers can carefully target certain receivers. As described in figure 3-6, people often inadvertently register to be placed on such lists when purchasing an item or service.<sup>144</sup> Using technologies such as VCRs and pay-per-view to unbundle programming, users can also adapt mass media content to their own particular interests.<sup>145</sup> "People meters" and other improvements in audience measurement techniques allow media providers to better meet audience demand.

<sup>139</sup>Robert Craven, "The Challenge of Enterprise-Wide Internetworking," *Telecommunications*, October 1988, pp. 31-37; see also Lee Sustar, "Pulling LANS Into the Act," *Computerworld*, May 23, 1988, pp. S1-S4; Roy D. Gemberling, "Managing Linked LANs," *Telecommunications*, September 1989, pp. 67-69; and Richard Patti, "LAN/WAN Integration," *Telecommunications*, September 1987, pp. 47-54.

<sup>140</sup>Sustar, *op. cit.*, footnote 139, p. 1.

<sup>141</sup>The market for fiber optic LANs is expected to triple by 1992. Its growth is tied to the development of a LAN standard. FDDI, which specifies the use of fiberoptic cable providing speeds of 100 megabits per second, is now being developed by the American National Standards Institute. Caryn Fox, "Fiber Lan Market to Triple By 1992," *CommunicationsWeek*, Mar. 20, 1989, p. 14. For another discussion of FDDI, see Michael V. Moore and Vickie A. Oliver, "FDDI: A Federal Government LAN Solution," *Telecommunications*, September 1989, pp. 35-40.

<sup>142</sup>William Stallings, "Internetworking: A Guide for the Perplexed," *Telecommunications*, September 1989, pp. 25-30; Debbie Shimman, "Enter the Brouter: An Update on Linking LANs," *Telecommunications*, November 1988, pp. 38-41.

<sup>143</sup>Tom Valovic, "Will ISDN Replace LANs?" *Telecommunications*, September 1987, pp. 67-69; see also Martin Sinnott, "ISDN Shows Promise as a LAN Booster," *Computerworld*, May 23, 1988, p. S7.

<sup>144</sup>For a discussion, see Jeffrey Rothfeder, "Is Nothing Private?" *Business Week*, Sept. 4, 1989, pp. 74-82. See also Gary Slutsker, "Relationship Marketing," *Forbes*, Apr. 3, 1989, pp. 145-147.

<sup>145</sup>For one discussion, see Peter Ainslie, "Confronting a Nation of Grazers," *Channels*, September 1988, p. 54.

### Box 3-C—Repeaters, Bridges, Routers, and Gateways

Networks are designed in layers, starting at the bottom with hardware and moving upwards towards software applications. For example, networks built in conformance with the International Organization for Standards reference model, referred to as Open Systems Interconnection (OSI), consist of seven layers—the physical, data link, network, transport, session, presentation, and application. Where network equipment does not conform to this model, several devices can be used to achieve interoperability.

As can be seen in the figure below, there are four basic devices that can be used to interconnect networks into a larger network. These include repeaters, bridges, routers, and gateways.

#### Repeaters, Bridges, Routers and Gateways Mapped Into The OSI 7 Layer Model.

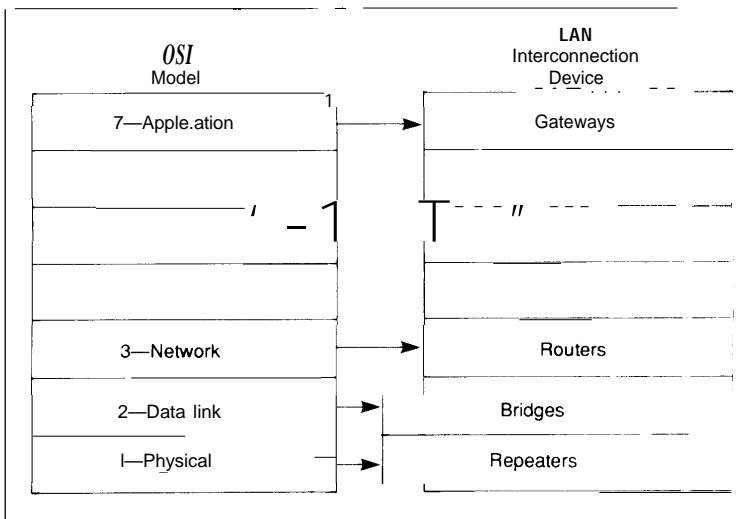

SOURCE: Reproduced by special permission of *Telecommunications* magazine.

segment of the network. Because their operations are more complex, bridges function more slowly than repeaters.

**Routers:** Routers are more intelligent than bridges. Whereas a bridge can only determine whether or not to pass a message forward, a router will determine the optimal route that the message should take. This capability reduces not only the cost of transmission, but also network congestion. Routers operate at Layer 3 of the OSI model. They are protocol sensitive, and hence can only connect LANs based on the same upper-level protocols.

**Brouters:** Brouters combine some of the bridge's functions with those of the routers.

**Gateways:** Gateways operate at the applications, or top level of the *OSI* reference model. They link dissimilar networks by translating from one set of protocols to another, thereby overcoming differences in transmission speeds, signal levels, and data format.

SOURCE: Debbie Shimman, "Enter the Brouter—An Update on Linking LANs," *Telecommunications*, November 1988, pp. 38-43. Also William Stallings, "Internetworking: A Guide for the Perplexed," *Telecommunications*, September 1989, pp. 25-30.

**Repeaters:** Repeaters are the most basic of all the tools used for internetworking. Operating at the physical layer, they re-generate signals that are transmitted across the network. Repeaters can connect local area networks (LANs) that use the same or different media, but they cannot connect them if they use different protocols. Thus, while a repeater can connect an Ethernet LAN to another Ethernet LAN, it cannot connect an Ethernet LAN to a Token Ring LAN.

**Bridges:** To connect LANs that employ dissimilar protocols requires a bridge. Bridges operate at Layer 2 of the OSI reference model, and thus they are protocol transparent. Bridges also offer some intelligence. They can filter messages to determine which ones should be forwarded to another



### **Box 3-D—Major Trends in the Local Area Network (LAN) Industry**

*Vendor consolidation:* Mergers, acquisitions, and joint ventures among traditional LAN vendors are increasing as the industry matures and vendors consolidate. Driving factors include convergence in LAN applications and products and expanding geographic network scope towards WANs (i. LAN-to-LAN integration).

*Public telephony network entrants:* Local telephone companies will increasingly offer LAN and WAN on an intra-LATA basis as central-office switches are enhanced with data networking functionality. Telcos will either be a competitor to LAN vendors or possibly a partner in serving certain key strategic end-user accounts.

*Software differentiation:* LAN software is becoming the core differentiating technical factor. Vendor strategies are based on software platforms and protocols, and user product selections are based more on software performance than the underlying hardware.

*Dual standardization-Ethernet and token ring:* Recognizing that Ethernet and token ring have different applications suitability, users are increasingly standardizing on both and then allowing individual procurements to be made between them as applications dictate. Strong product support from multiple vendors in each case reinforces the dual standardization and places vendors of proprietary standards at more of a disadvantage than previously.

*Network management:* Before the industry's vendors have been able to adequately offer network management products for a single LAN, users are demanding more sophisticated products that can manage and integrate multiple LANs over a geographically dispersed scope. Network management limitations continue to be the single most frequent reason why users limit the size and scope of LAN implementations.

*Network software performance and packaging:* Multiple software protocols and interfaces will become more commonly included in a single server or gateway interface. As protocols are embedded in a common interface or protocol stack, overall network memory requirements will be reduced and users will have more capacity for applications-specific tasks.

*FDDI emergence:* Fiber-optic technology cost/performance is becoming feasible for LAN-to-LAN backbone integration and will be feasible for linking high-power workstations within 2 years. FDDI will become established as the primary fiber LAN standard. Major vendor support is now beginning, as seen by FDDI plans announced by DEC and IBM.

*Pre-OSI acceptance of TCP/IP:* TCP/IP is rapidly becoming established as a high-performance network protocol—recently in commercial applications segments as well as the federal government for which it was originally developed. User investments will not be discarded for at least several years until OSI protocols solidify—even then, specific integration plans will have to be available to address TCP/IP-to-OSI needs.

*Workstation networks:* More LANs will be based on nonhost access needs. As early mainframe and minicomputer processing power becomes available at the desktop, LANs will serve to distribute information and computing power in high-performance workstation groups.

*LAN security:* Beyond physical transport security (e.g., encrypt}(m), LAN managers are facing growing needs to establish information security—from unauthorized internal as well as external access. As LANs proliferate so does general distribution of information, thereby compounding information security management in contrast to earlier centralized data processing environments.

Key: FDDI = fiber distributed data interface, LAN = Local area network, LATA -- local access and transport area, OSI = open systems interconnection, TCP/IP = transport control protocol/internet protocol, WAN = wide area network.

SOURCE: Reproduced by special Permission of *Telecommunications* magazine

Figure 3-6-How a Consumer's Credit File Can Travel

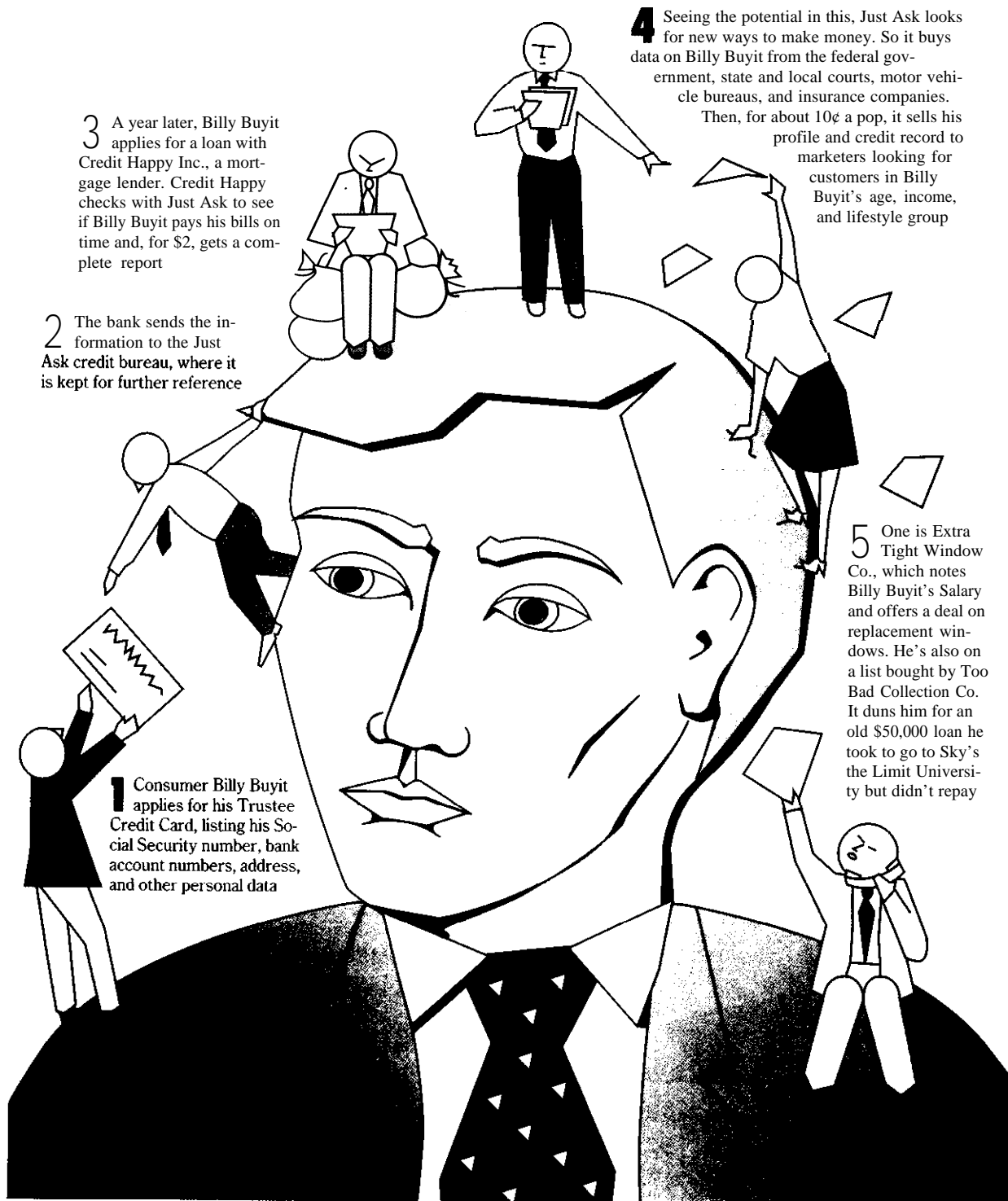

SOURCE: Reprinted from the Sept. 4, 1989 issue of *Business Week*, by special permission. Copyright 1989 by McGraw-Hill, Inc.

Targeting, however, is a two-way street. While individual users can employ targeting devices to customize the messages they receive, the transactional records they leave behind can be compiled and manipulated by others to target them for unsolicited information.

## STRUCTURAL CHANGES IN THE COMMUNICATION INFRASTRUCTURE

For almost a century, technological developments in communication supported and sustained the U.S. communication regime, which was vertically structured around distinct media. Within each industry, control flowed generally from the top down, and relationships among the key players were extremely stable.

In telecommunication, for example, the business decisions facing a central office executive were quite straightforward because relationships among suppliers and customers were rather cozy.<sup>146</sup> And telecommunication users played almost no decisionmaking role at all. The situation was not much different with respect to the mass media. Although there was no monopoly, the large film studios and the three major television networks made the key decisions, establishing programming and determining the means of its distribution.

The patterns of these relationships have now been overturned, due in part to the technological trends identified above. Given the rate of technological change, it is difficult to predict what the future might hold. Nonetheless, four major structural changes in the communication infrastructure can be discerned:

1. the globalization of the communication infrastructure,
2. the heightened importance of the large user,
3. the need for system integration and the rise of the system integrator as a key player, and
4. the multiplication of communication networks.

## Globalization of the Communication Infrastructure

With the liberalization of communication regimes worldwide, technological advances and economic developments will foster an increasingly global communication infrastructure. In the short period since the divestiture of AT&T in 1984, communication vendors and users alike have taken a number of steps that will inexorably lead to such an outcome.

Historically, U.S. needs for communication-related products and services were met domestically. However, by rupturing old relationships and the established way of doing things, the process of divestiture opened up the U.S. market to foreign countries. Many foreign firms were quick to take advantage, and understandably so. At present, the United States represents approximately one-half of the world market for telecommunication equipment and services. And the Department of Commerce estimates that by 1992 the value of this market will be around \$1 trillion.<sup>147</sup> Meanwhile, the world market is also sizable, estimated to be \$140 billion by 1992<sup>148</sup> (see table 3-6).

Technological developments are also contributing to this trend. Although advances may lower the costs of products and services in the long run, in the short run such developments can greatly increase the cost of doing business. For example, it now costs approximately \$2 billion over a 10-year period to develop a modern central office switch.<sup>149</sup> To spread these development costs, firms are expanding their markets beyond their national boundaries.

European firms have been particularly active in this regard. A good illustration is British Telecom, now the world's fourth largest telecommunication company.<sup>150</sup> In 1984, British Telecom did not boast an office outside of the United Kingdom; today, it has offices in 30 countries.<sup>151</sup> As part of its global strategy, British Telecom spent \$1.37 billion to purchase a 22-percent interest in McCaw Cellular, the largest cellular carrier in the United States. To round out its efforts, it also bought the Tymnet

<sup>146</sup>See Robert J. Cymbala, "Strategies for Global Markets," *CommunicationsWeek*, Oct. 19, 1987, p. 20.

<sup>147</sup>Jefferson Grigsby, "Global Report," *Financial World*, Apr. 18, 1989, p. 33.

<sup>148</sup>Fritz W. Ringling, "Going Global," *Telephony*, Aug. 28, 1989, p. 39.

<sup>149</sup>Grigsby, *op. cit.*, footnote 147, p. 33.

<sup>150</sup>For a discussion, see Tom Valovic, "BT Ventures Proliferate as International Markets Complicate," *Telecommunications*, September 1989, pp. 57-58.

<sup>151</sup>Grigsby, *op. cit.*, footnote 147, p. 36.

**Table 3-6-World Telecommunications Equipment Market (billions of dollars)**

	1988 actual	1989 estimated	1992 projected
Customer premises equipment . . . . .	40.0	44.0	59.0
Transmission . . . . .	23.0	22.0	19.0
Cable and outside plant . . . . .	11.5	11.0	9.0
Switching . . . . .	40.0	43.0	53.0
Total . . . . .	115.0	120.0	140.0

SOURCE: Reprinted with permission from *Telephony*, Aug. 28, 1989, p. 40

subsidiary of McDonnell Douglas Corp., thereby acquiring the second largest public data network in the United States. <sup>152</sup> Among British Telecom's other North American holdings are 51 percent of Mitel, the Canadian-based PBX manufacturer, and 80 percent of Metrocast, a national paging service. <sup>153</sup>

Ericsson, the third largest telecommunication company in Europe, has made equally impressive strides, now drawing 80 percent of its revenues from exports. Entering the mobile telephone business in the beginning of the 1980s, the Swedish company now accounts for 25 percent of the U.S. mobile telephone market and 40 percent of the world market. <sup>154</sup> While slow to enter the European telecommunication market, Ericsson has had considerable success selling in the Middle East, the Far East, and Latin America.

Given the success of Minitel in France, it is not surprising that the French have based their U.S. market debut on the future prospects of videotex and information services. <sup>155</sup> In May 1988, Minitel Services, a subsidiary of France Telecom's Intelmatique Division, was established through a joint venture between Minitel USA and Infonet. Thus, Americans with modems will now be able to access American, French, and Canadian information, entertainment, shopping, and other services.

Global acquisitions have not been limited to telecommunication. In the years since divestiture, foreign companies have spent more than \$12 billion to buy book, magazine, movie, record, and printing companies that are based in the United States. <sup>156</sup> As one industry analyst notes with a touch of irony:

Bruce Springsteen's anthems about life in America have made him a superstar, but when it comes to his record label, a Japanese company now calls the tune. <sup>157</sup>

In like fashion, the German media conglomerate, Bertelsmann AG, is today the owner of RCA Records and Doubleday Books, which publishes the prototypical American magazine classics, *Young Miss* and *Parents Magazine*. <sup>158</sup>

It is only recently that U.S. communication businesses have begun to fully explore the possibility of developing their markets abroad. One reason for the delay is that, with deregulation proceeding in foreign countries more slowly than in the United States, U.S. firms have not been able to gain access to their markets. This situation should improve in the future, as all countries are now experiencing considerable pressure to liberalize their communication regimes. <sup>159</sup> A second reason why U.S. firms have been slow to develop global strategies is that the size of the U.S. market has been generally large enough to fulfill their revenue needs. <sup>160</sup> With a saturated domestic market and increased competition from foreign suppliers, such a parochial approach is becoming harder and harder to sustain.

in response to this changing environment, a number of U.S. companies are rapidly seeking foreign partnerships and alliances. Recently, for example, AT&T entered into a major agreement with Italtel to help it modernize the Italian telephone network and to jointly produce equipment for the European market. <sup>161</sup> And the BOCs, eager to extri-

<sup>152</sup>John Williamson and Carl Wilson, "British Telecom Buys Tymnet; Expands U.S. Datacom Positron," *Telephony*, Aug. 7, 1989, p. 8.

<sup>153</sup>Ibid.

<sup>154</sup>Grigsby, op. cit., footnote 147, pp. 34-35.

<sup>155</sup>Kathleen Killete, "French Minitel Services Coming to America," *CommunicationsWeek*, Nov. 7, 1988, p. 46.

<sup>156</sup>See Ben H. Bagdikian, "The Lords of the Global Village," *The Nation*, June 12, 1989 pp. 799-819.

<sup>157</sup>Paul Farhi, "The Quiet Invasion of the Media Moguls: Global Firms' U.S. Acquisitions Raise Fears," *The Washington Post*, Nov. 27, 1988, p. H1.

<sup>158</sup>Ibid.

<sup>159</sup>Thus we see, for example, that the European Economic Commission is pushing legislation that would end state monopolies for certain telephone services. For a discussion, see M. Pyykkonen and S. Shekar, "The Impact of Europe 1992 on the Telecom Industry," *Telecommunications*, August 1989, pp. 59-60.

<sup>160</sup>For a discussion, see Ringling, op. cit., footnote 148.

<sup>161</sup>John Williamson, "AT&T, Italtel Finalize Stock Swap Agreement," *Telephony*, June 12, 1989, p. 8.

cate themselves from domestic regulatory restrictions, are now undertaking a number of international ventures. US West, for example, has joined a company from Hong Kong to bid for that country's first cable system. Pacific Telesis has joined Cable & Wireless to develop a \$350 million undersea cable to Asia. And Bell South is involved in cable enterprises throughout the world.<sup>162</sup>

Characterizing the upheaval that is taking place in an increasingly global communication environment, telecommunication analyst Tom Valovic notes:

It is increasingly an anything-goes scenario, with benefits accruing to users if, and only if, they can stop scratching their heads and start figuring out which companies they should start making alliances with. Take something as seemingly innocuous as cellular in the U.S. In Nynex's territory, there are no less than two other BOCs—Southwestern Bell and Bell South-looking for cellular business (besides, of course, Nynex). Extend that to the global market and the BOCs as a group have more irons in the fire than McDonald's has ISDN lines. Bell Atlantic, for example, is involved in upgrading Spain's public telephone network—no mean feat. But, as the British like to say, turn-about is fair play, so we should expect that the PTTs will increasingly be scouting for prospects in the BOCs backyards as well.<sup>163</sup>

### ***The Growing Importance of the Large User in Defining the Communication Infrastructure***

In the regulated environment before divestiture, communication users were extremely limited in the degree to which they could influence the communication infrastructure. The key decisionmakers were, first, the communication vendors, and second, public policy officials. As two industry analysts characterize the situation:

Typically, the major vendor (or vendors) established industry standards regarding systems architecture, product features, and incorporation of new technology, technical protocols, performance standards and pricing. These parameters became the benchmarks against which other vendors designed and marketed their own products. And so in many

respects, vendors paid more attention to one another than to the user. . . .

Government policymakers determined market participants, specified which products and services the market participants could offer, and approved the rates that could be charged for these services.<sup>164</sup>

The role of the user began to change, however, in the face of technological advances.<sup>165</sup> As described above, the dispersal of intelligence throughout the network, together with the unbundling of communication products and services, gave users much greater control. It was, in fact, the new-found ability of users to design their own equipment or create their own networks that ultimately led to the breakup of the old communication regime.

Economic developments have also supported an enhanced role for the user, especially the large-business user. With the shift toward an information-based service economy, communication is becoming more of a strategic, competitive factor in business (see ch. 6). Hence, many companies are now spending unprecedented amounts on communication services. For a service business such as Citicorp, for example, telecommunication has become the third largest cost item.<sup>166</sup> Under such circumstances, large users are far more likely to both seek and bargain for the best set of arrangements to meet their own particular needs. With a much greater stake in communication and information services, they are also more likely to organize as a group to achieve their common ends. Business users also have much greater economic clout. Approximately 50 percent of all long-distance traffic is accounted for by 5 percent of domestic and long-distance users.<sup>167</sup>

Viewing communication as a competitive weapon, business users have been quick to adapt to their new role. As detailed in chapter 6, many have opted to bypass traditional providers, devising communication networks of their own. Others have joined forces to establish user groups to design and develop their own sets of standards. Users' efforts to

<sup>162</sup>Grigsby, *op. cit.*, footnote 147.

<sup>163</sup>Valovic, *op. cit.*, footnote 150, p. 57.

<sup>164</sup>Sandra G. Tuck and Audley M. Webster, "Vendors and Users: They Need to Start Building Together," *CommunicationsWeek*, CLOSEUP, Feb. 29, 1989, p. 13.

<sup>165</sup>For a history of the changing role of the large business user, see Dan Schiller, *Telematics and Government* (Norwood, NJ: Ablex Publishing, 1982).

<sup>166</sup>Eli N., "The Public Telecommunications Network: A Concept in Transition," *Journal of Communication*, vol. 37, No. 1, Winter 1987, pp. 30-48.

<sup>167</sup>Peter Cowhey, "The Globalization of Telephone Pricing and Service," *Telecommunications*, January 1988, p. 39.

develop protocols for manufacturing and office automation are an example.<sup>168</sup>

### *Vertical Integration of Key Industry Players and the Rise of the System Integrator*

As aptly portrayed in the nursery rhyme “Humpty Dumpty,” trying to put things back together again often presents a great challenge. In the post-divestiture environment, the winners will be the vendors who do this best. As Peter Huber perceived with prescience in *The Geodesic Network*,<sup>169</sup> the demand for system solutions, one-stop shopping, and ease of management will eventually lead to the vertical reintegration of the communication industry. A number of signs already point in this direction.

One major indicator is the number of mergers and acquisitions occurring in the industry. Many businesses spawned by divestiture are now finding their situations more difficult. Not only is there more competition; users, having become more sophisticated consumers, are seeking more technically advanced and integrated solutions to their problems.<sup>170</sup> Notes Elizabeth Horwitt in this regard:

They tell me that corporate network managers are crying for Mother-Ma Bell, that is. Well, why not? In the predivestiture days, companies ordered everything from AT&T and howled for AT&T whenever there was a problem. Those were the days. Now post-divestiture has complicated telecommunications departments' lives, with an ever-shifting array of tariff structures and diverse, rapidly evolving technology. Management is simultaneously demanding strategic, reliable communications and a firmer bottom line.<sup>171</sup>

To survive in this environment, businesses are finding it necessary to team up with one another. This kind of a response is particularly evident today in the market for LANs.<sup>172</sup> Throughout the industry, the number of players has been dwindling, with all

of the major LAN companies—including Thernet, Novel, 3 Com Corp., Excelan, Sytek, Inc., Netar Inc., Interlan, and Bridge Communications—involved in at least one acquisition.<sup>173</sup>

Many companies are also taking advantage of technology convergence to enhance their overall system capabilities. Digital Equipment, for example, recently announced four new alliances designed to bolster its strength in communication. It has signed agreements with DSC Communications Corp. to develop a service control point, with Cincinnati Bell Information Systems to design and market a new cellular billing management system, with Siemens Public Switching Systems to develop and market an information service gateway for the telephone market, and with DATAP Systems to help market its operations support system for telephone company network management.<sup>174</sup> In like fashion, AT&T has offered \$250 million to purchase Paradyne Corp. in an effort to strengthen its position in the data communication marketplace.

To package their services to meet the needs of the business user, most vendors now see themselves in the role of “systems integrator.” These vendors might include the classic systems integrator, such as Computer Sciences Corp. or Electronic Data Systems Corp., as well as major computer vendors, the BOCs, the big eight accounting firms, and independent companies such as Network Management Inc., that have merged to compete with the larger vendors.<sup>175</sup> According to one analyst: “They’re all hungering for a pie that [is said] to be growing at 20 percent a year.”<sup>176</sup> As described by another:

This whole thing of network management isn’t about providing end users with what they want to see. The fight is about grabbing control of network management. He who manages the network controls the data processing center.<sup>177</sup>

<sup>168</sup>For discussions, see Stan Kolodziej, “No More Money to Burn: Industry Demands Solutions,” *Computerworld*, Sept. 7, 1988, pp. 31-M; and Mitch Betts, “MAP/TOP User Patrons Plan Crusade Expansion,” *Computerworld*, Feb. 20, 1989, p. 42.

<sup>169</sup>@ Huber, op. cit., footnote 71.

<sup>170</sup>For a discussion, see John Keller, “As the Big Get Bigger, the Small May Disappear,” *Business Week*, Jan. 12, 1987, p. 90.

<sup>171</sup>Elizabeth Horwitt, “When Others Tend Your Net,” *Computerworld*, Mar. 6, 1989, p. 66.

<sup>172</sup>IT&e Timothy Haight, “Merger Marks the Industry’s Midlife,” *CommunicationsWeek*, Apr. 3, 1989, pp. 1, 46.

<sup>173</sup>Ibid.

<sup>174</sup>Carol Wilson, “Four New Alliances Target Telcos,” *Telephony*, May 29, 1989, pp. 15-16.

<sup>175</sup>Kelly Jackson, “The Diversification of Systems Integration,” *CommunicationsWeek*, Aug. 28, 1989, pp. 22, 23.

<sup>176</sup>Mark Breitbart, “Systems Integration Surge,” *Computerworld Focus on Integration*, Feb. 4, 1989, p. 12.

<sup>177</sup>As cited in Christine Bonafield, “AT&T Targets SNA Customers,” *CommunicationsWeek*, June 20, 1988, p. 1.

### ***Multiplication of Communication Networks***

In the past, one telecommunication network existed to provide universal service to all users. This arrangement was quite suitable, as users' needs were very similar and the services that could be offered were relatively limited. Businesses used the telephone for voice communication in much the same way as households did.

Today, this is no longer the case. For many businesses, transmitting data now represents a more significant cost item than transmitting voice. Different kinds of businesses increasingly have different kinds of business needs. Thus, banks and other financial institutions have developed specialized communication services such as the Society for Worldwide Interbank Financial Telecommunications (SWIFT<sup>178</sup>), while manufacturers have developed their own communication protocols, such as manufacturing automation protocol (MAP). Even system integrators are beginning to differentiate themselves by providing specialized networking services.<sup>178</sup>

Given this increased demand for specialized communication services, together with the technical ability to unbundle and reconfigure communication systems, the number of communication networks that comprise the communication infrastructure is likely to multiply in the future. As Eli Noam has pointed out:

The emergence of technological and operational alternatives undercut the economies of scale and scope once offered by the centralized network. In the past, sharing a standardized solution was more acceptable to users because the consequential loss of choice was limited and outweighed by the benefits of the economies of scale gained. As the significance of telecommunications grew, however, the costs of nonoptimal standardized solutions began to outweigh the benefits of economies of scale, providing the incentive for nonpublic solutions. Furthermore, some users began to employ a differentiation of telecommunication services as a business strategy to provide an advantage in their customer's eye. Therefore they affirmatively sought a customized rather than a general communication solution.<sup>179</sup>

---

<sup>178</sup>Kelly Jackson, "The Diversification of Systems Integration," *CommunicationsWeek*, Aug. 28, 1989, pp. 22-24.

<sup>179</sup>Eli M. Noam, "The Future of the Public Network: From the Star to the Matrix," *Telecommunications*, March 1988, pp. 58-59, 65, 90.

**The Impact of New Technologies on  
Communication Goals and  
Policymaking**



## CONTENTS

	<i>Page</i>
INTRODUCTION . . . . .	75
THE NATURE OF GOALS AND THE GOAL-SETTING PROCESS . . . . .	76
U.S. COMMUNICATION POLICY GOALS . . . . .	78
Freedom of Speech and Freedom of the press . . . . .	79
Fostering Diversity and a Marketplace of Ideas . . . . .	83
Achieving Efficient, Interconnected Communication Services . . . . .	88
Universal Service and Equitable Access . . . . .	94
Communication in Support of National Defense and National Security . . . . .	99

### ***Box***

<i>Box</i>	<i>Page</i>
4-A. Strategic Imperatives for Trend Toward Market Domination by Larger and Vertically Integrated Organizations . . . . .	89

# The Impact of New Technologies on Communication Goals and Policymaking

## INTRODUCTION

The nature of the communication infrastructure reflects the pattern of economic relationships that exists among and between key players in the communication system, as well as the public policy goals and corresponding rules that govern these relationships. In the United States, government has traditionally played a minimal role in shaping the communication infrastructure. In general, industry leaders have been the driving force in developing and promoting communication technology in the marketplace, competing among themselves for primacy. Government intervened either to induce or ratify interindustry agreements, and to temper them in accordance with public or national security needs. As one communication scholar has characterized the decisionmaking process:

Regulation is not a central driving force in the system; rather it hovers outside and to the rear of the system, reacting to problems rather than initiating policy, and generally seeming to maintain a balance among competing interests rather than promoting one specific interest.<sup>1</sup>

In the past, the goals and rules of the system, and the balance among interested parties, were generally accepted and relatively stable. Today, however, these arrangements are increasingly being called into question. Recent technological and socioeconomic developments are unraveling the U.S. communication regime as it has traditionally evolved, bringing new possibilities, new players, and new problems to the fore. Above all, questions are being raised about the goals of the communication system and about how, and by whom, future communication policy decisions should be made.

The divestiture of AT&T and deregulatory communication policies, for example, are shifting more and more decisions into the marketplace at a time when new technologies are generating new opportu-

nities in all realms of life. Some applaud these policy developments, seeing in them new possibilities for innovation and growth.<sup>2</sup> Others fear that if decisions about new technologies are made solely in the marketplace, important social, cultural, and political opportunities will be lost.<sup>3</sup>

The retreat of the government from the communication decisionmaking process at the Federal level has given rise to a number of jurisdictional issues centering on the role of the States in establishing communication policy. Jurisdictional issues have also emerged among Federal institutions, as different stakeholders have sought to gain their own advantage by structuring the decisionmaking process in their favor. In addition, the rise of transnational corporations in a global economy is blurring the boundaries between national and international decisionmaking.

If the Federal Government is to develop and execute a national communication policy appropriate for this new environment, it will need to develop, and garner widespread agreement on, a common set of up-to-date communication policy goals and strategies. This requires an examination of past goals and strategies to determine whether, given changing conditions and circumstances, they are likely to remain valid in the future. To this end, this chapter will:

- describe the nature of goals, and the manner in which they are generally established;
- identify and describe the traditional values and goals that have guided U.S. communication policy in the past;
- describe and evaluate from an historical perspective how well, and under what circumstances, communication goals were achieved in the past; and
- identify barriers or changed conditions that may make it difficult to achieve such goals today, employing similar kinds of strategies.

<sup>1</sup>Vincent Mosco, "The Communication System From a Regulatory Perspective," OTA contractor report, December 1986.

<sup>2</sup>See, for example, Eli Noam, "The Public Telecommunication Network: A Concept in Transition" *Journal of Communication*, vol. 37, No. 1, Winter 1987, pp. 30-48.

<sup>3</sup>See, for example, former FCC Commissioner Nicholas Johnson's comments on the Van Deerlin bill, in Timothy Haight (ed.), *Telecommunications Policy and the Citizen* (New York, NY: Praeger, 1981), pp. 1-8.

## THE NATURE OF GOALS AND THE GOAL-SETTING PROCESS

To understand how communication goals might affect choices about the communication infrastructure, it is necessary first to consider the nature of goals themselves and how they are established. Goals are statements of values that serve to guide decisionmakers.<sup>4</sup> They are the criteria against which choices are weighed. Goals serve to signal the bounds of acceptable behavior and to legitimate the allocations of costs and benefits associated with decisions. Individuals, organizations, and nations establish goals as a way of signaling a commitment, identifying aspirations, clarifying objectives, or integrating diverse elements through a common bonds

Goals can be general or specific, they can cover a broad or narrow range of activities, and they can be long term or short term.<sup>6</sup> Generally speaking, the less structured the organizational context, the less agreement there is likely to be on norms and values, and thus the more vague and general the goals. Similarly, goals set higher within an organizational hierarchy tend to be more generic because the views to be reconciled are more narrow and specialized. In like fashion, the more enduring goals are intended to be, the greater the number of situations and events for which they must account, and the more ambiguous and flexible they will be.<sup>7</sup>

Goals can be established in a number of ways. They may be set as part of a deliberate, formal, rational process. Or they may be established inadvertently, for example, through some administrative action.<sup>8</sup> They may even be created after the fact, as a means of synthesizing or justifying some previous activity. More often than not, however, goals are created through an informal, day-to-day process of "organizational fighting, mutual concessions, and coalition building."<sup>9</sup> Or they are determined indirectly by the cumulative behavior of individuals and

groups acting through the push-pull mechanisms of the marketplace.

The issue of whether or not to establish or significantly alter basic goals is rarely placed on decisionmakers' agendas as a formal matter, to be considered as part of a rational decisionmaking process. It is much more likely that goals will be defined, interpreted, and/or redefined in the course of their execution and implementation. Or, if goals remain inchoate, they may be determined indirectly, driven primarily by market or technological forces. To the extent that issues about goals are resolved either indirectly or from behind the scenes, one might say that, although decisions are made, the subject of goals is never really placed on the policy agenda.

Major revision of goals is discouraged by a number of factors. One of the most important is that existing goals reflect past bargains and agreements, which may have been attained only with considerable effort and expense. By formally reopening the question of goals, existing bargains and alliances may become unglued, and a new consensus around a new set of goals will need to be developed.

Organizations also become structured around goals, and their structures may serve to constrain future choices. Within organizations, decisionmakers will generally try to deal with problems in a piecemeal fashion and with well-tried solutions. As social psychologists Katz and Kahn have described it:

They [the decisionmakers] do not consider all possibilities of problem solution because it is of the very nature of organizations to set limits beyond which rational alternatives cannot go. The organization represents the walls of the maze and, by and large, organizational decisions have to do with solving maze problems, not reconstructing maze walls.<sup>10</sup>

It is, in fact, this interrelationship between organizational arrangements and goals that suggests that any

<sup>4</sup>Herbert Simon, "On the Concept of Organizational Goals," *Administrative Science Quarterly*, vol. 9, No. 1, June 1964, p. 3.

<sup>5</sup>Murray Edelman, *The Symbolic Uses Of Politics* (Urbana, IL: University of Illinois Press, 1985).

<sup>6</sup>Daniel Katz and Robert Kahn, *The Social Psychology of Organizations* (New York, NY: John Wiley and Sons, 1976), p. 479.

<sup>7</sup>See discussions in Simon, *op. cit.*, footnote 4, pp. 176-178; Katz and Kahn, *op. cit.*, footnote 6, p. 481; and Richard M. Cyert and James G. March, *A Behavioral Theory of the Firm* (Englewood Cliffs, NJ: Prentice-Hall, 1963).

<sup>8</sup>Simon, *op. cit.*, footnote 4.

<sup>9</sup>Katz and Kahn, *op. cit.*, footnote 6. For a discussion of this process, see Cyert and March, *op. cit.*, footnote 7, pp. 29-40.

<sup>10</sup>Katz and Kahn, *op. cit.*, footnote 6, p. 283.

basic change in an organization's goals will entail a corresponding change in its structure.

Decisionmakers may also avoid publicly raising issues about basic goals because of the potentially negative political consequences. The setting of policy goals generally serves to establish or reinforce the way in which scarce resources or values are distributed among members of a group or within society. By not questioning goals, or by speaking of them only in the broadest sense, decisionmakers can be held less accountable to those stakeholders who are losers in the goal-setting process.

Although it is rare that basic goals are totally revised, they are often adjusted in an incremental fashion over time to meet the requirements of changing circumstances and values. Such readjustments come about, for example, when the authority to define and refine goals through the process of rulemaking is delegated to a government agency.<sup>11</sup> Through this process, Federal administrators often have considerable leeway to "interpret" and operationalize the meaning of a law. The amount of this leeway depends on the specificity and narrowness of the law, and on the extent to which other actors are able to constrain an agency's actions. 'z

Just as issues about goals are raised by Federal agencies in the administrative process, they can also be placed on the agenda through the judicial process. In addition to adjudicating disputes, the courts have filled in the rules on "policy issues left unresolved by existing legislation, often expanding the scope of government programs in the process."<sup>13</sup> The judicial process has also been used by individuals and groups

as a means of gaining access to the policymaking process, a development that the courts have fostered by lowering standing requirements.<sup>14</sup>

It should be noted that goals, once set, can subsequently be undermined. According to the "capture" theory of regulation, for example, agency administrators become co-opted over time by the very interests whose behavior they have been established to regulate. As a result, they tend to redefine the agency's original goals in a way that is favorable to the regulated industry.<sup>15</sup> Of course, administrative agencies are more or less subject to capture, depending on the overall political climate and on the resources and behavior of other actors.<sup>16</sup>

When goals are undermined, or when they do not keep pace with changing circumstances, they may need major revisions. The neglect of fundamental changes over time will result in impotency, if not irrelevance. Signaling the need for change might be, for example, the breakdown of internal alliances, the recurrence of unsolved problems, and the emergence of powerful new players who may want to change not only the rules of the game, but the game itself.

Experience in the United States matches this general description of goal-setting. This is particularly true in the case of communication, where only a few major legislative decisions about goals have been made. Of course, the most important and enduring decision occurred within the context of a total revision of governmental affairs-at the Constitutional Convention when the delegates agreed to include within the Constitution three clauses that provided, in turn, for freedom of the press, the

<sup>11</sup>Federal agencies operate in accordance with "organic" statutes that define their specific rulemaking authority, For a discussion of rulemaking, see "Regulators and Rulemaking," ch. 4, *Regulation: Process and Politics*, Congressional Quarterly Inc., 1982.

<sup>12</sup>Many have argued that it is the administrative leeway that has led to regulatory failure and the "capture" of agencies by their clientele. As Cutler and Johnson have described it: "Regulatory 'failure' then, as we would define it, occurs when an agency has not done what elected officials would have done had they exercised the power conferred upon them by virtue of their ultimate political responsibility. Agencies would be said to fail when they reach substantive policy decisions (including decisions not to act) that do not coincide with what the politically accountable branches of government would have done if they had possessed the time, the information, and the will to make such a decision." Lloyd N. Cutler and David R. Johnson, "Regulation and the Political Process," *The Yale Law Journal*, vol. 84, No. 7, June 1975, p. 5. For another critique of the broad administrative mandate, see Theodore J. Lowi, *The End of Liberalism*, 2d ed. (New York, NY: Norton, 1979).

<sup>13</sup>R. Shep Melnick, *Regulation and the Courts: The Case of the Clean Air Act* (Washington, DC: The Brookings Institution, 1983), p. 1. For other works on the role of the courts in establishing public policy, see, for example, Abram Chayes, "The Role of the Judge in Public Law Litigation," *Harvard Law Review*, vol. 89, 1976; Owen M. Fiss, "Foreword: The Forms of Justice," *Harvard Law Review*, vol. 93, 1979; Donald L. Horowitz, *The Courts and Social Policy* (Washington, DC: The Brookings Institution, 1977); and Nathan Glazer, "Should Judges Administer Social Services?" *The Public Interest*, No. 50, Winter 1978, p. 64.

<sup>14</sup>Richard B. Stewart, "The Reformation of American Administrative Law," *Harvard Law Review*, vol. 8, 1975; see also Laurence Tribe, *American Constitutional Law* (Mineola, NY: The Foundation Press, Inc., 1978).

<sup>15</sup>For a discussion, see James L. Baughman, *Television's Guardians: The FCC and the politics of Programming, 1958-1967* (Knoxville, TN: University of Tennessee Press, 1957), pp. xiv-xv.

<sup>16</sup>As Nell and Owen point out, interest groups do not always get what they want, especially if policymakers do not behave passively in response to their activities. Roger G. Nell and Bruce M. Owen, "What Makes Reform Happen?" *Regulation*, vol 7, No. 2, March/April 1983, pp. 19-24.

protection of intellectual property, and the establishment of postal roads.<sup>17</sup> It took almost 150 years, however, before the legislature debated and established additional national communication goals, first in 1912 and 1927 with the enactment of the Radio Acts, and subsequently in 1934 with the passage of the Communications Act.

Even then, the standard that broadcast communication should serve “the public interest, convenience, or necessity” was stated so vaguely as to leave room for considerable compromise. So, too, was the goal for providing “so far as possible, to all the people of the United States, a rapid, efficient, Nation-wide, and world-wide wire and radio communication service with adequate facilities at reasonable charges;” for this definition did not provide criteria for defining adequacy and reasonableness. Although from 1976 to 1980 Congress did reevaluate communication goals, these efforts to revise the 1934 Communications Act failed for a lack of consensus.<sup>19</sup> Today, as a result—in the absence of clearly defined and consistent goals established either by the legislature or by the Executive—national communication policy is being set, for the most part, by the courts.

Despite past reticence in formally addressing communication policy goals, there are, today, a number of circumstances and considerations that might again place this subject on the agenda of key decisionmakers. As the boundaries between technologies, markets, and jurisdictions are realigned, many of the agreements and coalitions that have sustained traditional communication goals are beginning to erode. Not only is the balance of power among traditional stakeholders shifting; in addition, new players, eager to take advantage of the opportunities that new technologies afford, are entering the scene and placing new demands on the system. In this context, many of today’s problems are no longer amenable to old solutions, and efforts to resolve them may be more difficult. With the multiplication of players and the globalization of communication markets, control over the communication infrastructure is becoming increasingly dispersed.

In reevaluating communication goals, it is useful to consider how the development of new technologies has affected communication goals in the past. Communication goals have rarely been established formally at any one moment in time, but rather have been developed over time in the course of political, administrative, and economic processes. Therefore, any analysis of their evolution requires taking a broad historical approach, focusing on the values that Americans have attached to the role of communication at different times and in different circumstances.

Employing such a perspective, it becomes evident that the way a new technology evolves and the purposes for which it is deployed depend not only on the specific technical characteristics it exhibits, but also on the social context in which it emerges and the laws and public policies that exist, or are set up, to govern its use. The emergence of new communication technologies has always served to center attention on the role of communication in society. In recognizing the potential of each new technology, communication has been viewed not just as an end in and of itself, but also as a means for addressing other societal issues. In this sense, although a nation’s communication system is built of technology, organizations, and personnel, its very nature reflects major social choices and values.

## U.S. COMMUNICATION POLICY GOALS

Despite the fact that Congress has only rarely established communication policy goals on a formal, legislative basis, it is possible to identify a consistent set of U.S. goals that have endured over the past 200 years. The major goals have been:

- freedom of speech and freedom of the press,
- fostering the diversity of content and a marketplace of ideas,
- achieving efficiency and interconnection,
- nationwide universal service and equitable access, and

<sup>17</sup>Ithiel de Sola Pool, *Technologies of Freedom* (Cambridge, MA: The Belknap Press of Harvard University, 1983), pp. 16-17.

<sup>18</sup>This clause did not go unnoticed, however. “One commentator wrote shortly after the passage of the Radio Act that the inclusion of the phrase public interest, convenience, and necessity was of enormous consequence since it meant that ‘licenses are no longer for the asking.’” Eric C. Krasnow, Lawrence D. Longley, and Herbert Terry, *The Politics of Broadcast Regulation* (New York, NY: St. Martin’s Press, 1982), p. 17.

<sup>19</sup>Krasnow et al. point out, for example, that although the proposed legislation failed to pass, the debate about it did signal the Federal Communications Commission (FCC) about the new directions a number of Congressmen were considering. They note, moreover, that many of the changes proposed in the bill have subsequently been adopted as policy by the FCC. Ibid.

- . communication in support of national security and defense.

To ascertain the relevance of these goals today, and the most effective way of achieving them, this chapter will analyze each of the goals in terms of:

- the reasons, and conditions under which, they were adopted;
- the political basis of their support;
- the policy mechanisms adopted to achieve them;
- the success of these policies in achieving their ends; and
- present-day stresses and strains that may make it more difficult to employ these means or achieve these goals in the future.

### *Freedom of Speech and Freedom of the Press*

Enshrined in the first amendment, freedom of the press is perhaps the value most closely associated with communication in the United States. Applied most fully to the print media, it has consistently meant private ownership, freedom from prior restraints, virtually no content controls, and relatively limited liability for the consequences of a message. Except during times of war and social stress, this value included the right to criticize government vigorously.

This conception of press freedom has survived largely intact because of its centrality to self-government and a free marketplace. With the development of new information and communication technologies, however, questions have been raised with respect to the extent to which, and how, the first amendment should be applied to them. Some fear that if new technologies are not covered by the first amendment, American citizens' rights to free speech and a free press will suffer as more and more information is compiled, stored, and delivered

electronically.<sup>20</sup> Others contend that the development of new technologies requires a rethinking of policies to achieve traditional first amendment goals.\*'

### **Establishing the Goal of Freedom of Speech and Freedom of the Press**

To find the source of the goal of free speech and freedom of the press, it is necessary to look to the origins of printing. Introduced into an authoritarian England in 1476, printing existed under a system of strict control until nearly 1700. Society recognized the interests of the state, not those of individuals, as paramount. In keeping with this view, the monarch was sovereign—a religious leader as well as head of state. The people were not considered capable of discerning truth for themselves; thus, secular and religious leaders exercised various controls over communication. The ultimate role of the press in this system was to sustain the state.<sup>22</sup>

During the 1600s, the growth of political democracy and religious freedom, the expansion of free trade and travel, the acceptance of laissez-faire economics, and the general philosophical climate of the Enlightenment undermined authoritarianism and called for a new political concept.<sup>23</sup> Resting on an entirely different set of values, this new concept, the libertarian theory, reversed the role of the press. The press was viewed not as a means of disseminating government-approved dogma, but rather as an aid to the people in their search for truth. According to this view, the press, operating independently, should at times provide harsh criticism of government.<sup>24</sup>

The battle between authoritarian and libertarian conceptions of the press, which took generations to resolve in England, was reprised fairly quickly in the American Colonies where the libertarian view soon

<sup>20</sup>Pool, *op. cit.*, footnote 17.

<sup>21</sup>For one discussion, see Don Le Duc, *Beyond Broadcasting: Patterns in Policy and Law* (New York, NY: Longman, 1987).

<sup>22</sup>Fredrick Siebert, Theodore Peterson, and Wilbur Schramm, *Four Theories of the Press* (Urbana, IL: University of Illinois Press, 1956), pp. 9-37. Perhaps the *most odious* press control was licensing. But in 1530, Henry VIII shifted some of the licensing authority to secular authorities, and 8 years later he extended licensing to all printed materials. Licensing was later supplemented by government-sanctioned craft controls. In 1557, the Crown chartered the Stationers Co., a group of master printers who monitored and controlled competition. In other words, the government authorized a private monopoly over the means of communication.

<sup>23</sup>*Ibid.*, p. 3.

<sup>24</sup>*Ibid.*, pp. 39-57.

triumphed.<sup>25</sup> The revolutionary struggle had itself demonstrated the value of communication in public education, persuasion, and social change, and engendered a democratic view of public opinion in the emerging republic.<sup>26</sup> The fomenting and winning of the war for independence also helped create a strong public sentiment for legally protecting the press. The first amendment to the Federal Constitution, covering freedom of speech, religion, assembly, petition, and the press, forbade Congress from interfering or making any law that might abridge those freedoms. The amendment gave American newspapers a degree of liberty unknown elsewhere.<sup>27</sup>

### Interpreting and Implementing the First Amendment

Although the first amendment has served as a fundamental building block of American Government, the first major cases involving its applicability did not arise until after World War I with the introduction of the “clear and present danger” standard.<sup>28</sup> Subsequent Court interpretations of first amendment rights have ranged from a strict absolutist view (most closely associated with Justices Hugo Black and William O. Douglas), which takes the first amendment literally at face value, to a more restrictive, historicist view (espoused by Judge Felix Frankfurter), which allows for exceptions to the rule in cases such as obscenity, libel, and national security. The Court has generally adopted an intermediary stance between these two positions: while consistently holding that freedom of speech is not absolute, the Court has defined the exceptions very

narrowly.<sup>29</sup> Among the justifications used for abridging first amendment rights have been:

- the existence of a clear and present danger;
- the need to balance freedom of speech against other legitimate interests;
- the fact that the nature of speech is unprotected, as in the case of obscenity; and
- the fact that speech is made in conjunction with actions that are, themselves, subject to regulation.<sup>30</sup>

In all of these cases, however, the Court will give precedence to first amendment considerations. As Pool has described:

At a conceptual level, this weighting is expressed by the Court’s assertion that freedom of speech enjoys a “preferred position” in the law of the land. Operationally, this preferred position means that for those who claim interference with their First Amendment rights, certain procedural burdens are waived and certain usual legal presumptions are reversed.<sup>31</sup>

Resolving first amendment issues has become more difficult with the emergence, and subsequent convergence, of many new communication technologies. For example, with the development of technologies that allow many people to communicate simultaneously with one another—as in the case of electronic bulletin boards—it is no longer always clear what constitutes “speech,” “the press,” or “assembly.”<sup>32</sup>

The problem of defining first amendment rights is also compounded by the fact that it has not been applied equally or consistently to all communication

<sup>25</sup>Although British colonial authorities had tried, with modest success, to use the press as an instrument of control, they soon discovered that they needed newspapers to communicate with one another and with the people. Thus, they encouraged postmasters, presumably loyal to the Crown, to compile newspapers from official pronouncements and semi-official correspondence. There was, however, a segment of the press that occasionally needed the authorities, to the delight of readers. This group derived its support from a growing merchant class, commercial advertising, and printing contracts let by colonial assemblies. It was this latter strain of journalism, in fact, that provided an outlet for aggrieved colonists to agitate for revolution. See Thomas C. Leonard, *The Power of the Press: The Birth of American Political Reporting* (New York, NY: Oxford University Press, 1986).

<sup>26</sup>While revolutionaries spent some time harassing loyalist editors, most of their efforts were devoted to their own public information campaigns. By all accounts, the revolutionaries were vastly more imaginative and successful than the British in using information to persuade the people. Patriotic propagandists orchestrated an information campaign that disseminated news reports (often exaggerated), along with exposés of conditions in England. Robert A. Rutland, *The Newsmongers: Journalism in the Life of the Nation 1690-1972* [New York, NY: Dial Press, 1973], pp. 26-53; Edwin Emery and Michael Emery, *The Press in America* (Englewood Cliffs, NJ: Prentice Hall, 1978), p. 65-73; and John Tebbel, *The Compact History of the American Newspaper* (New York, NY: Hawthorn Books, 1969), pp. 33-54.

<sup>27</sup>Daniel Czitrom, “Goals of the U.S. Communication System. An Historical Perspective,” (OTA contractor report, September 1987).

<sup>28</sup>Gerald Gunther, *Constitutional Law Cases and Materials* (Mineola, NY: Foundation Press, 9th ed., 1975), ch. 12.

29P @ op. cit., footnote 17, p. 59.

<sup>30</sup>Ibid.

<sup>31</sup>Ibid., p. 62. AS Pool points out, at least nine different rules give first amendment rights a preferred position. These are: reducing the presumption of constitutionality; shift in the burden of proof; expedited actions; disallowance of vagueness; requirement of well-defined standards; disallowance of overbreadth; disallowance of procedural burdens, restriction on choice of means; and narrow interpretation of laws.

<sup>32</sup>For a discussion, see U.S. Congress, Office Of Technology Assessment, *Science, Technology and the First Amendment*, OTA. CIT-369 (Washington, DC: U.S. Government Printing Office, January 1988).

technologies. As Ithiel de Sola Pool has pointed out, in the United States, there have been three different regulatory systems established to deal with communication technologies.<sup>33</sup> The print media have been governed primarily by the first amendment; telegraphy and telephony by the law of common carriage; and radio and television by a specially developed broadcast law. The problem of applying the first amendment in a new technological context arises not only because new technologies have been developed that do not fit neatly into these three categories, but also because, with the convergence of print, carrier, and broadcasting technologies, the categories themselves do not always apply.

### First Amendment Tensions: The Case of Cable

The case of cable television can serve to illustrate both of these problems. No recent technology has had such a topsy-turvy development or regulatory history. Although cable has constituted a part of the U.S. communication system for four decades, it is only recently that it has emerged as a key element in the system.

The original goal of community antenna television (CATV) was to provide a practical way of enhancing television signals for communities located on the fringe or outside of good broadcasting reception.<sup>34</sup> Throughout the 1950s, the Federal Communications Commission (FCC) essentially ignored CATV, viewing it as a temporary development and a mere auxiliary to the broadcasting system.<sup>35</sup> Seeking to avoid the administrative burden of regulating another industry, the FCC pointed out that CATV was neither a common carrier (because the subscriber did not determine the nature of the signal being carried) nor a form of broadcasting (because signal transmission was completely by wire). Thus, what attention the FCC did pay to CATV in the early years centered on possible interference or problems for the broadcast service.<sup>36</sup>

This situation changed greatly in the late 1960s when small cable operators were joined by larger

systems that aimed to greatly expand their markets by importing broadcast signals. These operators could offer better service and more channels of programming. In response, broadcasters began to pressure Congress to restrict cable. They also began to buy into cable systems, gaining control of 30 percent of them by 1968. With Congress and the courts unwilling to control the development of cable, the FCC reluctantly issued a series of rulings in the 1960s, which had the cumulative effect of restricting cable development. The period from 1968 to 1972 was thus marked by a curtailment of cable in major markets.<sup>37</sup>

In 1972, the FCC issued the *Cable Television Report and Order*, offering for the first time a somewhat comprehensive set of rules on cable. Cable systems were freed to expand to the top 100 markets, but they continued to be restricted in terms of the number and kinds of signals they could carry. Cable also had to provide channels for educational institutions, municipal governments, and public access. The cable industry began to expand in the mid-1970s when several court decisions forced the FCC to relax some of these constraints, but its growth was still limited because it was difficult for cable companies to get financing to lay cables.

Two factors served to stimulate the industry in the 1970s and 1980s.<sup>38</sup> First, the rise of pay-cable services such as Home Box Office (HBO) revealed an extensive latent demand for alternative programming. These channels charged a premium above the basic monthly cable rate, offering schedules dominated by old movies, live sports, and entertainment specials. Secondly, and more important in the long run, cable programming was linked to satellite for the first time in 1975 when Time, Inc. (owner of HBO) established the first national network to distribute cable programs to local operators. The success of RCA's and Western Union's communication satellites created reliable and economically feasible distribution networks for the cable companies. The availability of new and specialized pro-

<sup>33</sup>Pool, op. cit., footnote 17.

<sup>34</sup>After World War II, the typical early CATV company would build a tall master antenna on a hill or mountain to pick up the faint signals from a nearby city. These signals were amplified and fed into coaxial cables ultimately connected to the homes of people subscribing to the service.

<sup>35</sup>For a discussion of the FCC and the regulation of cable, see Don Le Due, *Cable Television and the FCC: A Crisis in Media Control* (Philadelphia, PA: Temple University Press, 1973).

<sup>36</sup>CATV posed a potential threat to the FCC's vision of a localized television system because if cable operators began to import distant signals into local markets, they might drive local stations out of business. However, in the early years of cable, this danger appeared to be minor. Ibid.

<sup>37</sup>Not surprisingly, opposition to cable expansion from broadcasters weakened as more and more broadcasters bought into cable systems.

<sup>38</sup>Czitrom, op. cit., footnote 27.



gramming in turn stimulated a new demand for cable systems around the country. By 1980, 22 percent of American TV households had become cable subscribers.<sup>39</sup>

As the cable industry's fortunes improved, and as more and more programming services became available, cable operators sought to legitimize the idea that, as an industry, cable was more analogous to the newspapers than it was to broadcasting; hence it should be deregulated and have the benefit of full first amendment rights.<sup>40</sup> Cable's apparent unlimited channel capacity lent considerable credibility and support to this point of view because spectrum scarcity has provided the major rationale for broadcasting regulation.<sup>41</sup> Cable's perspective also gained sustenance from an increasingly deregulatory policy climate. Commenting on the growing tension within the regulatory framework, Laurence Tribe noted:

The clear failure of the "technological scarcity" argument as applied to cable television amounts to an invitation to reconsider the tension between the Supreme Court's radically divergent approaches to the print and electronic media. Indeed, since the scarcity argument makes little sense as a basis for distinguishing newspapers from television even in the late 1960s and early 1970s, such reconsideration seems long overdue.<sup>42</sup>

Taking all of these developments into account, the Cable Communications Policy Act of 1984 was intended to reduce some of these tensions. Nevertheless, considerable confusion about the nature of cable—what it is and how it should be dealt with by

government—was embodied in the **act** itself. For example, the Cable Act substantially deregulated the industry. Cities lost the authority to regulate subscribers' rates, and they no longer had much discretion with respect to franchise renewal. The Cable Act also prohibited the future regulation of cable as a common carrier or public utility. However, at the same time, cities were permitted not only to charge franchise fees, but also to require public **access** channels and certain kinds of programming.

Such ambiguity is perhaps not surprising, given that such laws are generally the product of stakeholder compromise. In the case of the Cable Act, a compromise was developed based on the cities' desire to charge franchise fees and the cable operators' wish to greatly facilitate the franchise-renewal process. But the compromise, in effect, sidestepped the issue of the first amendment.

Although separated from the political fray, the courts have been no more successful than legislators in clarifying cable's position in the present regulatory structure.<sup>43</sup> Although the Supreme Court has ruled in the case of *Preferred Communication v. City of Los Angeles* that cable actions have first amendment implications, it has failed to specify what these implications are.<sup>44</sup> Moreover, in the few years since the Cable Act was passed, a number of courts have come to contradictory conclusions about the extent of the cable industry's first amendment rights.<sup>45</sup> Judges in Palo Alto and Santa Cruz, CA, for example, have asserted that cable companies are entitled to the same rights as the print media,

<sup>39</sup>*Ibid.*

<sup>40</sup>For cable's argument as to why it should enjoy first amendment rights, see G. Shapiro, P. Kurland, and J. Mercurio, *Cablespeech: The Case for First Amendment Protection* (New York, NY: Harcourt Brace Jovanovich, Publishers, 1983).

Throughout cable's history, a number of people have suggested that it be treated as a common carrier, an idea that cable companies have fiercely resisted. In 1970, for example, the Sloan Commission on Cable Television toyed with the common-carrier approach, but concluded that if cable companies were given common-carrier status, they would not have enough economic incentive to develop **their** systems. Pool, *op. cit.*, footnote 17, p. 169.

<sup>41</sup>The Supreme Court upheld the constitutionality of broadcast regulation in the case of *Red Lion Broadcasting Co. v. FCC on the grounds that* "broadcast frequencies constituted a scarce resource whose use could be regulated and rationalized only by government. Without government control, the medium would be of little use because of the cacophony of competing voices, none of which could be clearly and predictably heard." 395 U.S. 367, 23 L. ed. 2d 371, 89 S Ct 1794 (1969), quote as cited by Pool, *ibid.*, p. 130.

<sup>42</sup>Tribe, *Op. cit.*, footnote 14, p. 699.

<sup>43</sup>Pool has described the Court's early role with respect to cable. As he notes: "The courts, however, were not **totally** supine. Though they gave the FCC a long leash, in bursts of occasional vigilance they puzzled about where the limits of its regulatory authority might lie. Early decisions seemed to give the FCC almost unlimited power over cable systems. Later decisions began to question that authority and to overturn a number of cable rules." Pool, *op. cit.*, footnote 17, p. 160.

<sup>44</sup>111986, the Supreme Court sent the case of *Preferred Communication* back to the district court for trial. In so doing, it said that cable television's activities "implicated First Amendment interests," but added that where a cable system's "speech and conduct are joined in a single course of action," first amendment rights "must be balanced against social issues." The Court left open the question of how to judge first amendment challenges.

<sup>45</sup>For discussions, see John Wolfe, "conflicting Rulings on Cable Rights Set Stage for Supreme Court Showdown," *Cablevision*, Sept. 28, 1987, pp. 32-33; "Of Cable and Courts, Franchising and the First," *Broadcasting*, May 22, 1989, pp. 69-71; Craig Kuhl, "Franchise Fees Struck Down," *Cablevision*, Nov. 7, 1988; and "First Amendment Claims by Erie Cable Left Dangling by U.S. Appellate Court," *Broadcasting*, Aug. 8, 1988, p. 42.

whereas in Erie, PA, the court has ruled that the requirement of local public access channels was constitutionally sound.<sup>46</sup>

Quite in keeping with cable's mercurial history, the issue of cable regulation and its relationship to the first amendment is not likely to disappear. Given the industry's rising prices and increased levels of concentration, there are, for example, a growing number of people who now believe that the role of cable in the communication system needs to be reconsidered.<sup>47</sup> And some of the most recent first amendment cases have not been in cable's favor. The pressure to resolve this issue is likely to mount, moreover, as telephone companies seek to enter the business, perhaps on a common-carrier basis.

### *Fostering Diversity and a Marketplace of Ideas*

*The goal* of fostering diversity of content and a marketplace of ideas is closely associated with the first amendment objectives of free speech and a free press. Whereas the former goal is aimed at preventing government interference with and control over the media, the latter seeks to foster public access to a broad range of information content. However, it should be noted that these two goals can often come into conflict.<sup>48</sup> With the advance of communication technologies, such conflicts are likely to become more prevalent and acute.

### **Establishing the Goal of Diversity and a Marketplace of Ideas**

Like the first amendment, the goal of fostering a diverse media grew out of the age of the Enlightenment with its belief in human rationality and the ability of individuals to seek out, and discern, truth

for themselves. The Enlightenment values of human equality and natural rights also lent support to this communication goal by fostering representative government, and with it the notion that citizens needed regular access to trustworthy information about public affairs. Together, these notions congealed into the influential concept of a "free marketplace of ideas." Put simply, this concept refers to the idea that communicators should be free to offer their ideas for popular acceptance in an unregulated forum; that rational human beings, exercising their faculties, will find truths in a welter of competing claims; and that only under such circumstances can the audience make informed decisions about self-government and other matters.<sup>49</sup>

In the United States, where the first amendment had firmly established distance in the relationship between government and the print media—and where common-carrier regulations had determined access to, and the operation of, telegraphy and telephony—the issue of the government's role in explicitly fostering the diversity of information content did not fully emerge until the advent of broadcasting. Unique in requiring the use of what appeared to be a very limited public spectrum, broadcasting seemed to require a regulatory structure all its own.<sup>50</sup> The general belief at the time was that, without some means of allocating the public spectrum, the airwaves would become so overcrowded and interference would become so rife as to actually preclude broadcasting.<sup>51</sup>

After debating alternative regulatory approaches for over a decade, Congress finally adopted a system that provided for the allocation of broadcast licenses

<sup>46</sup>Ibid.

<sup>47</sup>See "Of Cable and Courts, Franchising and the First," *Broadcasting*, May 22, 1989, pp. 69-71; and "Appeals Court Distances Cable from Print Model," *Broadcasting*, Aug. 7, 1989, p. 71.

<sup>48</sup>For a discussion of this conflict and an argument that makes a case for its rationality in public policy terms, see Lee C. Bollinger, Jr., "Freedom of the Press and Public Access: Toward a Theory of Partial Regulation of the Mass Media," *Michigan Law Review*, vol. 75, No. 1, 1976, pp. 142.

<sup>49</sup>John Milton's 1644 essay, *Areopagitica*, was the first Comprehensive statement of this idea, although Milton would not accord all groups full freedom of expression. An unqualified brief for this Libertarian concept of free expression was offered by John Stuart Mill in his 1859 essay, "On Liberty." In it, Mill argued that even falsehoods deserved protection, a position accepted by the U.S. Supreme Court in law governing the defamation of public officials. See John Milton, *Areopagitica* (New York, NY: Appleton-Century-Crofts, 1951), pp. 121-129; and *The New York Times v. Sullivan*, 376, U.S. 253 (1964).

<sup>50</sup>It should be noted, as Pool has pointed out, that policy makers greatly underestimated the amount of spectrum that would eventually become available. Pool, op. cit., footnote 17, pp. 113-116.

<sup>51</sup>This view was shared by policymakers and industry representatives alike. Concerned about the problems of interference, broadcasters aligned in 1922 to form the National Association of Broadcasters, whose express purpose was to get government to become more active in radio regulation. The Secretary of Commerce, Herbert Hoover, described the situation at the time as "one of the few instances that I know of when the whole industry and country is earnestly praying for more regulation." As cited in Baughman, op. cit., footnote 15, p. 5. For an excellent discussion of the confusion of the air waves during this period, see Marvin R. Bensman, "The Zenith-WJAZ Case and the Chaos of 1926-27," *Journal of Broadcasting*, vol. 14, No. 4, Fall 1970, pp. 423-440.

on the basis of a broadcaster's ability to meet public-interest standards.<sup>52</sup> Accordingly, on February 23, 1927, Congress passed a new Radio Act. The act established the Federal Radio Commission (FRC), granting it the authority to issue broadcast licenses when it found that "public convenience, interest, or necessity would be served by the granting thereof."<sup>53</sup>

This goal of broadcasting in the public interest was subsequently incorporated, almost verbatim, into the Communications Act of 1934. Employing the phrase that had first been used in an 1887 Illinois railroad statute, legislators called on broadcast regulators to determine their policies and administrative actions on the basis of what would best serve the "public interest, convenience, or necessity." What this phrase actually implied for policymakers, however, was left quite vague. Commenting on the looseness of this phrase and the problems that might be entailed in interpreting it, Don R. Le Duc notes:

[While] it would seem relatively easy to decide when the extension of a rail line or an increase in shipping tariffs might ultimately serve the needs or interests of its customers, it was far more complex and less precise in outcome to make a similar determination in terms of audience requirements, about the factors as sophisticated and subtle as programming balance or local orientation.<sup>54</sup>

To implement this policy goal, Congress delegated authority to the newly created Federal Communications Commission. Set up as an independent regulatory commission, in the political fashion of the times, the FCC was authorized to use its licensing authority to gain broadcasters' compliance.<sup>55</sup> In accordance with this mandate, the FCC was to allocate broadcast licenses not just on the

basis of a station's technical, legal, and financial qualifications, but also on the basis of its commitment to provide programming that responded to community needs. The FCC could, moreover, rescind a station's license if, after a 3-year period, the station had failed to live up to its programming commitment. As part of their responsibility to serve the public interest, broadcasters were also required to seek out controversial issues of public importance and to present them in a balanced, objective fashion, in accordance with the Fairness Doctrine.<sup>56</sup> In addition, under section 315 of the Communications Act, stations have to make broadcasting time available on an equal basis to all bona fide political candidates.<sup>57</sup>

The Courts, while often restraining the FCC from actions that were considered to be excessive, have generally sanctioned the structure and goals of the broadcast regulatory system. As in the case of those who had designed the regulatory structure, the notion of spectrum scarcity was a major factor influencing how members of the Court viewed broadcasting issues. Setting the tone for the future in the landmark case *Red Lion Broadcasting Co. v. FCC*, the Supreme Court considered the constitutionality of the Fairness Doctrine:

... broadcast frequencies constitute a scarce resource whose use could be regulated and rationalized only by the Government. Without Government control, the medium would be of little use because of the cacophony of competing voices, none of which could be clearly and predictably heard. [Thus] Every licensee who is fortunate in obtaining a license is mandated to operate in the public interest and has assumed the obligation of presenting important public questions fairly and without bias.<sup>58</sup>

<sup>52</sup>Concerned about the possibility of government censorship, policy makers were opposed to the European model of setting up broadcasting as a national monopoly. And the common-carrier model did not seem practical, because it would not provide broadcasters sufficient economic incentive—the same argument made later with reference to cable operators. Not surprisingly, broadcasters were as opposed to the common-carrier model as cable carriers are today. For a discussion of the national debate over options, see Pool, op. cit., footnote 17, ch. 6.

<sup>53</sup>Public Law No. 632, Sec. 11.

<sup>54</sup>Le Duc, op. cit., footnote 21, p. 10.

<sup>55</sup>An independent regulatory agency seemed preferable to having licensing authority reside within the Interstate Commerce Commission, which appeared to be too closely associated with the Roosevelt Administration. For a discussion, see Pool, op. cit., footnote 17, pp. 118-128.

<sup>56</sup>Developed by the FCC without explicit authority, many feel that the Fairness Doctrine was ratified, in effect, by Congress in a 1959 amendment to section 315 of the Communications Act. The FCC does not accept this interpretation and has repeated the doctrine.

<sup>57</sup>Benno C. Schmidt, Jr., *Freedom of the Press vs. Public Access* (New York, NY: Praeger, 1976), p. 199. Public interest standards were made more concrete in March 1946 when the FCC issued a report, "Public Service Responsibilities of Broadcast Licenses," commonly referred to as the Blue Book, which laid out new and more definite program standards. At the same time, the Commission ordered stations to submit annual statements describing sample weeks of programming, and to produce certain types of noncommercial fare. See Baughman, op. cit., footnote 51, p. 11.

<sup>58</sup>*Red Lion Broadcasting Co. v. FCC*, quote cited in Pool, op. cit., footnote 17, p. 130

## Implementing the Public Interest Standard

In the years since the FCC was first established, a number of steps have been taken to encourage the diversity of media content and the development of a marketplace of ideas. Notwithstanding these efforts, most evaluations of the FCC's performance in this area generally conclude that the agency has fallen considerably short of its regulatory goals. The explanations and accounts of the FCC's past failures have differed considerably, however. To determine what future actions, if any, the Federal Government might want to take to encourage diversity, it is necessary first to reconsider the various accounts of why the Federal Government has failed to meet its objectives in the past.

One explanation of the the FCC's failure is based on the theory of the captured regulatory agency.<sup>59</sup> Focusing, in particular, on the 1950s when the agency was involved in a number of scandals, political scientists and other social observers concluded that the FCC, much like all other independent regulatory agencies, had fallen "captive" of the industry it had been established to regulate.<sup>60</sup> And, in fact, the evidence to support such a thesis was certainly available during this period. As James Baughman has described:

If an independent agency ever needed the disinterested "experts" with whom progressives earlier had anticipated populating the commissions, it was the FCC in the 1950s. And yet, the temptations surrounding the awarding of TV franchises proved too great for the statehouse types Eisenhower named . . . A pattern did emerge of ex parte contacts: commissioners fraternizing with and accepting gifts and loans from license applicants and their lobbyists. These reports wounded the FCC's already marginal reputation for judicious behavior.<sup>61</sup>

Under these circumstances, it is not surprising that the Landis Commission, set up by President-elect

Kennedy in 1960 to assess the general performance of the independent agencies, cited the FCC specifically as a prime example of a failed agency.<sup>62</sup> As Landis wrote:

The Federal Communications Commission presents a somewhat extraordinary spectacle . . . The Commission has drifted, vacillated and stalled in almost every major area.<sup>63</sup>

While acknowledging that the capture theory may serve to explain the FCC's conduct during the period of the 1950s, others contend that it does not account for the FCC's consistent problems in the years following. In particular, this theory cannot explain the FCC's history during the 1960s when two consecutive FCC Chairmen sought quite aggressive] y to improve the quality of broadcasting.

It was, for example, during this period that Chairman Newton N. Minow took the lead in advocating broadcasting in the public interest. As noted by Baughman, in Minow's speech comparing television to a vast wasteland, he:

. . . aroused industry and public opinion . . . in a manner unprecedented for an FCC chairman. With one cleverly phrased speech, Minow emerged as the symbol of all of those who had so long been determined to reshape television.<sup>64</sup>

Claiming that he had not come to Washington to "idly observe the squandering of the public's airwaves," Minow earnestly sought to institute a number of policy changes.<sup>65</sup> During his tenure, for example, the Commission began to execute the licensing process with much greater care, even trying to bring the public into the process. And Minow tried persistently and in a number of different ways to enhance and diversify programming, pressing, for example, for the deintermixture of UHF and VHF markets, increased production of children's and educational programming, and limitations on

<sup>59</sup>See, for example, Samuel Grislov and Lloyd Musolf, *The Politics of Regulation* (Boston, MA: Houghton Mifflin, 1964), p. 25; and Robert E. Cushman, *The Independent Regulatory Commissions* (New York, NY: Oxford University Press, 1941).

<sup>60</sup>For example, House hearings conducted in 1958 and 1960 not only found the FCC totally ineffective; they also concluded that two commissioners had been guilty of establishing intimate ties to parties subject to commission proceedings Baughman, op. cit., footnote 15, pp. 14-16.

<sup>61</sup>*Ibid.*, pp. 13-14.

<sup>62</sup>James M. Landis, *Report on Regulatory Agencies to the President-Elect*, Subcommittee on Administrative Practice and Procedure, 86th Cong., 2d sess. (Washington, DC: U.S. Government Printing Office, 1960).

<sup>63</sup>As cited in Baughman, op. cit., footnote 51, p. 52.

<sup>64</sup>*Ibid.*, p. 54.

<sup>65</sup>*Ibid.*, p. 63.

television advertising.<sup>66</sup> But despite his intense efforts, Minow was not particularly successful in bringing about change.

According to critics of the capture theory, in trying to explain the FCC's problems during this later period, it is not enough to look just at the relationships between the commissioners and the industry. Far more important in accounting for the FCC's behavior are the structural problems that were built into the agency's organization itself.<sup>67</sup> Chief among these is the FCC's lack of adequate political and administrative resources to do the job assigned to it. According to James Baughman, for instance, the FCC failed because, as an independent agency, it was too weak in the face of opposition from the three branches of government. Making a similar case, Don Le Duc cites the difficulties that the FCC has had to face when trying to execute the license-renewal process in accordance with the public interest standard. As he describes:

Yet, even if the commission had been able to gather the type of information necessary to evaluate the quality of each renewal applicant's programming more effectively, it would have lacked the capacity to consider it. Only 350 of the commission's 2,000-member staff were assigned to the Broadcast Bureau, and the Renewal and Transfer Division handling these applications generally consisted of no more than two dozen full-time employees. Each year this group faced a workload of 3,000 renewals, with each television application requiring the analysis of a 21-page form prescribed by the commission, as well as accompanying exhibits prepared by the broadcaster to document statements in the form. To have added additional evidence in this review process and to have insisted that it be considered carefully before any contested renewal was granted would have imposed an impossible burden on the limited staff. Unfortunately, this is precisely what the much heralded United Church of Christ decision in 1966 did require of the commission.<sup>68</sup>

While describing many of the structural problems inherent in the FCC's organization, Le Duc also

points out an additional, and perhaps even more important, factor that has prevented the agency from achieving many of its regulatory objectives. Most of the FCC's past policies, according to Le Due, fail to take economic realities and private sector motivations into account. And in a number of cases, policies and economics have been significantly at odds with one another.<sup>69</sup> Referring, for example, to the FCC's problem in trying to influence network fare, Le Duc notes:

In theory, of course, the FCC did have the legal authority to end the practice of networking at any time by simply enacting a regulation barring the licensing or the license renewal of any station that agreed to transfer any portion of its own programming responsibilities to any other party. In practice, however, it was clear, virtually from the inception of broadcasting in the United States, that basic economics would make this simple act of public policy impossible to implement. The creation and widespread dissemination of polished mass entertainment depended on a large commitment of capital, which only a large organization could afford . . . Had either the FRC or the FCC tried to curtail this circumvention of public law intent, they would have faced not only the political opposition of the broadcast industry, but also the wrath of citizens suddenly denied access to their favorite programs because of this action.<sup>70</sup>

The consistent failure of the FCC to achieve its objectives has led many in the policymaking community to question the wisdom of trying to achieve the goal of programming diversity through regulatory means. As noted below, this disillusionment, together with the development of new technologies that expand the number of channels available for programming, has given rise to a number of tensions in the regulatory system, which focus around the issue of public interest standards for broadcasting.

### Tensions in Broadcast Regulation

Challenges to the broadcast regulatory framework first got under way during President Carter's admin-

<sup>66</sup>*Ibid.* The deintermixture policy would have designated markets as either all-VHF or all-UHF. By segregating the markets, it was designed to foster the development of UHF stations, which at the time were technically inferior to VHF stations.

<sup>67</sup>See, for instance, Baughman, *op. cit.*, footnote 51; Barry Cole and Mal Oettinger, *Reluctant Regulators: The FCC and The Broadcast Audience* (Reading, MA: Addison-Wesley, 1978); Le Due, *op. cit.*, footnote 35; Le Due, *op. cit.*, footnote 21; and *Selected FCC Regulatory Policies: Their Purposes and Consequences for Commercial Radio and Television*, CED 79-62 (Washington, DC: U.S. General Accounting Office, 1979).

<sup>68</sup>The United Church of Christ decision required the Commission to allow citizens to intervene to protest the quality of service being provided by the licensee. As Le Duc points out, as in this case, it was often the Court that increased the FCC's regulatory task. However, as he is quick to add, Congress was made quite aware of the FCC's administrative burden and did little to improve its situation. See Le Due, *op. cit.*, footnote 21, p. 55.

<sup>69</sup>*Ibid.*, p. 13.

<sup>70</sup>*Ibid.*

istration when FCC Chairman Charles Ferris initiated a deregulatory policy, much in keeping with the direction of the administration's overall policy on deregulation. These efforts only achieved their full momentum, however, during the Reagan years, when Chairmen Mark Fowler and Dennis Patrick set out to revamp the entire regulatory structure, substituting marketplace constraints in place of regulatory controls.<sup>71</sup> But just as their predecessors had found themselves limited in their ability to execute policy by virtue of the FCC's organizational structure and lack of resources, so too did these proponents of deregulation. Bearing witness to these limitations, we find today, for example, the anomalous situation in which the FCC has refused to enforce the Fairness Doctrine while key members of Congress continue to champion it, promising at the first opportunity to codify it in legislation. As described by Le Duc:

At the moment, then, the broadcast deregulation has reached an impasse. Congress refuses to release the commission from its obligation to regulate American broadcast service, while the agency refuses to discharge this obligation with any more diligence or dedication than absolutely required by law.<sup>72</sup>

This growing tension in broadcast regulation can only be resolved by considering whether government should continue to have a role in an electronic digital environment, where lack of channel capacity is no longer likely to be a fundamental issue. It is on the grounds of scarcity that broadcast regulation was first justified, and it is on the basis of the changing nature of this situation that advocates of deregulation now rest their case.<sup>73</sup>

As noted above, some of the earliest proponents of deregulation were among those who had become convinced by past FCC failures that regulation was an inappropriate way to achieve broadcast policy goals. In fact, in their analysis of the regulatory process, they had concluded that the FCC's actions had at times actually been counterproductive, as, for example, in the case of the agency's efforts to

constrain the development of cable television. There were a number of economists among these critics, and it was quite natural for them to look to the marketplace for an alternative solution. Moreover, given the growth in channel capacity with the development of cable, the problem of scarcity could no longer serve as the rationale for government involvement. In addition, a market approach seemed more in keeping with first amendment principles.

Industry players also lent their support to this new perspective, although they were much more pragmatic than principled in their enthusiasm, generally favoring only those measures that were economically advantageous.<sup>74</sup> At the same time, the political basis for the old regulatory regime—that is, the *modus vivendi* that, over the years, had been established between broadcasters and the FCC—began to disintegrate as many new media players joined the fray. Clearly, the time was ripe to try something new.

To bring about a more competitive media market, the FCC began to undo the elaborate structure of rules and regulations that had been set up over the years. Among the rules that were eliminated and redefined were:<sup>75</sup>

- *rules on advertising*: although these rules had been voluntary, the FCC eliminated all constraints on the number of minutes per hour or the spillover of paid advertising into programming;
- *rules on content*: the FCC eliminated the rules requiring that a given amount of time be devoted to different classes of nonentertainment programming (5 percent for information, 5 percent for local, and a total of 10 percent for nonentertainment programming) ;
- *ownership rules*: the FCC relaxed a number of ownership rules, including the limitation on multiple station ownership. (The limits of 7 AM, 7 FM, and 7 TV stations were increased to 12, 12, and 12); and

<sup>71</sup> For a discussion, see Martha Derthick and Paul J. @i&, *The Politics of Deregulation* (Washington, DC: The Brookings Institution, 1985); and Jeremy Tunstall, *Communications Deregulation: The Unleashing of America's Communication industry* (Oxford, U. K.: Basil Blackwell, 1986).

<sup>72</sup> Le Duc, op. cit., footnote 21, p. 30.

<sup>73</sup> See, for example, Mark S. Fowler and Daniel L. Brenner, "A Market Place Approach to Broadcast Regulation," *Texas Law Review*, vol. 60, 1982, p. 207.

<sup>74</sup> For example, while the cable industry has favored deregulation for "must-carry" rides, it still calls for a Compulsory license. Similarly broadcasters would like to dispose of the Fairness Doctrine, but they want to maintain the must-carry rules.

<sup>75</sup> Tunstall, op. cit., footnote 71, p. 146.

- *franchise renewal procedures: these procedures were modified to the benefit of incumbents.*

The effects of these deregulation policies to date have been somewhat disappointing. The experience suggests that the relationship between channel capacity and the diversity of programming is not as great as deregulation advocates had hoped for or anticipated. In fact, as Don Le Duc has pointed out, it is most likely that the increase in the number of transmission channels has served to encourage integration within the programming industry, and hence to reduce the variety of content available to the public. This outcome results from the economics of the media industry. According to Le Due, for example:

... there is virtually no correlation between the number of outlets available for dissemination of film or music and the amount of such material actually produced. Thus, for example, cable-delivered pay-TV furnished a vast new nationwide network for film distribution without having any appreciable effect on the number of new films produced each year. Instead, distributors used pay-TV competition to justify raising the network-television licensing price for existing films, a practice that is causing networks to reduce the number of films scheduled.

This high-risk, high-expense industry, with only a few unchallenged distributors and a handful of acknowledged stars, has almost an infinite capacity to absorb additional funding without expanding production. New media outlets competing with one another for this relatively constant quantity of mass entertainment material will simply continue to inflate production costs to the point where many outlets will be forced to withdraw from competition.<sup>76</sup>

This situation is not likely to improve in the future. As Jay Blumler has pointed out, in a multichannel, highly competitive media environment, the likelihood for vertical integration in the industry becomes much greater.<sup>77</sup> The strategic imperatives that Blumler identifies as being responsible for this development are listed in box 4-A. Given these trends, it would appear that the policy

problem of how to achieve diversity of content and a free marketplace of ideas has yet to be overcome.

### *Achieving Efficient, Interconnected Communication Services*

*The* notion of a “marketplace of ideas” underscores the intimate connection between the traditional values of press freedom and laissez-faire economics.<sup>78</sup> As part of this tradition, it was assumed that, in a competitive, free-market economy, communication services would be provided in an optimally efficient manner.

This combined set of notions came to be challenged only later with the development of communication technologies such as the telegraph and the telephone, which enjoyed large-scale economies and required national interconnection. For the first time a conflict appeared between the goal of establishing a free marketplace of ideas and the goal of creating an efficient, interconnected, national communication system. Thus, the telegraph and telephone first provoked what has become a lively and recurring debate about how best to organize the communication media to achieve the goal of efficiency. The debate continues today, as we try to understand and make the best use of advances in communication technologies.

### **Establishing the Goal of Achieving Efficient, Interconnected Communication Services**

The goal of providing communication services in the most efficient manner, consistent with the attainment of other communication policy goals, was formally set in the Communications Act of 1934, which called for the establishment “so far as possible, to all the people of the United States, a rapid, efficient, nation-wide, and world-wide wire and radio communications service with adequate facilities at reasonable charges.” The first recognition that government, itself, might need to take some direct measures to assure the efficiency and interconnection of service occurred earlier, however, with the development of the telegraph. For, as Richard DuBoff has noted:

<sup>76</sup>Le Due, , op. Cit., footnote 21, p.128.

<sup>77</sup>Jay G. Blumler, “The Role of Public Policy in the New Television Marketplace.” Benton Foundation Project on Communications and Information Policy Options, paper No. 1, 1989.

<sup>78</sup>The linkage between these values was already apparent in 1690 when—during a parliamentary debate about one of the last vestiges of authoritarian controls, licensing of the press—some opponents of licensing justified their position on free market grounds, Siebert et al., op. cit., footnote 22, pp. 260-263.

**Box 4-A-Strategic Imperatives for Trend Toward Market Domination  
by Larger and Vertically Integrated Organizations**

- The need to spread risk (for many programs will not succeed in the market), cover losses, and bear deficits before programs finally pay their way.
- The need to aggregate resources for large-scale production and related activity, including research, development, marketing, promotion, and sales.
- The need to operate effectively in a multi-market, domestic-global programming economy.
- A need to bring scarce, highly valued, and highly costly top talent (actors, producers, writers, directors) under one's organizational umbrella.
- Incentives to diversify, so that if certain outlets and programs disappoint, others can make up for it.
- In the case of production companies, a need to control distribution outlets in order to guarantee at least a minimal take-up of their wares.
- In the case of distributors, a need to invest in program suppliers so as more effectively to control their competitive offerings, including what they cost.
- The greater difficulty smaller companies have in raising capital in these circumstances.

SOURCE: Reprinted from *The Role of Public Policy in the New Television Marketplace*, by Jay G. Blunder, with permission from the Benton Foundation, Washington, DC.

It was in the telegraph industry that the basic unworkability of the free market on a national scale was first posed in clear and compelling terms.<sup>79</sup>

Requiring large-scale technologies and national interconnection, the telegraph posed a number of questions about how this communication industry should be organized and what its relationship to government should be. Should it be treated like the press and be privately owned? Should the system be owned and operated by the government, as was the postal service? Or should it be dealt with as a private, but regulated, common carrier? The answer was not simple, and it took some time to resolve.

Although the Federal Government had provided \$30,000 for the construction of the first telegraph lines in the United States, it declined to take control of the new technology. The government's reluctance to play a more active role stemmed, in part, from the fact that the Post Office Department, already burdened by deficits, was not inclined to assume responsibility for the Washington, DC/Baltimore line, which appeared to have only limited commercial value. Also contributing to this outcome was the fact that the inventor of the telegraph, Samuel F.B. Morse, seemed to prefer a mixed public and private

telegraph system. He not only feared that businesses would manipulate markets in a strictly private system, but also that government would use a telegraph monopoly as a weapon of despotic control.<sup>80</sup>

In the absence of active government involvement, the decision about the structure of the telegraph industry was initially made in the marketplace. Telegraph firms started stringing wires between towns of any commercial consequence. With dozens of competing telegraph companies, none in a commanding position, customers found it difficult to secure rapid, reliable transmission of their messages between distant points.<sup>81</sup> And the telegraph was quickly becoming essential to bankers, brokers, speculators, and railroads. Such businesses preferred dealing with a few reliable national firms to many small precarious ones. Consolidation was the market's answer. Western Union began absorbing competitors, emerging with a near monopoly by 1870.<sup>82</sup>

With the efficiencies of one major national telegraph company, however, came concerns about potential abuses of its power. Between 1870 and the early 1900s, Congress regularly entertained proposals to purchase the telegraph companies and place

<sup>79</sup>Richard B. DuBoff, "The Rise of Communication Regulation: The Telegraph Industry, 13 Q- 1880," *Journal of Communication*, vol. 34, No. 3, Summer 1984, pp. 52-66. Quote at p. 54.

<sup>80</sup>Richard R. John, Jr., "A Failure of Vision? The Jacksonians, the Post Office and the Telegraph, 1844- 1847," paper presented at the annual meeting of the Society for Historians of Technology, Pittsburgh, PA, Oct. 23, 1986; and Robert L. Thompson, *Wiring a Continent: The History of the Telegraph Industry in the United States, 1832-1966* (Princeton, NJ: Princeton University Press, 1947).

<sup>81</sup>Ibid.

<sup>82</sup>Richard B. DuBoff, "Business Demand and the Development of the Telegraph in the United States," *Business History Review*, vol. 54, Winter 1980, pp. 459-479.



the system under the Post Office. Western Union lobbied vigorously against the plan, deriding government incompetence and extolling free enterprise. Furthermore, Western Union suggested that government control of telegraph wires, the press associations' nervous system, would compromise freedom of the press. By tying together the two concepts of freedom of the press and free enterprise, Western Union succeeded in justifying its private monopoly.

In 1866, Congress granted privileges to telegraph companies in return for their promises to provide, in Pool's words: "service like a common carrier, namely to all comers without discrimination." In 1893, the U.S. Supreme Court ratified the telegraph's status as a common carrier and Congress legislated it in the Communications Act of 1934.<sup>83</sup>

The history of the telephone industry followed a similar pattern. Before its patents expired in 1894, the Bell System established a virtual monopoly in telephony, launching service within and between sizable cities where business use and profit seemed greatest. As a result, many communities that could not afford the expensive Bell technology went without service. The patents' expiration triggered a rush to wire towns and even some rural areas. Independent telephone companies proliferated in various forms; some were for-profit corporations, others municipal utilities, and still others little more than neighborhood projects. According to Pool, by 1902, "451 out of 1,002 cities with phone service had two or more companies providing it."<sup>84</sup> Telephone users, notably businesses, found this competi-

tion burdensome, since they had to have two or more phones—one for each system serving the community. Thus users, public utility commissioners, and the larger telephone firms themselves, notably AT&T, argued that consolidation in the industry would foster great efficiency.<sup>85</sup>

Although most telephone systems remained in private hands, cities and States increasingly expected them to operate for the public's convenience.<sup>86</sup> And State Courts upheld the extension of the public utility commissions' jurisdiction.<sup>87</sup> Responding to a serious movement for government ownership, AT&T came out in favor of its own regulation, mounting a nationwide public relations and advertising campaign, perhaps the first of its kind in the United States, AT&T argued that regulation was the only way to reduce the "wasteful competition" that had earlier plagued telegraphy.<sup>88</sup> Congress agreed. I gave the Interstate Commerce Commission regulatory authority over the medium in 1910, and shifted jurisdiction to the Federal Communications Commission in 1934.<sup>89</sup>

### Implementing Efficiency and Interconnection Goals

The regulatory agreement that Theodore Vail, General Manager of AT&T worked out in 1910 gave rise to the Bell System, which had as its operational goal, "one system, one policy, universal service."<sup>90</sup> Comprised of AT&T and its subsidiaries and affiliates, the Bell System offered a complete range of telecommunication services including re-

<sup>83</sup>Pool, op. cit., footnote 17, p. 95.

<sup>84</sup>Ibid., p. 102.

<sup>85</sup>John V. Langdale, "The Growth of Long-Distance Telephony in the Bell System, 1875-1907," *Journal of Historical Geography*, No. 2, 1978, pp. 145-159; Harry B. MacMeal, *The Story of Independent Telephony* (Chicago, IL: Independent Pioneer Telephone Association, 1934).

<sup>86</sup>Increasingly typical was the point made by the Michigan Public Utilities Commission, for example: "Competition resulted in duplication of investment, the necessity for the businessman maintaining two or more telephones, economic waste to the company, increased burden, and continuous loss to the subscriber. The policy of the state was to eliminate this by eliminating, as far as possible, duplication." Michigan Public Utilities Commission, *Citizens Telephone Co. of Grand Rapids*, P.U.R. 1921E 308,315.

<sup>87</sup>It should be remembered that concerns about the power of trusts and large corporations were at their height during this period. One increasing common way of dealing with large utility-type corporations was not to break them up, but to control them through regulation. See Douglas D. Anderson, "State Regulation of Electric Utilities," James Q. Wilson (ed.), *The Politics of Regulation* (New York, NY: Basic Books, 1980), pp. 3-41. For a discussion of this period, see also Ellis Hawley, *The New Deal and the Problem of Monopoly* (Princeton, NJ: Princeton University Press, 1989), chs. 12, 15-17.

<sup>88</sup>Pool, op. cit., footnote 17, pp. 102-103. @ AT&T's advertising and public relations campaign to demonstrate that telephony was a natural monopoly: see Marvin N. Olasky, *Corporate Public Relations: A New Historical Perspective* (Hillsdale, NJ: Lawrence Erlbaum Associates, 1987), ch. 4; and Quentin J. Schultz, "Advertising and Public Utilities, 1900-1917," *Journal of Advertising*, vol. 10, No. 4, 1981, pp. 414-448.

<sup>89</sup>Gabriel Kolko, *The Triumph of Conservatism: A Reinterpretation of American History, 1900-1916* (Chicago, IL: Quadrangle Books, 1963). According to Kolko: "AT&T realized that its long-term objectives of political stability and economic rationality could be attained only by federal regulation." Ibid., p. 180.

<sup>90</sup>L.A. Schlesinger et al., *Chronicles of Corporate Change* (Lexington, MA: D.C. Heath, 1987), p. 8. In 1913, AT&T agreed to the Kingsbury Commitment in which AT&T divested itself of Western Union, which it had acquired in 1909. In addition, AT&T agreed not to acquire any additional competing independent telephone companies and to allow "qualified" interconnection with the Bell System. N.C. Kingsbury to J.C. McReynolds, J.C. McReynolds to N.C. Kingsbury, and W. Wilson to N.C. Kingsbury, Dec. 19, 1913, in FCC, Docket No. 1, vol. 65, pp. 34-40.

search and development, equipment manufacturing and sales, local and long-distance services, as well as **access** to international transmission service.<sup>91</sup> Having a total of \$150 billion in assets in 1983, prior to divestiture, it constituted the world's largest corporation.

The regulatory framework that governed the Bell System, which remained intact for more than half a century, was decidedly American. While operating in a capitalist framework, it provided some social control over the negative impacts of the single-mindedness of the marketplace.<sup>92</sup> Moreover, taking the form of a monopoly, the Bell System provided for interoperability and was able to take advantage of economies of scale and scope.<sup>93</sup> Characterizing the Bell System as the apogee of the U.S. telecommunication "regulatory idea," Manley Irwin describes its basic form as follows:

Bell's holding company organization, its integration of utility and manufacturing, the institution of state and federal regulation, emerged as the U.S. response to the dilemmas of natural monopoly. Boundary lines separating telephone from other industries appeared immutable and long established, and the industry paced, if not controlled, the state of the communications art. . . . The relationship between state and federal regulatory institutions was marked by harmony. To accommodate the state commission's desire for minimal telephone rates, the FCC embarked on an esoteric accounting process, separations and settlements, that transferred revenues from interstate toll to local subscribers. In a word, toll subscribers subsidized local subscribers. In an era of regulatory good feeling, the telephone company was, essentially, given the power to tax. Private monopoly subject to public regulation was held as a policy model worthy of emulation if not envy.<sup>94</sup>

By most accounts, this system worked well. As Glen Robinson has pointed out:

She [Ma Bell] was held in fairly high regard. In contrast to other monopolists we've loved to hate—railroads, gas utilities, broadcast stations, and countless other enterprises with protected market positions—AT&T's monopoly seemed not only natural but relatively benign. . . . The system pioneered and developed by AT&T was justly acclaimed the world's finest. Telephone rates were comfortably affordable; furthermore, in the heyday of the telephone monopoly the rate system was generally perceived as fair. Service innovation, while not rapid, nevertheless did proceed more rapidly than in other sectors of the economy.<sup>95</sup>

Given this generally favorable impression of the Bell Telephone System, it is clear that its breakup had less to do with the perception that it had failed to implement its primary objectives, and more to do with the fact that it suddenly found itself operating in a greatly altered technological, economic, and regulatory environment. All and all, there were three major factors that contributed to its demise.<sup>96</sup>

Technological developments, for one, had a major impact on the traditional Bell System. Given the convergence of information and communication technologies, there was no longer a clear distinction between what constituted a monopoly—and hence regulated—service, and what constituted a competitive service to be provided in the marketplace. This convergence led to a changing network architecture, with the intelligence being increasingly dispersed. As a result, network unbundling was greatly facilitated. In addition, as new technologies both increased in capability and declined in cost, the barriers to entry into the telecommunication market were greatly reduced. Under these circumstances, many newcomers were able to make significant

<sup>91</sup> Angela A. Gilroy, *The American Telephone and Telegraph Company Divestiture Background, Provisions, and Restructuring*, Library of Congress, Congressional Research Service, CRS Report No. 84-58 E, Apr. 11, 1984.

<sup>92</sup> Michael D. Reagan, *Regulation: The Politics of Policy* (Boston, MA: Little, Brown, and Co., 1987). For a history of the emergence and evolution of the Bell System, see Gerald Brock, *The Telecommunications Industry: The Dynamics of Market Structure* (Cambridge, MA: Harvard University Press, 1981).

<sup>93</sup> As Richard A.K. Victor points out, "Although the [Communications] Act itself did not condone monopoly, legislators at the time acknowledged AT&T's monopoly power as they discussed provision of the bill. 'This vast monopoly,' reads the Senate Report, 'which so immediately serves the needs of the people in their daily and social lives must be effectively regulated.'" See Richard A.K. Victor, "AT&T and the Public Good: Regulation and Competition in Telecommunications, 1910-1987," Harvard Business School, unpublished paper, April 1987, revised March 1988, p. 17.

<sup>94</sup> Manley R. Irwin, "Telecommunications and Government: The U.S. Experience," in S.S. Wilks and M. Wright (eds.), *Comparative Government: Industry Relations* (Oxford, London: Clarendon Press, 1987).

<sup>95</sup> Glen O. Robinson, "The Titanic Remembered: AT&T and the Changing World of Telecommunication," *Yale Journal on Regulation*, vol. 5, 1988, pp. 517-518.

<sup>96</sup> For accounts of the Bell breakup, see Peter Temin, *The Fall of the Bell System* (New York, NY: Cambridge University Press, 1988); and Steve Coll, *The Deal of a Century* (New York, NY: Atheneum, 1986).

inroads into AT&T's traditionally protected market. Their chances for success were greatly enhanced, given that AT&T was required to provide universal service while its competitors could target products to the most lucrative business markets, and offer them at a lower price. Thus, their entry put pressure on the system of subsidy pricing that had been so elaborately constructed over the years.<sup>97</sup>

Economic developments also greatly increased the incentives for others to try to enter the telecommunication/data communication market. In particular, as information came to play an enhanced and more strategic role in the realm of business, large users began to seek alternative, more efficient ways of purchasing telecommunication services.<sup>98</sup> Where their needs were great or where they wanted more strategic control over their operations, users established their own internal telecommunication networks. In other cases, business users were able to make the best deal by bypassing the Bell System and purchasing services and equipment in the unregulated market. Because telecommunication could serve as a strategic business weapon, and since expenditures on these services constituted an increasing portion of their overall business expenses, large users had tremendous stakes in how the telecommunication regulatory structure evolved. Recognizing this fact, they joined forces with the burgeoning new service providers to press for greater competition.<sup>99</sup>

Changes were also taking place in the way the regulators thought about the regulatory structure.<sup>100</sup>

As early as 1962, a number of regulatory economists began to question the public-utility concept. Together, their work—if it did not itself give rise to the new deregulatory climate—served at least to legitimize it.<sup>101</sup> This changed attitude was evident at the FCC. As former FCC Commissioner Nicholas Johnson commented on the occasion of the FCC's decision to approve MCI's application to establish a long-distance, private-line service:

On this occasion three Commissioners are urging a perpetuation of more Government regulation of business, and four want to experiment with the market forces of American free private enterprise competition as an alternative to regulation.

No one has ever suggested that Government regulation is a panacea for men's ills. It is a last resort, a patchwork remedy for the failings and special cases of the marketplace . . . I am not satisfied with the job the FCC has been doing. And I am still looking, at this juncture, for ways to add a little salt and pepper of competition to the rather tasteless stew of regulatory protection that this Commission and Bell have cooked up.<sup>102</sup>

Although perhaps not fully cognizant of the ultimate outcome of its actions,<sup>103</sup> the FCC, in 1959, took one of its first steps toward divestiture and the Modified Final Judgment (MFJ) with its "above 890" decision. This decision, which greatly liberalized the licensing of private microwave systems, allowed the newly created Microwave Communications, inc. (MCI) to offer a new product--discount

<sup>97</sup>For a discussion, see Separations Procedures *in the Telephone Industry: The Historical Origins of a Public Policy* (Cambridge, MA: Center for Information Policy Research, 1981).

<sup>98</sup>For a discussion of the changing role of the large business users, see Dan Schiller, "Business Users and the Telecommunication Network," *Journal of Communication*, vol. 32, No. 4, Autumn 1982, p. 35.

<sup>99</sup>*Ibid.*

<sup>100</sup>For one discussion, see Alfred E. Kahn, "The Passing of the Public Utility Concept A Reprise," Eli Noam (ed.), *Telecommunications Regulation Today and Tomorrow* (New York, NY: Harcourt Brace Jovanovich Publishers, 1983), ch. 1. For an account of these changes in attitude as seen from within the regulated industry, see Temin, *op. cit.*, footnote 96, who argues that changes in ideology were in many ways more important than changes in technology. He notes, moreover, that with the emergence of competitors, the nature of the relationship between the FCC and AT&T was radically changed.

<sup>101</sup>As Roger Nell has described: "Economists generally entered the study of regulation with the naive view that regulatory institutions were set up for the purpose of rectifying market failures. Unfortunately, and almost without exception, the early empirical studies—those commencing in the late 1950s and continuing into the 1970s—found that the effects of regulation correlated poorly with the stated goals of regulation. By the early 1970s, the overwhelming majority of economists had reached consensus on two points. First, economic regulation did not succeed in protecting consumers against monopolies, and indeed often served to create monopolies out of workably competitive industries or to protect monopolies against new firms seeking to challenge their position. Second, in circumstances where market failures were of enduring importance (such as environmental protection) traditional standard-setting regulation was usually a far less effective remedy than the use of markets and incentives," Roger G. Nell, "Regulation After Reagan," *AEI Journal on Government and Society*, No. 3, 1988, pp. 13-20.

<sup>102</sup>*Microwave Communications, Inc.*, 18 FCC 2d, 953,971-972. As cited in Victor, *op. cit.*, footnote 93, p. 46.

<sup>103</sup>Although AT&T protested this sequence of events, claiming that the suffered damage through cream-skimming, the FCC minimized this problem. For a discussion, see Temin, *op. cit.*, footnote 96. Commenting on the FCC's naivete in these matters, Steve Coil points out that it was an AT&T lobbyist who first explained the implications of the Execunet decision to the FCC. See Coll, *op. it.*, footnote 96, pp. 83-85.

private-line service.<sup>104</sup> With the subsequent Carterphone decision in 1969, the FCC also opened the customer-premises market to entry. And finally, with the decisions on Execunet in 1976 and 1978, requiring AT&T to provide connections to MCI, the FCC struck a final blow to the 100-year-old AT&T monopoly by opening the long-distance telecommunication market to competition.

### Continuing Tensions Under the New Regulatory Regime

After the divestiture of AT&T on January 1, 1984,<sup>105</sup> the MFJ replaced the old regulatory framework that had governed the Bell System for so long. Based on the antitrust settlement that had been negotiated between William F. Baxter, Assistant Attorney General, and Charles L. Brown, Chairman of AT&T,<sup>106</sup> the MFJ was approved and revised by Judge Harold Greene.<sup>107</sup> The basic premise underlying the MFJ is that regulated monopoly needs to be isolated from potentially competitive, and hence potentially unregulated, markets.<sup>108</sup> Accordingly, AT&T was divested of its local telephone operations. However, it was authorized to provide long-distance telephone service and to retain Western Electric, the dominant telephone equipment manufacturer. In addition, it was to keep all of its international subsidiaries as well as Bell Labs. As a quid pro quo for its losses, AT&T was permitted to offer data transmission and processing service.

The 22 divested Bell operating companies were consolidated to form 7 regional holding companies, but they were prohibited from offering long-distance and information services and from manufacturing

customer-premises equipment. In recognition of the fact that communication technology and markets are in a state of flux, the MFJ established a waiver process as well as a process for reevaluating the structure of the market on a triennial basis. Serving as a blueprint for bringing competition to the telecommunication industry, this new arrangement was considered to be much more in keeping with the times.

While the MFJ settled the Department of Justice's antitrust suit, it could not resolve the tension between the goals of efficiency and competition that are inherent in telecommunication regulatory policy. No sooner had the affected parties agreed to the MFJ when these issues began to reemerge in the waiver process, the triennial review, and more recently in the debate about the open network architecture process and integrated services digital networks (ISDN).<sup>109</sup> Perhaps this is to be expected. For, as Roger Nell has emphasized:

Pending regulatory issues reflect an enduring characteristic of telecommunications policy: neither the pricing nor the structural issue has ever been or is likely to be resolved. The telecommunications system is not, and never was, broken. Rather, its underlying technical and economic characteristics create an enduring policy dilemma. One can regulate prices and structure to encourage maximum feasible competition, or to promote an integrated monopoly. What is infeasible is a "neutral" formulaic policy regarding prices and structure that will assure the right mix of monopoly and competition. The current policy agenda continues the futile search for better regulatory instruments, and also includes rear guard

<sup>104</sup>Allocation of Frequencies in the Bands Above 890 MHz., 27 FCC 359 (1959) 29 FCC 190 (1960).

<sup>105</sup>The *stow* of the AT&T divestiture has been widely documented, and it will not be reviewed here. For discussions and accounts, see Temin, *Op. Cit.*, footnote 96, and Coil, *op. cit.*, footnote 96.

<sup>106</sup>In 1974, the Justice Department brought an antitrust suit against AT&T, accusing it of having illegally manipulated its dominant position in all three segments of the telecommunication market in order to monopolize the whole industry. It was not until 6 years later, however, that it brought the suit to trial. Moreover, no sooner was it under way when the trial was postponed in an effort to reach a settlement. By agreeing to settle out of court, AT&T did not have to admit to any wrongdoing. In December 1981, without notice, AT&T made a settlement offer, volunteering to divest itself of its operating companies and to limit its business to long-distance and overseas operations, to the manufacture and sale of telephone equipment, and to telecommunication research. In the final agreement that was worked out, AT&T agreed to competition in long-distance service and in the customer-premise market in exchange for the freedom of entering into unregulated markets. For a detailed history, see Coil, *op. cit.*, footnote 96.

<sup>107</sup>Concerned about the eventual fate of the Bell regional holding companies, the Court added 10 amendments to the MFJ. One of these provided for the waiver process; another transferred the lucrative yellow-pages business to them.

<sup>108</sup>Roger Nell, "Telecommunications Regulation in the 1990s," Paula R. Newberg (ed.), *New Directions in Telecommunications Policy* (Durham, NC: Duke University Press, 1989), p. 16. Describing what is called the "quarantine theory," Nell notes: "In its purest form, it means preventing a regulated monopoly from participating in potentially competitive markets in order to protect the latter from the abuses encouraged by rate-of-return/residual-pricing regulation. It accepts the danger of protecting inefficient competitors who legitimately should be destroyed by the local service monopolist. In return it guarantees that inefficient monopolists will not retain a market solely by taking advantage of their regulated status. Of course, such a stark choice, one way or the other, is required if one accepts the premise that price regulation must create incentives to engage in such behavior and that regulators are ineffective (and perhaps uninterested) in preventing it." *Ibid.*, p. 31.

<sup>109</sup>These issues are described and discussed in detail in ch. 11.

actions by the people who lost the last time around—who are not, and probably cannot be convinced that deregulated competition is the best policy.<sup>110</sup>

### *Universal Service and Equitable Access*

Universal service and equitable access are relative terms whose meanings change in different times and circumstances. In the United States, for example, it was clear by the turn of the 20th century that the notion of universal service entailed equitable access to the postal system, the mass media, and the educational system, as well as to the existing services that could be provided by the telegraph and telephone. However, as the United States moves further away from an industrial era into an age where knowledge and information play a greatly enhanced role, it is no longer clear what these terms should mean. In this new environment, where the number and variety of information and communication services are continually evolving, it will be necessary to reconsider, as a society, which opportunities should be made available on a universal basis.

### **Establishing the Goals of Universal Service and Equitable Access**

Although the goal of universal service was not formally adopted until after enactment of the Communications Act of 1934,<sup>111</sup> government policymakers have promoted information distribution since the earliest days of the Republic. Officials in the newly constituted government were acutely aware that if they were to build a nation they had to establish a communication infrastructure. It was, in fact, for this reason that the Founders authorized Congress to establish a communication public utility or common carrier in the form of the postal system.

And the development and evolution of American postal policy also reflect this goal.

A sense of the post office's intended mission can be gleaned from the extensive policy debates that began with the First Congress. \*12 Most of these debates dealt with underwriting the dissemination of public information, especially newspapers. Federal officials and political theorists of the time, including Washington, Jefferson, and Madison, recognized the fragile nature of American nationalism. They doubted that a republic as geographically and socially diverse as the United States could maintain sufficient popular consensus to remain one nation. Thus Federalists and Republicans alike set aside their factional differences to rally behind a postal policy that encouraged the widespread circulation of newspapers.<sup>113</sup> Towns clamored for their own post offices to facilitate commerce and reduce isolation, and Congress usually obliged.<sup>114</sup> However, favoring the exchange of political and business information over interpersonal transactions, Congress set postage rates several times higher for letters than for newspapers.<sup>115</sup>

Another provision of postal policy—postage-free exchanges among newspaper editors—reflected similar societal values and concerns. Long before the advent of press associations, editors obtained nonlocal information by culling out-of-town newspapers, their so-called “exchanges.” In an arrangement that today's journalists might find foreign and offensive, the government in essence operated the Nation's newsgathering service. This postal privilege was of particular importance to political parties and government. Early parties maintained their cohesion and coordinated activities by sharing like-minded papers. And through exchanges, a

<sup>110</sup>Noll, *Op. cit.*, footnote 108, p. 233.

<sup>111</sup>As Ken Gordon and John Haring note, “The term ‘universal service’ appears in no public law and there is no authoritative source defining precisely what it means . . . it is a shorthand expression generally used to refer to [the policy articulated in] Title I of the Communications Act of 1934.” See Ken Gordon and John Haring, “The Effects of Higher Telephone Prices on Universal Service,” FCC Office of Planning and Policy working paper series, 1984.

<sup>112</sup>Some scholars have described the early post office as part of the revenue-raising machinery of government because of its placement in the Treasury Department (it did not become a Cabinet-level agency until Andrew Jackson's administration). But, as the following discussion makes clear, this administrative arrangement was highly deceptive. For the former perspective see, Pool, *op. cit.*, footnote 17, p. 77. See also Wesley E. Rich, *The History of the United States Post Office to the Year 1829* (Cambridge, MA: Harvard University Press, 1924), p. 113.

<sup>113</sup>The Whiskey Rebellion and other signs of the frontier's disenchantment with the central government underscored the severity of this problem. Keeping readers apprised of political intelligence, the staple of all but commercial newspapers, justified below-cost postage. For a discussion, see Richard B. Kielbowicz, “The Press, Post Office, and Flow of News in the Early Republic,” *Journal of the Early Repul.die*, vol. 3, Fall 1983, pp. 255-280.

<sup>114</sup>See Richard B. Kielbowicz, *News in the Mail: The Press, Post Office and Public Information, 1690-1863* (Westport, CT: Greenwood Press, forthcoming), ch. 3.

<sup>115</sup>*Ibid.*

small-town paper was tied to the county seat, the State capital, and the seat of Federal Government.<sup>116</sup>

The public school movement also served to boost the notion that information and knowledge should be made universally available.<sup>117</sup> Emerging in the wake of the Civil War, the commitment to public education was so intense that it gave rise to a national crusade to establish public schools. Concerned about the problems of reconstruction in the south, the influx of Catholic immigrants, and the advent of industrialization in the north, Americans saw public schooling as a way of preserving the social, economic, and political system. By educating American youth in common, public schools, they hoped to inculcate a common set of patriotic, Protestant, and republican values.<sup>118</sup> With the industrialization and urbanization of American society, it was expected that schooling would serve not only to prepare American youth for a common political role as citizens, but also to prepare a growing number of people from increasingly different social, economic, and ethnic backgrounds for an increasingly differentiated set of economic roles.<sup>119</sup>

Concerns about equity of access continued to grow in the late 1800s with the emergence of a mass

society and the mass media. The media became the most important mechanism, cutting across structural divisions and linking heterogeneous publics.<sup>120</sup> Moreover, with the trend toward national distribution and the growth in advertising as the basis for media distribution, access to the media came to be equated with access to national cultural fare and national consumer goods and markets.<sup>121</sup> The mails were crucial in delivering these publications, and the inauguration of Rural Free Delivery (RFD) in the 1890s enabled magazines to flow from publishers in urban areas to farms on country lanes.<sup>122</sup> The high cost of building roads and maintaining regular deliveries in sparsely populated areas made RFD unpopular with some lawmakers, and revenues from country post routes rarely, if ever, covered their expenses. But rural advocates pointed to the social and economic benefits derived from universal access to the postal system and, in turn, the information and goods that came by mail.<sup>123</sup>

Support for the idea of equitable access also came from social reformers, many of whom were associated with the Progressive Movement. Believing that the press mediated the flow of information and symbols among segments of society, they looked to

<sup>116</sup>Richard B. Kielbowicz, "Newsgathering by Printers' Exchanges Before the Telegraph," *Journalism History*, vol. 9, Summer 1982, pp. 42-48. At a time of limited commercial activity and a small pool of potential subscribers, a newspaper's continued survival always seemed in doubt. Political parties, often using government resources, buttressed the press. As long as the political system remained dynamic—that is, a variety of factions and viewpoints were represented in different branches of government—the system worked.

<sup>117</sup>Rush Welter, *Popular Education and Democratic Thought in America* (New York, NY: Columbia University Press, 1962).

<sup>118</sup>David Tyack and Elisabeth Hansot, "Conflict and Consensus in American Public Education," *America's Schools: Public and Private*, *Daedalus*, summer 1981; Robert A. Carlson, *The Quest for Conformity: Americanization Through Education* (New York, NY: John Wiley & Sons, 1975); "Public Education as Nation Building in America: Emollients and Bureaucratization in the American States, 1879-1930," *American Journal of Sociology*, vol. 85, No. 3, November 1979.

<sup>119</sup>To perform this economic function, the public schools were restructured in accordance with business principles. Vocational education and guidance were introduced as part of the educational curriculum. Assuming that the majority of Americans would be working at industrial jobs, educators believed that vocational education would serve not only the best interests of the individual, but also the best interests of society. For a discussion, see David K. Cohen and Barbara Neufeld, "The Failure of High Schools and the Progress of Education," *America's Schools: Public and Private*, *Daedalus*, Summer 1981; Tyack and Hansot, op. cit., footnote 118; Sol Cohen, "The Industrial Education Movement, 1906-1917," *American Quarterly*, Spring 1969, pp. 95-110; and Martin Trow, "The Second Transformation of American Secondary Education," *International Journal of Comparative Sociology*, vol. 7, 1%1.

<sup>120</sup>James W. Carey, "The Communications Revolution and the Professional Communicators," *Sociological Review Monograph*, vol. 13, January 1969, pp. 23-28; C. Wendell King, *Social Movements in the United States* (New York, NY: Random House, 1956), p. 24.

<sup>121</sup>The trend toward national distribution of printed matter culminated with the emergence of inexpensive popular magazines. Entrepreneurs launched national magazines in the 1880s and the 1890s expressly to serve as vehicles for advertising brand-name consumer items featured by mass retailers. This new genre of magazines, epitomized by Curtis Publishing Co. *Saturday Evening Post*, *Ladies' Home Journal*, and *Country Gentleman*, cut subscription rates to attract a mass middle-class audience. With advertising-filled periodicals blanketing the Nation, the heavily subsidized second-class mailings grew 20 times faster than the population in the four decades after 1880. See Theodore Peterson, *Magazines in the Twentieth Century* (Urbana, IL: University of Illinois Press, 2d ed., 1964), pp. 1-49.

<sup>122</sup>While city and village residents enjoyed daily carrier service, farm families typically picked up their mail in a weekly trip to town. The Grange and other rural groups complained about this inequality. Once RFD began in 1897, daily newspapers could be delivered to the country, alleviating rural isolation and drawing farm families into regional, national, and even international communities. For a discussion of the history of RFD, see Wayne E. Fuller, *RFD: The Changing Face of Rural America* (Bloomington, IN: Indiana University Press, 1964).

<sup>123</sup>Ibid. The early 20th-century roads movement, which finally won Federal appropriations for road construction, was both directly and indirectly linked with rural postal service. See also Daniel J. Boorstin, *The Americans: The Democratic Experience* (New York, NY: Random House, Vintage Books, 1973), pp. 118-136.

the mass media to foster peaceful social reform by connecting segments of society with the whole. They claimed that access to mass circulation publications was necessary to get their concerns placed on the national agenda. To reach a cross-section of society and influential policymakers it was no longer enough to simply issue one's own publication. To be effective, they argued, one had to get the message into the commercial press, which at the time usually meant making the groups' concerns newsworthy enough to attract the attention of reporters.<sup>124</sup>

It was within the context of these growing concerns about access to information and communication services and the uneven deployment of the telephone that regulatory issues surrounding the telephone first emerged.<sup>125</sup> Not surprisingly, Theodore Vail faced little opposition when he proposed tying the goal of universal service together with a regulatory structure legitimizing AT&T as a natural monopoly. As Vail described his vision of the telephone industry in the *Annual Report of 1910*:

The position of the Bell system is well known . . . The telephone system should be universal, interdependent and intercommunicating, affording opportunity for any subscriber of any exchange to communicate with any other subscriber of any other exchange . . . annihilating time or distance by use of electrical transmission.<sup>126</sup>

Nor, given the environment, is it surprising that Congress incorporated this goal in the Communications Act of 1934, which states:

[I]t [is] to make available, so far as possible, to all the people of the United States, a rapid, efficient, nation-wide and world-wide wire and radio communications service with adequate facilities at reasonable charges . . .<sup>127</sup>

It should be noted, moreover, that this goal takes on special significance because it represents the only major change from past policy that the Communications Act brought about. As Richard Victor has pointed out:

The most significant change in the Communications Act may have been its statement of purpose. If Congress meant what it said, then national policy was redirected towards a single, great social objective.<sup>128</sup>

This general mandate reappeared more concretely in a 1949 law that directed the Rural Electrification Administration (REA) to promote telephone service<sup>129</sup>

### Implementing the Goal of Universal Service and Equitable Access

Prior to the telephone's development, the government had relied heavily on Federal subsidies to

<sup>124</sup>For instance, citizen groups working for urban change tried to forge alliances with city newspapers in the 1890s. Where groups were able to get their messages into a city's papers, reforms resulted; where papers closed their columns to reformers, change was stalled. For a brief period at the beginning of the 20th century, social crusaders enjoyed remarkable success in working with reform-minded reporters—the muckrakers. On the importance that social theorists of the Progressive Movement attached to communication, see Jean B. Quandt, *From the Small Town to the Great Community: The Social Thought of Regressive Intellectuals* (New Brunswick, NJ: Rutgers University Press, 1970). On the importance of communication to reform movements, see Richard B. Kielbowicz and Clifford Scherer, "The Role of the Press in the Dynamics of Social Movements," *Research in Social Movements, Conflicts and Change: A Research Annual* (Greenwich, CT: JAI Press, 1986), and David P. Nerd, *Newspapers and New Politics: Midwestern Municipal Reform, 1890-1900* (Ann Arbor, MI: UMP Research Press, 1981). One of the better accounts of muckraking and its relationship to early 20th-century reform is Louis Fuller, *Appointment at Armageddon: Muckraking and Progressivism in American Life* (Westport, CT: Greenwood Press, 1976).

<sup>125</sup>At least for the first several decades of telephony, businesses headquartered in the northeastern corridor stood to make the best use of the new technology. Although patented in 1876, it took 12 years for the lines to reach Chicago, and transcontinental service was not inaugurated until 1915. The telegraph, in contrast, had linked both coasts in a mere 17 years. Of course many communities outside the northeast developed their own local and regional systems, but for the most part they were not effectively integrated into the network. The pattern for establishing telephone links, in fact, largely followed the deployment of postal and telegraphic services: first major trunks linking northeastern cities, followed by lines to smaller towns in their immediate hinterlands, then connections to major Midwestern cities, and so forth—a sequence of connecting ever lower-order cities. For discussions, see Kenneth J. Lipartito, "The Telephone in the South: A Comparative Analysis, 1877- 1920," Ph.D. diss., Johns Hopkins University, 1986; and John V. Langdale, "The Growth of Long-Distance Telephony in the Bell System, 1875 -1907," *Journal of Historical Geography*, vol. 4, No. 2, pp. 145-159.

<sup>126</sup>As cited in Victor, op. cit., footnote 93, p. 3.

<sup>127</sup>As Victor has pointed out, a number of States had already adopted subsidies encouraging residential service. As he notes: "During the 1920s, public utility commissions throughout the country adopted value-of-service pricing and statewide average rate-making. Under the value-of-service concept, business users paid more than residential customers, since the benefit of service to them was greater. Likewise, rates were higher in large exchanges (despite lower costs) than in small ones, since service (the number of possible connections) was superior. Similarly, statewide averaging of rates (for like-sized exchanges and toll calls of equal distance) appealed to public utility commissions on several counts: it encouraged new residential service through cross-subsidization, simplified administrative procedure, and gave the impression of fairness. *Ibid.*, pp. 10-11.

<sup>128</sup>*Ibid.*, p. 17.

<sup>129</sup>For a discussion, see Don F. Hadwiger and Clay Cochran, "Rural Telephones in the United States," *Agricultural History*, vol. 58, July 1984, pp. 221-238.

promote the goal of universal service. In accordance with the regulatory framework established by the Communications Act, however, major responsibility for the task of implementing universal telephone service was shifted to AT&T, although the FCC and the State regulatory commissions were charged with assuring that overall costs were equal to overall prices, and that rates and profit levels were kept within a reasonable range.

To encourage the development of universal service, AT&T needed to develop a subsidy system of its own. Left to the determination of the marketplace, telephones were deployed quite slowly and in a very uneven fashion. In 1921, only 35.3 percent of American households had telephones. This figure climbed to 41.6 percent in 1929, dropped to a Depression-era low of 31.1 percent in 1933, and rebounded slightly to 39.3 percent in 1941.<sup>130</sup> Costs of terminal equipment deterred some households from purchasing telephones, and fees proved too steep where expensive lines had to be strung in sparsely settled areas.

To subsidize the expansion of telephone services, AT&T adopted a pricing structure that was based not on cost of usage, but rather on value of use.<sup>131</sup> Such a system assured that toll users (disproportionately represented by business users) would pay some proportion of the nontraffic-sensitive costs of the local exchange. Because the formula for establishing the amount and distribution of these costs was to a large extent arbitrary, the tendency over time was to shift more and more of the costs of service from local exchange users to toll users. To an ever increasing extent, this formula fostered the development of

residential service at the expense of long-distance users.<sup>132</sup>

In the early years of the telephone company, State regulators adopted what was called a "board-to-board" approach to allocating costs between local exchange and interexchange services—that is, between State and Federal jurisdictions.<sup>133</sup> According to this formula, the entire cost of the local exchange was recovered from local rates, while interexchange costs equaled the cost of toll interconnection from one switchboard to another.

A new formula was adopted in 1930, after the Supreme Court ruled, in the case of *Smith v. Illinois Bell*, that toll users should pay some proportion of the local exchange's fixed costs. The Court declined, however, to specify what a fair proportion would be. To determine how to allocate costs based on the Court's prescribed "station-station" formula, the National Association of Regulatory Utility Commissioners (NARUC) established a task force with the aid of AT&T. The separations manual that NARUC subsequently released called for accounting procedures that provided station-to-station separations based on actual usage. Using this formula:

... state by state, non-traffic sensitive plant actually used to make long distance calls would be allocated to the interstate jurisdiction in proportion to interstate, long-distance usage. 134

Pressure from State regulators to revise this formula developed, however, when advances in transmission technology allowed the cost of long-distance service to decline more rapidly than that of local service. To adjust for this situation, NARUC sought to add a "subscriber plant factor" to the

<sup>130</sup>Richard A. Schwarzlose, "Technology and the individual: The impact of Innovation on Communication," Catherine L. Covet and John D. Stevens (eds.), *Mass Media Between the Wars* (Syracuse, NY: Syracuse University Press, 1984), p. 96.

<sup>131</sup>To establish just and reasonable rates in accordance with the Communications Act of 1934, some formula had to be worked out to allocate costs and to separate the rate base (including the fixed, nontraffic-sensitive plant) between Federal and State jurisdictions. However, as Anthony Oettinger has pointed out, since any formula is to some extent arbitrary and will have a different effect on stakeholders, the decision about what pricing and cost strategy to adopt will depend to a considerable degree on the prevailing public policy goals. For a discussion, see Anthony G. Oettinger, "The Formula Is Everything: Costing and Pricing in the Telecommunications Industry," Program on Information Resources, Center for Information Policy Research, Harvard University, Cambridge, MA, P-88-2, October 1988.

<sup>132</sup>Some have argued that, in the long run, given technological changes and efforts to upgrade the network for the business user, this subsidy has actually worked in reverse. According to Patricia Aufderheide, for example: "Cost shifting is justified on the grounds that the individual user is the 'cost-causer' and that the local loop must now 'pay for itself.' This rationale ignores the changing pattern of technological costs. More elaborate and sophisticated digital switching equipment, making possible services of great immediate value to large users and increasing capacity to carry huge data transmission demands, incurs tremendous investment costs while lowering the cost of switching and transmission. Technological innovation challenges the traditional (though traditionally arbitrary) distinction between non-traffic-sensitive (NTS) and traffic sensitive (TS) costs and poses challenges of separating costs of rate-based and nonrate-based services. Certainly the residential and small-business user has not caused these problems. The need for reassessment of cost allocation is being interpreted as a problem requiring cost shifting to 'end users.'" Patricia Aufderheide, "Universal Service: Telephone Policy in the Public Interest," *Journal of Communication*, vol. 37, No. 1, Winter 1987, p. 83.

<sup>133</sup>For a discussion, see Victor, *Op. cit.*, footnote 93, pp. 20-30. See also Oettinger, *op. cit.*, footnote 131.

<sup>134</sup>Victor, *op. cit.*, footnote 93, p. 22.



measure of relative usage, the effect of which would have been to transfer approximately **\$200** million from the State to the interstate jurisdiction.<sup>135</sup> At first, the FCC refused to approve this change. Later, under pressure from Ernest McFarland, Chairman of the Communications Subcommittee of the Senate Commerce Committee, it agreed to a compromise that went a long way toward accepting NARUC'S original position.<sup>136</sup> By continuing to adjust the cost allocation formula in favor of the local exchange, the FCC and AT&T created a situation over the years whereby the costs and prices of telecommunication services were increasingly dissociated from one another. Contributing to this situation, the FCC, in 1941, adopted a policy of "equal charges for equal service," which was designed to eliminate interstate rate differentials.<sup>137</sup>

These subsidies served well as means of fostering the development of universal telephone service. By 1952, AT&T operated almost entirely under a nationwide average pricing system.<sup>138</sup> Moreover, by 1950, the prospect of attaining the goal of universal service was well in sight, with 80 percent of American homes equipped with telephones.

However, for political as well as economic reasons, a system of subsidies such as this could only be sustained given the conditions of a regulated monopoly. As Gerald Faulhaber has described the unique relationship existing between the Bell System and its regulators:

By announcing a common goal, universal service, Bell gave the regulator the political justification to brush aside potential competitors, barring their entry into the regulatory game. Only two players were involved: Bell and the regulators. They often scrapped over who would get how much, but they seldom argued over who was to sit at the table. Over the years, Bell's regulatory compact with the commissions was broadened to include key parties: rate averaging greatly benefited rural and small-town customers at small cost to urban customers; separations benefited local residential users at the expense of toll and business users; settlements benefited the

independents in return for political support for the system as a whole. Just as Bell sought to deny others access to its markets, it sought to deny access to the regulatory game. In fact, the nature of regulation demanded that it do so to maintain its monopoly market position.<sup>139</sup>

The system was also increasingly untenable from an economic point of view. As new competitors entered the telecommunication market, they were able to price their products much closer to real costs, and hence to undercut AT&T. AT&T's strong reaction to even minor threats of competition make it clear that AT&T was well aware of its inherent vulnerability in this regard.

### **Tensions in Achieving the Goal of Universal Service**

In the minds of some, the goal of achieving universal service has, by and large, already been achieved.<sup>140</sup> And, in fact, it was precisely because this goal seemed to have lost much of its urgency that many began to question the old regulatory arrangements.<sup>141</sup>

Assuming that the goal of universal service has essentially been accomplished, the role of government would appear to be greatly simplified. Under such circumstances, for example, all that needs to be done is to assure that everyone can continue to afford "plain old telephone service." And this objective can best be achieved, according to many of those who adhere to this view, either by providing direct subsidies to the poor—as in the case of lifeline service—or by adopting special pricing schemes such as social contracts that cap, or limit, price increases for basic services. Moreover, each of these approaches is basically compatible with a deregulated, competitive, telecommunication environment.

Others, however, question the basic premise that universal service has already been achieved. Emphasizing the relative nature of the concept, they view the basic task for government as one of redefining the notion of universal service to take into account

<sup>135</sup>*Ibid.*, p. 23.

<sup>136</sup>*Ibid.*

<sup>137</sup>*Ibid.*, p. 25.

<sup>138</sup>*Ibid.*

<sup>139</sup>Gerald R. Faulhaber, *Telecommunications in Turmoil: Technology and Public Policy* (Cambridge, MA: Ballinger Publishing Co., 1987), P. 46.

<sup>140</sup>As of July 1989, 93.3 percent of Americans had access to a telephone in their homes. Universal penetration statistics are compiled periodically in "Telephone SubscriberShip in the United States," Industry Analysis Division, Common Carrier Bureau, FCC.

<sup>141</sup>Faulhaber, *op. cit.*, footnote 139, ch. 3.

the greatly enhanced role of information in society.<sup>142</sup> However, if this latter perspective were eventually to prevail, new kinds of pricing mechanisms and subsidy schemes would need to be developed, since those presently under discussion—such as incentive-based pricing, for example—would most likely be unworkable, given an expanded definition of essential services.

### ***Communication in Support of National Defense and National Security***

In most countries, national systems of communication were developed only after the authority of the State had been firmly established. Under such circumstances, it was quite natural for communication systems to serve, first and foremost, as appendages of government. The goal of establishing a communication system in support of national defense and national security was much less problematic than in the United States where first amendment concerns called for maintaining a wide breach between government and the communication system. Today, the difficulties entailed in providing integrated communication in support of national defense and national security are even greater, given the enhanced role of communication in defense, together with an increasingly deregulated, competitive, communication environment.

### **Establishing the Goal of Communication in Support of Defense and National Security**

In the United States, given the value placed on first amendment goals, the government's involvement in promoting communication for defense and national security has historically been much more sporadic and indirect than in other countries. Perceived threats to the Nation's survival in the 20th

century have led to a greater emphasis on the goal of national security, an emphasis that has at times collided with the goals of free speech, the free flow of information, and the ideal of a free market.

The exigencies of war have often given rise to a short-lived reordering of national values. In autumn 1918, for example, Congress directed the Postmaster General to take over operation of the Nation's telephone and telegraph companies. The traditional preference for private enterprise in communication gave way to concerns about the importance of the wires for national security. Those who had long sought to convert the U.S. Post Office Department into an agency along the lines of the postal, telegraph, and telephone ministries common in Europe seized the opportunity created by exaggerated fears of domestic subversion. Under the post office's management, the telegraph and telephone systems worked smoothly, although rates increased. Shortly after government took control, however, the war ended and Congress restored the wires to their companies. As Wayne Fuller has described:

The Post Office once more assumed its traditional nineteenth-century role: a supporter of free enterprise but never a competitor.<sup>143</sup>

Clearly recognizing the defense potential of radio, the government also played a critical role in its development.<sup>144</sup> The U.S. Navy, in Cooperation with AT&T, helped to develop the emerging technology, and it spearheaded the corporate-government alliance that consolidated and centralized radio during and after World War I.<sup>145</sup>

World War I spurred intensive wireless research. Armed forces all over the world demanded radio units for airplanes, ships, and infantry. After America entered the war in April 1917, the government

<sup>142</sup>For this point of view, see, for instance, U.S. Department of Commerce, National Telecommunications and Information Administration, *NTIA Telecom 2000: Charting the Course for a New Century*, NTIA Special Publication 88-21 (Washington, DC: U.S. Government Printing Office, October 1988).

<sup>143</sup>Wayne Fuller, *The American Mail* (Chicago, IL: Chicago University Press, 1972), pp. 187-188. Proponents and opponents of public ownership of the means of communication pointed to this short-lived experiment as evidence supporting their positions. See also Lindsay Rogers, *The Postal Power of Congress: A Study in Constitutional Expansion* (Baltimore, MD: John Hopkins University Press, 1916), pp. 156-157.

<sup>144</sup>Amateur wireless operators, by interfering with naval and commercial service, made government regulation imperative. The report of the so-called Roosevelt Board in 1904 recommended a three-way division of authority over the American wireless. The Department of Labor and Commerce would supervise commercial stations, the War Department of Labor and Commerce would supervise commercial stations, the War Department would have charge of military stations, and, most importantly, the Navy would control coastal stations. This report, while not law, established the dominance of the U.S. Navy in the American wireless field, enabling it to build its own system and pour millions of dollars into research. Not until the Radio Act of 1912 did government produce a comprehensive plan with the goal of regulating wireless. *Czitrom*. op. cit., footnote 27, p. 23.

<sup>145</sup>The perfection of wireless telephony—the transmission of speech without wires—grew largely out of research and development by several large corporations and the Federal Government. AT&T, wary of possible competitive threats from wireless telephony, launched a massive research and patent purchasing effort, acquiring all rights covering the use of vacuum tubes in wire and wireless telephony. AT&T and the U.S. Navy cooperated in 1915 in the first successful tests of transcontinental wire telephony and transoceanic radio telephony. General Electric also entered the field in these years, focusing on the construction of high-frequency transmitters for long-distance wireless and on the perfection of vacuum tubes. *Ibid.*, p. 24.

took over all wireless stations, and, more importantly for future events, guaranteed manufacturers protection against legal action over patent infringements. This action permitted a vast coordinated effort in the manufacture of radio parts and stimulated a boom in radio research.<sup>146</sup>

The Federal Government also took a strong interest in radio's postwar future. The Wilson Administration's goal was to challenge British domination of international communication and to protect U.S. military and commercial interests. After failing to get Congress to pass legislation that would make wartime government control of wireless stations permanent, the administration pursued a different strategy. In 1919, British Marconi was the only company negotiating with General Electric (GE) to buy exclusive rights to the Alexanderson Alternator, a high-powered radio transmitter used for transoceanic work during the war. Through a series of long and delicate negotiations, the government stepped in and served as the midwife to the birth of the Radio Corp. of America (RCA). RCA, with GE as the major stockholder, bought out American Marconi (which had been controlled by the British), thus assuring America a powerful position in world communication.<sup>147</sup>

The military's role in the development of the computer was also critical, even if indirect and behind the scenes. As Kenneth Flamm notes:

It was no accident that the military services largely financed the postwar development of the computer in the 1950s, for computing technology had played a pivotal role in the Allied war effort. The military indirectly bankrolled even the Eckert and Mauchly computer projects, and these relatively open projects were only the tip of a much larger, and sometimes hidden, technological iceberg.<sup>148</sup>

The role of the Navy was particularly important. Its interest in computing and advanced communication technologies went back as far as World War I when technological advances in naval warfare cre-

ated a whole range of new technical problems for military strategists.<sup>149</sup> As Flamm points Out:

By the end of 1948, the ONR (Office of Naval Research) employed one thousand in-house scientists, funded about 40 percent of basic research in the United States, and was working on research contracts amounting to \$43 million (\$20 million of its own money, \$9 million from other federal agencies, and \$14 million of university money.)<sup>150</sup>

Defense support for the computer industry was also directed through the National Bureau of Standards (NBS) which, as in the case of other government agencies, was redirected towards military objectives during World War II. Although NBS played a significant role in the development of the computer, its funding was drastically cut in 1954. Not surprisingly, this timing coincided with the emergence of a burgeoning commercial computer industry. Much in keeping with the U.S. Government's historical approach to dealing with the communication industry in times of peace, Secretary of Commerce Weeks justified these budget cutbacks on the grounds that "the National Bureau of Standards has not been sufficiently objective because they discount entirely the play of the marketplace"<sup>151</sup>

Issues involving limits on expression for national security reasons have also become exacerbated during times of war. They first arose when opponents to World War I, in particular socialists and German immigrants, risked prosecution under State or Federal sedition laws. The laws were premised on the notion that speech could undermine the war effort and hence endanger the Nation's security. A number of cases wound their way to the Supreme Court and convictions were common because the Court often applied a "reasonable tendency" test. Using this standard, expression opposing the war was found punishable merely for having a tendency to produce behavior that Congress or a State legislature proscribed. At the same time, however, some justices began fashioning a standard that was more protective of free speech rights, the "clear and

<sup>146</sup> J. Douglas, *Inventing American Broadcasting, 1899-1922* (Baltimore, MD: The Johns Hopkins University Press, 1987), chs. 7 and 8.

<sup>147</sup> See Daniel J. Czitrom, *Media and the American Mind: From Morse to McLuhan* (Chapel Hill, NC: University of North Carolina Press, 1982), p. 70. See also Hugh G.J. Aitken, *The Continuous Wave: Technology and American Radio, 1900-1932* (Princeton, NJ: Princeton University Press, 1985).

<sup>148</sup> Kenneth Flamm, *Creating the Computer: Government, Industry and High Technology* (Washington, DC: The Brookings Institution, 1988), ch. 3. Quote at p. 29.

<sup>149</sup> *Ibid.*, p. 34.

<sup>150</sup> *Ibid.*, pp. 42-43.

<sup>151</sup> As cited in *ibid.*, p. 73.

present danger” test. This test, which would only cut off speech that was highly likely to pose an imminent and substantial danger to some vital interest, proved more influential in the long run.<sup>152</sup>

On rare occasions during peacetime the government has sought to enjoin the press from publishing information whose disclosure was seen by some to undermine national security. The government’s attempt to invoke national security to stop publication of the Pentagon Papers failed when the Supreme Court, acknowledging that national security was sufficient reason to impose a prior restraint on publication, ruled that in this instance the government had failed to show that anything more than embarrassment would result. In effect, the door was left ajar. Where atomic secrets have been involved, the government has been better positioned to justify a prior restraint. In 1979, for example, the government obtained a district court injunction that stopped publication of an article by *The Progressive* magazine that depicted the making of a hydrogen bomb.<sup>153</sup>

### Implementing the Goal of Providing Communication in Support of National Defense and National Security

The government’s ability to balance first amendment and free market goals against national security goals was greatly aided by the existence of a government-regulated telephone monopoly, which was renowned for the quality and extent of its research in all communication-related fields. The importance of the Department of Defense’s (DoD’s) dependence on AT&T stems from the fact that national policy has required the Federal Government to procure all of its telecommunication services, including those for national defense, from the commercial sector, unless special circumstances dictated otherwise. Thus, 85 percent of Federal Government and 94 percent of critical U.S. national security needs within the continental United States (CONUS) are reported to be leased from the commercial telecommunication carriers. In total, the

Defense Communications Agency (DCA) leased approximately \$530 million in long-haul domestic telecommunications in 1981.<sup>154</sup>

As the only company effectively supplying end-to-end telecommunication services to DCA, AT&T has historically been closely and directly involved in the formulation of national security telecommunication specifications and requirements; telecommunication research and development; the planning, routing, and installation of networks; and in making adequate provisions governing robustness, ubiquity, and restorability. With AT&T having a monopoly, it could guarantee end-to-end connectivity. In addition, the sheer size of AT&T, and the extent of its network, meant that it was able to meet the more demanding requirements of the U.S. Armed Services. The relationship that thus developed between AT&T and DoD was strictly one-to-one. Thus, infrequently, AT&T would install a telecommunication line or circuit for DCA, reroute or harden a cable to enhance survivability, or retain redundant lines without managing a direct charge to the defense budget; the cost would be defrayed by being absorbed in the overall rate base to AT&T subscribers.

The operational advantages to DCA of having a single, central communication system were summed up by William Taft IV, General Counsel to DoD, when testifying about the prospect of divestiture before a Senate Judiciary Committee on August 6, 1981. As he said:

The central system has incentives to respond and plan in a coordinated manner that a fragmented system would not . . . divestiture could cause substantial harm to our national defense and security and emergency preparedness capabilities . . . the telecommunications network cannot properly be artificially divided between inter-city and local exchange functions.<sup>155</sup>

Surprisingly, little attention was given to the national security aspects of the AT&T divestiture during the 1974 antitrust suit. The Department of

<sup>152</sup>For a discussion, see Zechariah Chafee, Jr., *Free Speech in the United States* (Cambridge, MA: Harvard University Press, 1941); and Paul L. Murphy, *The Meaning of Freedom of Speech: First Amendment Freedoms from Wilson to FDR* (Westport, CT: Greenwood Press, 1972).

<sup>153</sup>A circuit court eventually dismissed the case as moot, but many observers thought that government could have satisfied a court that “grave and irreparable damage” to the Nation would have resulted from publication. See *New York Times v. United States* 403 U.S. 713, 1971 (Pentagon Papers case); see also A. De Volpi et al., *Born Secret: The H-Bomb, the “Progressive” Case and National Security* (New York, NY: Pergamon Press, 1981).

<sup>154</sup>Martin Edmonds, “Defense Interests and United States Policy for Telecommunication \,” OTA contractor report, June 30, 1988, p. 19.

<sup>155</sup>U.S. Senate, Committee on the Judiciary, hearings on DoD Oversight: U.S. v. AT&T 97th Cong., Aug. 6, 1981. p. 42.

<sup>156</sup>*Ibid.*

Justice's (DOJ's) case was based almost exclusively on AT&T's past anticompetitive behavior, with supporting evidence being sought only from telecommunication and data-processing companies such as IBM and MCI—all eager to see AT&T's domination of the domestic market reduced or terminated. However, it was not as though DOJ was unaware of DoD's position. In March 1981, at an early stage in the AT&T antitrust case, Secretary of Defense Weinberger wrote to Attorney General William French Smith urging that the suit against AT&T be dropped on national security grounds. At the least, according to Weinberger, DOJ should:

... not require or accept any divestiture that would have the effect of interfering with or disrupting any part of the existing communication facilities or network of the AT&T Company that are essential to defense command and control.<sup>157</sup>

Notwithstanding these concerns, the divestiture of AT&T basically followed DOJ's vision, giving antitrust concerns priority over national security goals. Moreover, this set of priorities was established at the very same time that the Administration was revising strategic policy, shifting its focus from one of deterrence to one that placed the very highest importance on military Command, Control and Communications and Intelligence (C<sup>3</sup>I) invulnerability, with respect to both strategic policy and national security emergency preparedness.

Failing to prevent divestiture, DoD responded in a pragmatic way by seeking waivers from the regulatory agencies and structural modifications to the terms of divestiture to ensure the integrity of the

public switched network on which it had relied so heavily. To make certain that the President had the necessary telecommunication capability to fulfill his statutory obligations in times of war or emergency, an all-industry advisory committee, the National Security Telecommunications Advisory Committee (NSTAC) was established by Executive order, to be supported by the National Communication System. Comprising 27 of the chief executive officers of the telecommunication and data-processing industries, and reporting directly to the President, NSTAC is in a unique position to find consensus not merely on national security issues, but on the health and direction of the communication industry as a whole.

### **Present Tensions With Respect to Defense-Related Communication Goals**

How long the present arrangements involving NSTAC, and the partnership between government and industry, can continue is uncertain. So, too, in the longer term, is the effect of national security considerations on the commercial U.S. telecommunication scene. There are legal implications if the current arrangements are taken further, and there is a limit to how far the umbrella of national security interests can be extended. The implications are therefore clear: in the absence of any explicit guidance on telecommunication priorities for the United States (other than the further encouragement of open competition), and given the polycentric nature of telecommunication policymaking and the uncertainty that still surrounds the industry, some central policy initiative will be needed in the future.

---

<sup>157</sup>G. Bolling, *AT&T: Aftermath of Anti-Trust* (Washington, DC: National Defense University, 1984), p. 51; and *Coll, op. cit.*, footnote 96, p. 187.

**Part II**

**Opportunities and Constraints  
Provided by New Communication  
Technologies in the Business Arena**

## **Chapter 5**

# **Communication and Comparative Advantage in the Business Arena**

# CONTENTS

	<b>Page</b>
INTRODUCTION ... .. = . . . . .	107
THE ECONOMIC REALM . . . . .	108
COMMUNICATION TECHNOLOGIES AND ECONOMIC ACTIVITIES . . . . .	108
Socioeconomic Context: Enhanced Economic Stakes Communication and Information-Related Activities . . . . .	112
Key Business Activities . . . . .	116
Framework for Thinking About the Business Opportunities Presented by New Communication Technologies . . . . .	116
ANALYSIS OF BUSINESS ACTIVITIES..... . . . . = . . . . .	117
Operations . . . . . + . . . . .	117
Service . . . . . 4. . . . .	120
Technology Development . . . . .	120
Human Resource Management . . . . .	121
Firm Infrastructure . . . . .	122
Inbound Logistics . . . . .	123
Outbound Logistics . . . . .	123
Procurement . . . . .	124
Marketing and Sales . . . . .	124
IMPACTS ON ECONOMIC PLAYERS . . . . .	126
Players and Role Relationships introduction Activities . . . . .	126
Potential Impacts of New Business Opportunities on Players in the Production Process . . . . .	129
Roles and Relationships in Market Activities . . . . .	132
KEY FACTORS AFFECTING OUTCOMES . . . . .	135
Compatibility and Interconnectivity of Information Systems -... . . . .	136
Legal Framework for Employing Information in the Business Environment . . . . .	137
Economic and Technical Resources . . . . .	137
Corporate Culture and Organizational Structure . . . . .	138
International Trade and Foreign Communication Policies . . . . .	140
Domestic Communication Regulatory Policies . . . . .	141
Human Resources . . . . .	141

## Box

<i>Box</i>	<i>Page</i>
5-A. Selected Innovations in Information processing and Communication. 1830-87 . . .	110

## Figures

<i>Figure</i>	<i>Page</i>
5-1. Structural Change and the Information Economy . . . . .	113
5-2. Impact/Value Framework . . . . .	118
5-3. The Cast of Players. . . . .	127
5-4. Spending for Communications by Large Users. 1983-1993 Comparison .. . . .	138

## Tables

<i>Table</i>	<i>Page</i>
5-1. Key Business Activities . . . . .	117
5-2. The Internal Influencers and Their Play of Power . . . . .	128
5-3. Main Obstacles to Effective and Strategic Use of Internetworking . . . . .	136
5-4. Top 50 U.S. Communication Users . . . . .	139



# Communication and Comparative Advantage in the Business Arena

## INTRODUCTION

The U.S. economy has fared reasonably well over the past few years. However, many observers are beginning to have serious reservations about the future of the U.S. economy and its ability to compete in an increasingly global environment.<sup>1</sup> They point out that economic growth in the United States has been fueled by borrowing foreign capital. Export growth in the manufacturing sector has been increasing at a much slower rate than import growth, which, rising precipitously, reached about \$160 billion in 1986. Experts note, moreover, that the continued decline of the U.S. economic position in world trade is likely to have serious consequences for labor. Between 1980 and 1984 alone, the number of jobs generated by exports fell from over 6 million to 4.5 million.<sup>2</sup> Pointing to the apparent success of the Japanese model of business organization, some have even suggested that the United States may also need to develop and adopt new ways of organizing for production if it is to be competitive.<sup>3</sup>

Many of those who are concerned about the U.S. economy look towards the communication and information sectors to provide the impetus for future growth.<sup>4</sup> This focus on "telematics" is not surprising, given the trend toward a greater role for information in advanced industrial societies, and the fact that the United States has traditionally had a

comparative advantage in this area. Communication is regarded, moreover, not only as a source of economic growth, but also as a means of reconfiguring work relationships to make them more effective.<sup>5</sup>

Just as the growth and development of the communication sector is considered to be critical to the well-being of the economy as a whole, so too is it considered a strategic factor in competition among firms. Increasingly, companies need to take communication into account in developing their overall business strategies. As Clemens and McFarlan have pointed out:

The new technologies of communication have the power to change the competitive game for almost all companies of all sizes.<sup>6</sup>

Given the linkages between communication regimes and economic activity, the way in which the U.S. communication infrastructure evolves over the next several years is likely to have significant impacts on the business world and the economy as a whole. To determine these impacts, and to suggest possible policy choices about them, this chapter will examine the nature of the opportunities and constraints presented by new communication technologies in the economic realm. To this end, it will:

. characterize the economic realm,

<sup>1</sup>For a discussion, see Robert Z. Lawrence, *Can America Compete?* (Washington, DC: The Brookings Institution, 1984); President's Commission on Industrial Competitiveness, *Global Competition: The New Reality* (Washington, DC: U.S. Government Printing Office, 1985); George Cabot Lodge and William C. Crum, "U.S. Competitiveness: The Policy Triangle," *Harvard Business Review*, vol. 63, January-February 1985, pp. 34-36, 38-39, 41, 42, 46, 48, 50, and 52; and Peter G. Peterson, "The Morning After," *Atlantic Monthly*, vol. 260, October 1987, pp. 43-50, 52-55.

<sup>2</sup>OTA staff, personal communication, Mar. 14, 1989. The labor content of exports also fell from 30,300 jobs per \$1 billion of exports to less than 25,000.

<sup>3</sup>For three very different discussions, see Bob Reich, *Tales of a New America* (New York, NY: Time Books, 1987), especially ch. 10; David H. Bernadin and Michael A. Harrison, *The Technology War: A Case for Competitiveness* (New York, NY: John Wiley & Sons, 1987); and Michael J. Piore and Charles F. Sabel, *The Second Industrial Divide* (New York, NY: Basic Books, Inc., 1984).

<sup>4</sup>See, for example, Charles Jonscher, "Information Resources and Economic Productivity," *Information Economics and Policy* (North Holland: Elsevier Science Publishers, 1983), pp. 13-35. Note that telecommunication industry shipments are expected to grow to an annual rate of 9 percent, in real (deflated) terms, for the next 5 years. International Trade Administration, U.S. Department of Commerce, *1987 U.S. Industrial Outlook for Over 350 Industries* (Washington, DC: U.S. Government Printing Office, January 1987), pp. 30-37.

<sup>5</sup>For example, see Shoshana Zuboff, *In The Age of the Smart Machine: The Future of Work and Power* (New York, NY: Basic Books, 1988); see also Ranchadran Jaikumar, "Postindustrial Manufacturing," *Harvard Business Review*, November-December 1986, pp. 69-76.

<sup>6</sup>Eric K. Clemens and F. Warren McFarlan, "Telecom: Hook Up or Lose Out," *Harvard Business Review*, July-August, 1986, pp. 91-97; see also Peter G. W. Keen, *Competing in Time Using Telecommunications for Competitive Advantage* (Cambridge, MA: Ballinger Publishing Co., 1986); Donald A. Marchand and Forest W. Horton, Jr., *Infotrends: Profiting From Your Information Resources* (New York, NY: John Wiley and Sons, 1986); and James I. Cash, Jr., F. Warren McFarlan, and James L. McKenney, *Corporate Information Systems Management: The Issues Facing Senior Executives* (Homewood, IL: Irwin, 1988).

- describe how communication technologies have affected economic activity in the past, and
- provide a framework for analyzing economic impacts in the future.

This framework will be used to analyze the potential uses and impacts of communication technologies in several key business activities, and to identify the major factors and related policy issues that will determine the impact of communication technologies in the economic realm.

## THE ECONOMIC REALM

The economic realm is that sector of human activity in which the production and exchange of goods and services takes place. In modern capitalistic societies, it is the market system that serves, for the most part, to manage the processes of economic activity, coordinating supply and demand and allocating goods and services. To the extent that the structure of the market replicates a state of perfect competition, that each producer selects the combination of factors of production that will maximize profits, and that each consumer seeks to maximize preferences, the price system can be assumed to distribute goods and services in the most efficient fashion.<sup>7</sup>

In the economic realm, behavior is considered to be governed by self-interest. Hence, self-interest is the criterion that is most likely to be used in evaluating economic outcomes.<sup>8</sup> Accordingly, producers will seek higher profits; workers better wages and an improved quality of work life; investors higher returns on their investments; and consumers higher quality products at a lower price.

From a more general perspective, the performance criteria of a firm, industry, or national economy are generally those of efficiency and growth.<sup>9</sup> As the

sociologist, Daniel Bell, has noted, the principal value underlying the economic realm is that of “fictional rationality”—that is, each individual and each group in the system carry out rationally conceived, specified roles that, taken together, are designed to maximize production. The principal means of achieving this value is by economizing; decisions are made on the basis of cost/benefit analyses, and technology is applied to substitute more efficient processes for less efficient ones.<sup>10</sup>

Communication is inherent in the coordination required for all economic activity. The exchange of information, for example, is at the heart of the market system.<sup>11</sup> Capitalism depends on the communication of information to efficiently allocate resources. Within firms, the delivery of timely and accurate information is key to decisions about whether to enter or exit markets, how to secure financing, how to organize and manage workers effectively, and how to distribute and market goods. Firms without access to such data, and the communication networks required for their use, will be at a severe disadvantage when competing with other firms that have such access.

## COMMUNICATION TECHNOLOGIES AND ECONOMIC ACTIVITIES

Given the link between communication and economic activity, it is not surprising that communication technologies have historically played an important role in economic development and growth. At one time, market relationships consisted almost entirely of face-to-face exchanges. Today, mediated communication has replaced most of this primary contact. Now, an exchange of information often precedes or inheres in an economic transac-

<sup>7</sup>For a discussion of the resumptums and values underlying the economic realm, see Duncan MacRae, Jr., *The Social Function of Social Science* (New Haven, CT and London: Yale University Press, 1976), p. 160. See especially chs. 5 and 6. See also Robert Heilbroner, *The Nature and Logic of Capitalism* (New York, NY: W.W. Norton and Co., 1985).

<sup>8</sup>*Ibid.* It should be noted that self-interest is assumed to be a driving motivation only insofar as individuals are operating in economic roles. In real life individuals play many, and often conflicting, roles. Hence, in other contexts individuals' motivations and values might be quite different.

<sup>9</sup>Economic growth was the main concern of classical economists. By economic growth we mean the process by which real national income increases over a very long time period. For a discussion, see Gerald M. Meier and Robert E. Baldwin, *Economic Development: Theory, History, Policy* (New York, NY: John Wiley & Sons, Inc., 1961). It should be noted, however, that the focus on growth may exhibit historical and cultural biases. For a comparison of U.S. and Japanese perspectives on economic growth, see James Fallows, *More Like Us: Making America Great Again* (Boston, MA: Houghton Mifflin Co., 1989).

<sup>10</sup>Daniel Bell, *The Cultural Contradictions of Capitalism* (New York, NY: Basic Books, 1976), pp. 10-11.

<sup>11</sup>For an in-depth discussion of the role of communication in the market system, see James R. Beniger, *The Control Revolution: Technology and the Economic Origins of the Information Society* (Cambridge, MA: Harvard University Press, 1986). As Steiner has pointed out, fundamentally a market can be defined as the “entire web of relationships between buyers, sellers, and products that is revolved in an exchange.” Peter Steiner, “Markets and Industries,” *International Encyclopedia of Social Science* (New York, NY: Macmillan), vol 9, pp. 575-581.

tion. Advertising, for instance, alerts consumers to the availability and characteristics of products and services, and information alone virtually drives securities and commodity markets.<sup>12</sup>

The deployment of communication technologies has increased economic activity and fostered economic growth in a number of interrelated ways. First, communication technologies have dramatically increased both the speed and the number of economic transactions that can take place. Second, by diminishing the relevance of geographic distance, communication technologies have facilitated the expansion of trade and markets. At the same time, the development of mass media technology served to reinforce national markets by helping to mold tastes and preferences into a more uniform cast. In turn, this increase in market size led to greater specialization, standardization, and economies of scale. By enhancing intrafirm coordination, communication technologies allowed businesses to grow vertically and horizontally, and thus to exploit these economies.

The important role that communication and information technologies have played in economic terms can be seen by tracing their development in conjunction with industrial development in the United States. Box 5-A provides a chronological list of these technological developments from 1830 to 1887.<sup>13</sup>

From the 15th century until the development of the railroad and the telegraph in the last half of the 19th century, material goods were transported very slowly—at the speed of draft animals if they traveled by roadway or canal, or “at the whim of the winds” if they traveled by sea.<sup>14</sup> Because transportation and communication over long distances was difficult and slow, trade was discouraged and markets were geographically limited in size. At such distances, merchants did not have a great deal of information

on which to base their sales. Prices differed significantly from market to market, and considerably exceeded the costs associated with distribution. As a result, most merchants refrained from long-distance trading. When they did engage in such trade, they generally remained at home, relying on merchants in other trade centers to sell their goods on a commission basis. To minimize and spread the sizable risks involved, they sold a wide variety of products rather than specializing.<sup>15</sup> Given the 4-month lag in transatlantic communication, as well as European mercantilist policies, it is not surprising that trade between the American colonies and Great Britain was generally limited,

Although the speed of transportation and communication did not greatly increase in post-revolutionary America, the volume of trade did grow as a commercial infrastructure was gradually established and as more effective means of transportation and communication were deployed.<sup>16</sup> Equally important to the development of trade was the establishment of a network of people who, in their various roles as middlemen, helped to convey market information and goods across both the North American continent and the Atlantic Ocean. Included among them were shippers, financiers, jobbers, transporters, insurers, brokers, auctioneers, and retailers.<sup>17</sup>

The impacts of these developments were cumulative. Trade gave rise to more trade. \*8 As markets expanded, so did the density of merchant exchange networks and the amount of available market information. As a result, distribution costs declined, and merchants were further encouraged to engage in trade. Moreover, with larger markets and better information, merchants faced fewer risks, and thus they were able to specialize in particular aspects of trading such as importing, wholesaling, retailing, or exporting. This increased specialization led, in turn,

<sup>12</sup>Richard B. Kielbowicz, “The Role of Communication in Building Communities and Markets: An Historical Overview,” OTA contractor report, November 1987, p. 2.

<sup>13</sup>Beniger, *op. Cit.*, footnote 1”

<sup>14</sup>*Ibid.*, p. 219.

<sup>15</sup>*Ibid.*, p. 174.

<sup>16</sup>The commercial infrastructure was comprised of commercial banks (1780s), a Federal banking system (1791), State insurance regulations (1799), Federal bankruptcy law (1800), and joint stock companies (1810). The new technologies included a Federal postat service (1791), the first turnpike (1795), coastal steamboat travel (1809), mail delivery by steamboat (1813), regular packet service to England (late 1810s), steam railroads and Atlantic clipperships (early 1830s), local postal delivery service (1836), regular transatlantic steamship service (1 847 ), and regular steamboat to California ( 1849). *Ibid.*, p. 130.

<sup>17</sup>*Ibid.*, pp. 155-165.

<sup>18</sup>*Ibid.*, pp. 173-174.

**Box 5-A-Selected Innovations in Information Processing and Communication, 1830-87**

Year	Innovation
1830s	Wagon lines carrying freight between rural towns and ports begin to operate on regular schedules.
1837	Telegraph demonstrated, patented.
1839	Express delivery service between New York and Boston organized using railroad and steamboat.
1840s	Freight forwarders operate large fleets on canals, offer regular through-freight arrangements with other lines.
1842	Railroad (Western) defines organizational structure for control.
1844	Congress appropriates funds for telegraph linking Washington and Baltimore; messages transmitted.
1847	Telegraph used commercially.
1851	Telegraph used by railroad (Erie). First-class mail rates reduced 40-50 percent.
1852	Post Office makes widespread use of postage stamps.
1853	Trunk-line railroad (Erie) institutes a hierarchical system of information gathering, processing, and telegraphic communication to centralize control in the superintendent's office.
1855	Registered mail authorized, system put into operation.
1858	Transatlantic telegraph cable links America and Europe, service terminates after 2 weeks.
1862	Federal Government issues paper money, makes it legal tender.
1863	Free home delivery of mail established in 49 largest cities.
1864	Railroad postal service begins using special mail car. Postal money order system established to insure transfer of funds.
1866	Telegraph service resumes between America and Europe. "Big Three" telegraph companies merge in single nationwide multiunit company (Western Union), first in United States.
1867	Railroad cars standardized. Automatic electric block signal system introduced in railroads.
1874	Interlocking signal and switching machine, controlled from a central location, installed by railroad (New York Central).
1876	Telephone demonstrated, patented.
1878	Commercial telephone switchboards and exchanges established, public directories issued.
1881	Refrigerated railroad car introduced to deliver Chicago-dressed meat to Eastern butchers.
1883	Uniform standard time adopted by United States on initiation of American Railway Association.
1884	Long-distance telephone service begins.
1885	Post Office establishes special delivery service.
1886	Railroad track gauges standardized.
1887	Interstate Commerce Act sets up uniform accounting procedures for railroads, imposes control by Interstate Commerce Commission.

SOURCE: Reprinted by permission of the publishers from *The Control Revolution* by James R. Beniger, Cambridge, MA: Harvard University Press. Copyright 1986 by the President and Fellows of Harvard College. All rights reserved.

to greater coordination of markets and reduced costs, making trade even more attractive.<sup>19</sup>

Also critical to the growth of markets was the development of mass media technologies such as power-driven, multiple rotary printing and the national postal system. By drawing audiences into larger and larger communities, these technologies accelerated the marketing of consumer goods on a national scale. The increasing use of syndicated material in newspapers and the advent of nationally circulated magazines in the late 1800s anticipated true mass communication.<sup>20</sup> Catalogs also became popular as an advertising medium. In 1887, Montgomery Ward distributed nationally a 540-page catalog that offered more than 24,000 items for sale.<sup>21</sup>

Despite the development of national markets and greatly increased trade, specialization and rationalization of production was limited until the late 1800s by the relatively low speed of transportation and communication technologies. As both Alfred Chandler and James Beniger point out, specialization can only take place, and productivity can only be increased, to the extent that goods can be moved, processed, and distributed and that the production process itself can be coordinated.<sup>22</sup> It was only with the development of the railroads in the 1830s and the telegraph in 184 that the requisite speed and control in the processes of production and exchange could be achieved. By increasing the speed of communication and extending the range of possible control, the railroad, the telegraph, and later the telephone facilitated the growth of large-scale organizations with modern management structures, a first step in the centralization of production and distribution.<sup>23</sup>

Given the speed of the new technologies, the growth of the modern corporation was not limited by

national geographic boundaries. Employing communication technologies to coordinate their activities, a number of these new enterprises invested abroad in what proved to be very successful international ventures.

Although communication technologies affected all economic relationships, their impact was not distributed equally nor experienced uniformly. As Joseph Schumpeter has pointed out, technology gives rise to economic growth through the process of “creative destruction.”<sup>24</sup> Thus, although the economy as a whole prospered as a result of communication and information technologies, some segments within society found themselves worse off.

For example, one group whose fortunes changed radically as a result of the vertical integration of many marketing tasks was the numerous middlemen who had performed the function of transmitting and distributing market information and goods. As Beniger notes, the decade of the 1880s:

... saw the wholesalers challenged by new mass retailers—department and chain stores and mail-order houses—that purchased from manufacturers directly and thereby integrated still further the processes of distribution and marketing. Although the total number of wholesalers continued to grow into this century, increasing six- to eightfold between 1880 and 1925, their market share began to decline in the early 1880s. Between 1869 and 1879 the ratio of wholesale to direct sales rose to 2.40 from 2.11, with only \$1 billion worth of goods passing directly from manufacturers to retailers in the latter year, while some \$2.4 billion worth went by way of wholesalers. After 1889, however, when wholesaling’s predominance had already declined slightly to 2.33, the ratio began to fall evermore sharply: to 2.15 in 1899, to 1.90 in 1909, and to 1.16 by 1929.<sup>25</sup>

<sup>19</sup>*Ibid.* The positive effect that increased information exchange had on trade was clearly exhibited, for example, with the development of the transatlantic cable in 1866. Before the completion of the Atlantic telegraph, New York financiers were unwilling to trade in London markets, unless prices were very attractive, because it took 6 weeks to clear prices and have their orders executed there. The completion of the undersea cable radically changed the situation, bringing about an immediate convergence of prices on both sides of the Atlantic. Kenneth D. Garbade and William L. Silber, “Technology, Communication, and the Performance of Financial Markets 1840-1975,” *Journal of Finance*, vol. 33, June 1978, pp. 819-832.

<sup>20</sup>Theodore Peterson, *Magazines in the Twentieth Century* (Urbana, IL: University of Illinois Press, 1964, 2d ed.).

<sup>21</sup>Beniger, op. cit., footnote 11, pp. 18-19.

<sup>22</sup>*Ibid.*, p. 208; and Alfred D. Chandler, Jr., *The Visible Hand: The Managerial Revolution in American Business* (Cambridge, MA: Harvard University Press, 1977).

<sup>23</sup>*Ibid.*, and Beniger, op. cit., footnote 11. Before the development of these technologies, businesses were usually run by their owners who, focusing on a single line of products, generally operated either a single unit of production or a single unit of distribution. There were only a few salaried managers who typically worked directly with the owners. Alfred D. Chandler, Jr., “The Evolution of Modern Global Competition,” Michael E. Porter (ed.), *Competition in Global Industries* (Boston, MA: Harvard Business School Press, 1986), p. 405.

<sup>24</sup>Joseph Schumpeter, *The Theory of Economic Development*, translated by R. Opie (Cambridge, MA: Harvard University Press, 1934).

<sup>25</sup>Beniger, op. cit., footnote 11, p. 258.

The new technologies also favored large firms at the expense of small ones, contributing to the growth of oligopoly. As the scale of operations also grew, size served as a barrier to entry because most small firms lacked the resources needed to function nationally or regionally. With the development of national advertising, the small, local retailers, who had once served their communities with little competition, found themselves facing a succession of challengers—department stores, mail-order firms, and chain stores.<sup>26</sup> Compounding the advantages reaped by large firms was the slow, uneven diffusion of the telephone. Although patented in 1876, it took 12 years for lines to reach Chicago, and another 17 for a transcontinental service to be inaugurated. Thus, businesses headquartered in the northeastern corridor had a considerable advantage in using the new technology.<sup>27</sup>

Just as the telegraph, telephone, and broadcast media have affected economic activities and relationships in the past, so, too, will today's technological advances have a profound effect on the economy of the future. To gain a better understanding of what this impact might be, we need to begin by characterizing the socioeconomic context in which new technologies are emerging.

### ***Socioeconomic Context: Enhanced Economic Stakes in Communication and Information-Related Activities***

The impacts of new communication technologies on economic activity will be due not only to the inherent nature of the technologies themselves, but also to the development of two major and interrelated trends: the trend toward a society that is information- or knowledge-based, and the trend toward a global economy. Driven in part by technological advances, these trends serve to increase the economic stakes in how new communication technologies evolve and are deployed; hence, they may intensify many of the policy issues that relate to their

development. To fully anticipate the impacts of the new technologies, it is necessary to look more closely at these two trends.

### **Trend Toward an Information-or Knowledge-Based Society**

Today, the new information technologies provide numerous ways of enhancing the values of the economic realm. They can improve efficiency and increase productivity, thus engendering economic growth. Information itself is reusable and, unlike capital resources such as steel or iron, its production and distribution require very few physical resources. Not only can information be used to substitute more efficiently for labor; it can also be used to improve the overall efficiency of the productive process itself. And, as productive processes become increasingly complex in advanced industrial societies, the largest reserve of economic opportunities will be in organizing and coordinating productive activity through the process of information-handling.<sup>28</sup> Given these characteristics and capabilities, information is likely to become more important as a resource in the economic realm.

This increasing importance of information to the economy is evident from the continued growth of the information sector of the economy, a trend that has been paralleled in other advanced industrial societies. In fact, it was to highlight this change that terms such as the "information society" and the "information age" were first employed.<sup>29</sup> A recent analysis estimates that the information sector constitutes 34 percent of the gross national product (GNP), and accounts for 41.23 percent of the national labor force.<sup>30</sup>

The changing economic role of information can also be seen by examining how information technologies are being used by business and industry. Businesses are now applying computer technology to almost all of their activities—from recruiting to laying off workers; from ordering raw materials to

<sup>26</sup>Kielbowicz, op. cit., footnote 12.

<sup>27</sup>Ibid.

<sup>28</sup>Jonscher, op. cit., footnote 4, pp. 13-35.

<sup>29</sup>Fritz Machlup was one of the first to note these changes and to measure the information sector in his pioneering work, now a classic, entitled *The Production and Distribution of Knowledge in the United States* (Princeton, NJ: Princeton University Press, 1962). Others have followed this tradition.

<sup>30</sup>Michael Roger Ruben and Mary Taylor Huber, *The Knowledge Industry in the United States: 1960-1980* (Princeton, NJ: Princeton University Press, 1986). This volume updates the work done by Fritz Machlup. In their breakdown of the information sector of the economy, Ruben and Huber note that, leaving education aside, the contribution of knowledge-production to the GNP increased from 17.9 percent in 1967 to 24.5 percent in 1980. The contribution of education, on the other hand, fell from 16.6 percent to 12.0 percent during the same period, a decline that accounts for the fact that the overall contribution of knowledge-production remained relatively stable at about one-third of the GNP.

manufacturing products; from analyzing markets to performing strategic planning; and from inventing new technologies to designing applications for their use. The extent of this deployment can be seen clearly from figure 5-1, which shows the compositional trends in capital spending in terms of the mix of the work force.<sup>31</sup> As the upper half of the figure illustrates:

From the mid-Sixties through last year (1983), high-tech spending as a portion of total business fixed investment almost tripled—rising from about 1290 to roughly a third. Similarly, over the same period, the employment share of information workers is estimated to have risen around 10 percentage points to about 5570 of the nonfarm workforce.<sup>32</sup>

In contrast, from the lower half of the figure one can see that along with the decline in production workers, there was a decline in the basic industrial share of capital spending.

As a portion of total expenditures in plant and equipment, such outlays dropped to almost 12% in 1983—down almost two and a half times from the peak share of the late Sixties.<sup>33</sup>

To take full advantage of new technologies in all of these activities, many businesses are finding it necessary to merge the data-processing, office automation, and telecommunication functions. Executing these functions often requires “large capital investments, large projects, large and complex implementation, and extensive user training.”<sup>34</sup> But, given the convergence of information and communication technologies, these three services can increasingly be provided via one network, allowing for considerable economies.<sup>35</sup>

Because these tasks were previously carried out independently of one another, the organizational changes required to execute this kind of restructuring can be quite extensive. In the past, for example, telecommunication services were purchased from AT&T, which constituted a quasi-public utility. Now, all sorts of purchasing decisions need to be made in a multi-vendor environment. And, as

**Figure 5-1-Structural Change and the Information Economy (investment and employment shares)**

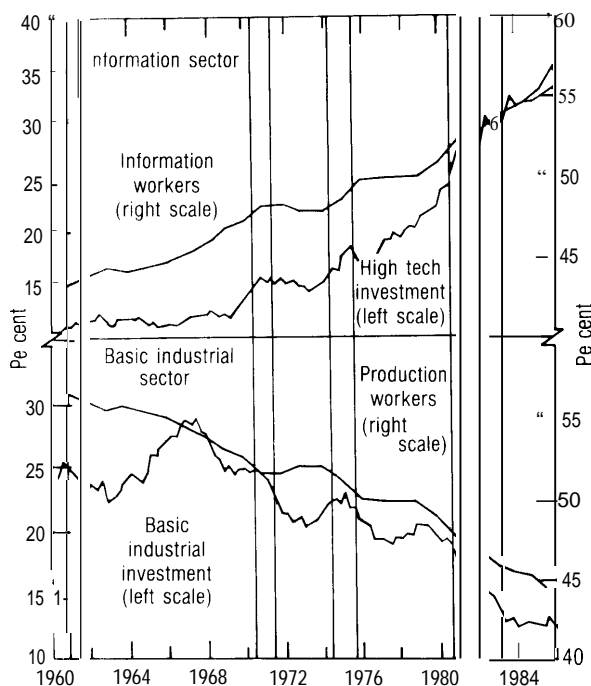

NOTE. Shaded areas indicate recessionary periods as designated by the National Bureau of Economic Research. Dashed lines indicate Morgan Stanley Economics projections.

SOURCE: Adapted from *Information Management Review*, vol. 1, No. 1, p. 14, with permission of Aspen Publishers, Inc., Copyright Summer 1985.

McKenney and McFarlan have pointed out, the situation is complicated by the fact that vendors from each of the three sectors are seeking to provide the overall technological base for all these services. In view of the fact that information plays a strategic role in configuring interorganizational relationships, a number of decisions also have to be made about where in the organization to locate the management, and whether or not the operations should be centralized or decentralized. How these questions are answered may have significant consequences for business since, as once corporate executive has noted, in an information economy, “a premium is

<sup>31</sup> Marchand and Horton, op. Cit., footnote 6, p. 16.

<sup>32</sup> Stephen S. Roach, “The Industrialization of the Information Economy,” testimony at hearings before the House Subcommittee on Economic Stabilization, June 12, 1984, pp. 6-7, as cited in *ibid.*, pp. 16-17.

<sup>33</sup> *Ibid.*

<sup>34</sup> James L. McKenney and E. Warren McFarlan, “Information Archipelago—Maps and Bridges,” *Harvard Business Review*, September-October 1982, p. 111.

<sup>35</sup> *Ibid.*

placed on managing information and not just on [its] automation.”<sup>36</sup>

Given the enhanced value of information, many firms and corporations that have never been involved in information-related activities before are, for the first time, beginning to see themselves as potential information-providers. A number of these companies are now repackaging their transactional data and computer software for sale. Both American Airlines and the Travelers Insurance Co., for example, have developed subsidiaries that sell software and training services to external customers. Through its subsidiary, Travtec, Travelers also markets a software package for managing IBM’s system network architecture (SNA) networks.<sup>37</sup>

In an information-based economy such as this, the role of communication technologies as a competitive weapon is likely to be greater than ever before. Information has become a key strategic economic resource, and communication technologies (as they have been combined with information-processing and storage technologies) the most effective means for taking advantage of it. In this context, businesses are less apt to be satisfied with simple access to a public communication network. Increasingly, they are looking for communication options that allow them greater management and control over their information resources.

### Trend Toward a Global Economy

A second but interrelated socioeconomic trend that will influence how new communication technologies will be perceived in, and used by, the business community is the trend toward a global economy. Like the trend toward an information economy, this development is likely to reinforce the inclination of business leaders to increasingly con-

sider their communication needs in more strategic terms.

From the U.S. perspective, the beginnings of a global economy can be traced back to the final decades of the 19th century and the rise of the large, multifunctional corporation, a number of which established branches or subsidiaries abroad. Many of these firms have continued to be highly successful. Taking advantage of being the first of their kind, they were able to use their size and complex corporate structures as effective barriers to entry to discourage potential, latecoming rivals.<sup>38</sup> U.S. multinational firms also had an advantage over their European counterparts, who were constrained in their operations by their much smaller domestic markets and, unlike American companies, were unaccustomed to competing on the basis of efficiency improvements and cost reductions.<sup>39</sup>

As European and Japanese economies recovered from World War II and managed to overcome the U.S. technological lead, however, this pattern of U.S. economic hegemony shifted significantly, and American multinationals increasingly found themselves competing intensely with their European and Japanese counterparts.<sup>40</sup> Japanese corporations, benefiting from their export-oriented industrial policy, have been particularly successful in their efforts to establish international connections by investing and producing abroad.

The proliferation of international economic actors has been facilitated and fostered by a number of developments. According to Michael Porter, these include:

- the growing similarity of countries, both with respect to tastes as well as to infrastructure, distribution channels, and marketing approaches;

<sup>36</sup>Marchand and Horton, op. cit., footnote 6, p. 24.

<sup>37</sup>Tom Valovic, “Public and Private Networks: Who Will Manage and Control Them?” *Telecommunications*, February 1988, p. 42.

<sup>38</sup>Chandler, op. cit., footnote 23, pp. 408-409.

<sup>39</sup>*Ibid.*, pp. 433-434. As Chandler has pointed out, in Europe, “the lack of antitrust legislation meant that market power was achieved and maintained in the domestic market far more by contractual cooperation than through functional and strategic differences. In those British industries where a single firm did not dominate, federations of relatively small, usually family enterprises, normally in the form of holding companies, maintained agreements as to price, output, and marketing territories.” Because of the dominant position of American firms, the term “multinational corporation” originally was, according to Robert Gilpin, “a euphemism for the foreign expansion of American giant oligopolistic corporations.” The strength of the U.S. economic position was reflected by the fact that, in 1981, more than two-fifths of the world’s direct foreign investment was accounted for by the United States, with the bulk of it being invested in advanced manufacturing. Moreover, foreign investment and the activities of American multinationals were increasingly critical to the U.S. economy in that, in the early 1970s, a sizable number of American corporations held more than \$500 billion of their assets and gained more than one-half of their earnings abroad. Robert Gilpin, *The Political Economy of International Relations* (Princeton, NJ: Princeton University Press, 1987), p. 238.

<sup>40</sup>*Ibid.*, p. 240.



- the emergence of a global capital market as witnessed by large flows of funds between countries;
- declining tariff barriers and the establishment of regional trading agreements;
- shifting opportunities for competitive advantage due to technology restructuring;
- the integrating role of advanced information and communication technologies;
- slow and uneven world economic growth that has fanned the flames of international competitiveness; and
- the emergence of new global competitors, principally from East Asia.<sup>41</sup>

Together, these developments have given rise to a global economy in which patterns of international trade now primarily reflect patterns of international production. Specialization takes place on the basis of parts and specialized components, rather than on the exchange of finished products as in the past. Today, for example, Japan provides approximately 40 percent of U.S. component parts in electronics and automobiles.<sup>42</sup> As Jack Behrman has pointed out, specialization has also taken place:

... based on different product characteristics: mass consumption versus high fashion, or low quality versus high quality, or generic versus trademarked goods.<sup>43</sup>

Whereas in the past most multinational corporations tried to exploit comparative advantage by producing or selling in a single country, in today's global environment they are seeking more the comparative advantage that can be gained by integrating all their activities on a worldwide basis.<sup>44</sup> To compete globally, firms must allocate all their

activities among a number of countries to gain the optimum advantage.<sup>45</sup> As Michael Porter has said:

In global competition, a country must be viewed as a platform and not as a place where all of a firm's activities are performed.<sup>46</sup>

Thus, depending on the particular case, it might be best for a firm to disperse many of its production facilities—such as design modification, fabrication, and assembly—to foreign countries, and to focus its own domestic production on the fabrication of key components.<sup>47</sup> Or, alternatively, a firm might decide to manufacture a product domestically, but transfer abroad such downstream activities as distribution, sales, marketing, and service.<sup>48</sup>

Vertically integrating all of these activities, modern multinational corporations generally take the form of large, international oligopolies.<sup>49</sup> And where corporations are not fully integrated at the global level, they are often becoming linked to activities in other countries through alliances and contractual arrangements such as cross-licensing of technology, joint ventures, orderly marketing agreements, off-shore production of components, secondary sourcing, and crosscutting equity ownership.<sup>50</sup>

In many cases, these multinational corporations are aided in their competitive endeavors by the increasingly protectionist and interventionist policies of their home governments. Whereas in the past protectionist policies generally were designed to protect an infant or declining industry, today they are calculated to enhance or even create a comparative advantage—especially in high technology, high value-added industries—by, for example, establishing export subsidies, tax incentives, or credit guarantees.<sup>51</sup> To the extent that governments can alter

<sup>41</sup>Porter (ed.), *op. cit.*, footnote 23, pp.2-3.

<sup>42</sup>*Ibid.*, p. 255.

<sup>43</sup>Jack N. Behrman, *Industrial Policies: International Restructuring and Transnationals* (Lexington, MA: Lexington Books, 1984), p. 72.

<sup>44</sup>Porter (ed.), *op. cit.*, footnote 23, p.19.

<sup>45</sup>*Ibid.*, p. 23.

<sup>46</sup>*Ibid.*, p. 45.

<sup>47</sup>*Ibid.*

<sup>48</sup>*Ibid.*

<sup>49</sup>Gilpin, *op. Cit.*, footnote 39, p.241. As Gilpin has pointed out, the key factors accounting for the expansion and success of this vertical form of multinational enterprise are similar to those that led to the domination of the Nation's economy by large oligopolistic corporations.

<sup>50</sup>Corporate incentives to make such international arrangements are very strong. They stem from a number of technological, political, and economic factors, including: 1) a rapidly changing, high-cost technology that requires large firms to spread their risks; 2) new economic protective measures, making joint agreements a requisite for gaining market access; 3) the enormous capital requirements needed to operate globally; and 4) access to new technology. *Ibid.*

<sup>51</sup>*Ibid.*, p. 216.

industry advantages, one can no longer speak of comparative advantage in the classic, economic sense, which calls for free trade.<sup>52</sup> Furthermore, these competitive policies are self-reinforcing. Because many countries are focusing their industrial policies in the same high-technology and service sectors, there tends to be overproduction in these areas and, hence, increased pressure for protectionist policies.<sup>53</sup> In the light of these developments, it is understandable why the international system of industrial production has been characterized as “a complex web of interlocking relations among nation states and the world’s giant corporations.”<sup>54</sup>

In such a highly competitive, global economy, companies must choose a worldwide strategy if they are to survive. Just as the railroad, telegraph, and telephone were essential to the development of the national corporation in the late 19th century, so, too, advanced communication technologies and networks will be essential to the modern corporation that seeks to pursue a global competitive approach. As the staff vice president for worldwide telecommunications at Unisys Corp., Detroit, has described it:

Networking on a global scale is now mandatory for Fortune 100-sized companies. . . . We agonized over buying some expensive circuits in some countries, but we don’t have that issue anymore. It’s too expensive not to order the stuff.<sup>55</sup>

### Key *Business Activities*

To examine concrete situations in which new communication technologies might give rise to opportunities and constraints, it is necessary to divide economic activity into a number of subcategories. In selecting these subcategories for analysis, this chapter borrows heavily from the work of Michael Porter, who has identified nine generic “value-generating activities” that all businesses carry out in the course of their operations.<sup>56</sup> Each of

these activities entails the formulation, exchange, and interpretation of information, and, hence, each might be significantly affected by the introduction of new communication technologies. As can be seen from table 5-1, Porter has divided the nine activities that he has identified into two groups: primary activities, which relate directly to the specific work that a firm does, and support activities, which are carried out on behalf of all activities.<sup>57</sup> For the purposes of this chapter, we will divide these activities into those of production and exchange.

### *Framework for Thinking About the Business Opportunities Presented by New Communication Technologies*

As we have seen from our historical account, communication technologies can affect:

- the speed of economic transactions;
- the distance that, within any given timeframe, economic information can travel; and
- the relationships and interdependencies among economic actors.

These three mechanisms for change are also employed by Michael Hammer and Glen E. Mangurian in the framework they have developed for analyzing how new communication technologies are expanding the realm of business opportunities.<sup>58</sup>

In addition to these mechanisms, Hammer and Mangurian also define three different kinds of value that might be created by the use of new communication technologies. These values are: 1) improvements in efficiency, 2) effectiveness, and 3) innovation. Changes in efficiency reflect new or modified means for accomplishing tasks. Such modifications typically signify alteration in the speed or cost of operations. Effectiveness measures the fit between means and ends—how well or how poorly an end or goal is realized by a particular means. Organiza-

<sup>52</sup>Ibid., p. 277.

<sup>53</sup>Behrman, op. cit., footnote 43, p. 1.

<sup>54</sup>Often focusing in areas involving advanced technologies, many of these corporations are very powerful. Their worldwide foreign direct investment in 1981 amounted to approximately one-half a trillion dollars, and the resources that many of them possess far exceed those of most nations. Ibid., p. 260.

<sup>55</sup>Margie Semilof, “Fortune 100,” *CommunicationsWeek*, CLOSEUP, June 13, 1988, pp. C12.

<sup>56</sup>Michael Porter, *Competitive Advantage: Creating and Sustaining Superior Performance* (New York, NY: The Free Press, 1985), ch. 2.

<sup>57</sup>Ibid., pp. 39-43.

<sup>58</sup>Michael Hammer and Glenn E. Mangurian, “The Changing Value of Communications Technology,” *Sloan Management Review*, vol. 28, No. 2, Winter 1987, pp. 65-71.

Table 5-I-Key Business Activities

Production
<ul style="list-style-type: none"> <li>• <i>Operations</i>, consisting of all those activities associated with the compilation of a product or a service, including design, manufacturing, and assembly.</li> <li>• Service, entailing activities designed to maintain or enhance product value.</li> <li>• Technology development, entailing the activities involved in research and development of all of the technological applications and know-how required by the firm.</li> <li>• <i>Human resource management</i>, entailing all of the activities required for recruitment, hiring, and training.</li> <li>• <i>Firm infrastructure</i>, entailing all those activities required for the planning, coordination, and management of a firm.</li> </ul>
Exchange
<ul style="list-style-type: none"> <li>• <i>Inbound Logistics</i>, entailing the activities involved in receiving, storing, and distributing product inputs.</li> <li>• <i>Outbound logistics</i>, entailing activities used in gathering, sorting, and disseminating finished products to buyers.</li> <li>• <i>Procurement</i></li> <li>• <i>Marketing and sales</i></li> </ul>

SOURCE: Michael Porter, *Competitive Advantage: Creating and Sustaining Superior Performance* (New York, NY: The Free Press, 1985), pp. 39-43.

tional and managerial controls are especially important here. Innovation signifies modified ends.<sup>59</sup>

Pairing impacts and values, Hammer and Mangurian have developed a matrix for identifying changes in business activities, as can be seen in figure 5-2. In the discussion that follows, no attempt will be made to fill in all of the nine boxes in the matrix; however, this framework is helpful for thinking about and classifying the changes in the economic realm that might be brought about by the use of new communication technologies.

<sup>59</sup>To identify all new business opportunities, it is necessary to employ the values of effectiveness and innovation, in addition to efficiency. As Parker and Benson have noted, traditional cost-benefit analysis is no longer adequate for most information systems' applications that are innovative or that produce or enhance revenue. Rather, to fully assess new business opportunities, one needs to take into account a diverse range of values such as nonfinancial returns on investment, the establishment of a strategic match, greater competitive advantage, improved information management, a better competitive response, and a more strategic reformation systems' architecture. Marilyn M. Parker and Robert J. Benson, "Information Economics: An Introduction," *Datamation*, Dec. 1, 1987, pp. 86-87. All of these aspects of value can be subsumed under Hammer and Mangurian's three terms.

<sup>60</sup>For example, if several machine tools are linked to the same mini- or micro-computer, a sequence of machine operations can be executed automatically. When one machine completes an operation, a signal is sent to the control computer, which then initiates the next machine operation in the sequence. In this fashion, overall processing time can be significantly decreased. Such intermachine communication is being facilitated by the deployment of the communication standard known as Manufacturing Automation Protocol (MAP). Barnaby Feder, "How the System Works at a GM Plant," *The New York Times*, June 15, 1988, p. D8. For a discussion of technology and business operations, see Abbe Mowshowitz, "Communication and Comparative Advantage in the Business Arena: Operations and Technological Developments," OTA contractor report, July 1988.

<sup>61</sup>Keen, *op. cit.*, fnmoted, pp. 49, 51. For example, an application for automobile or life insurance can be processed by entering client data at a remote terminal linked to the company's computer system. The information on the application can then be transmitted electronically to the underwriting department. After processing--determining risks, computing premiums, etc.--a completed policy document can be produced on the computer by entering the appropriate parameters in a file containing the basic policy form, and then directing the completed form to a printer.

<sup>62</sup>Judith Graham, "Bar Codes Becoming Universal," *Advertising Age*, Apr. 18, 1988, p. 36.

## ANALYSIS OF BUSINESS ACTIVITIES

### *Operations*

Business operations entail all of the activities that are associated with the compilation of a product or a service, including design, manufacturing, and assembly.

### Improvements in the Efficiency of Business Operations

Computer-based communication can yield more efficient business operations by reducing interaction time in the exchange of information between persons, between persons and machines, and between machines. In manufacturing, for instance, the introduction of computer links between machines speeds up production and assembly.<sup>60</sup> In service firms, such as insurance companies and banks, communication systems increase the efficiency of transaction processing.<sup>61</sup> A well-known example from banking is the reduction of time required to process letters of credit using computerized files accessible from workstations in several departments. In retailing, the use of machine-readable product codes and automatic scanners in supermarkets yields increased efficiency in store operations. Checkout time, inventory control, and accounting operations can all be improved by linking the cashiers' stations to the store's computer and automatically capturing sales information at checkout.<sup>62</sup>

With enhanced speed, the time required to communicate across geographic distance is greatly reduced, which allows businesses to integrate and coordinate activities distributed in space and create additional efficiencies. In the case of automobile

Figure 5-2--impact/Value Framework

Impact	Value		
	Efficiency	Effectiveness	Innovation
Time	Accelerate business process	Reduce information float	Create service excellence
Geography	Recapture scale	Ensure global management control	Penetrate new markets
Relationships	Bypass intermediaries	Replicate scarce knowledge	Build umbilical cords

SOURCE: Reprinted from "The Changing Value of Communications Technology," by Michael Hammer and Glenn E. Mangurian, *Sloan Management Review*, vol. 28, No. 2, Winter 1987, p. 66, by permission of the publisher. Copyright 1987 by the Sloan Management Review Association. All rights reserved.

manufacturing, for example, transportation and computer-based communication technologies have allowed companies such as General Motors to produce components in different regions of the United States and in other parts of the world and assemble them in a variety of locations. By distributing these operations, manufacturers have been able to take advantage of the special conditions in different regions, such as lower wage rates, cheaper material prices, less expensive power, and more liberal financing, etc., and thus reduce their production costs. Communication technologies, moreover, provide the links between central management and the various field units.<sup>63</sup> In addition, data communication facilities allow for real-time movement of information to and from computers, which is required to determine optimal, or near optimal, production schedules, resource allocation schemes, etc.<sup>64</sup>

The changed relationships brought about by the deployment of new communication technology have also resulted in greater efficiencies. This is evident in information systems where virtually all transac-

tion processing begins with data entry. Since this function is usually dependent on human operators, it tends to be slow and error-prone. The efficiency of data entry can be improved by bringing the data closer to the database, as the power utilities are trying to do by equipping meter readers with hand-held computers. These instruments store the readings gathered in the course of a day's rounds. Periodically plugging the portable device into the telephone network through a modem, the meter reader transmits the data to the company's computer system for processing. This procedure eliminates a whole link in the data-processing chain. In bypassing the data-entry clerk, the time between reading and billing is reduced, and the opportunity for recording erroneous information is diminished.<sup>65</sup>

### Improvements in the Effectiveness of Business Operations

The increased speed of communication can contribute to increased effectiveness by facilitating timely control, either periodically or on a real-time basis. Rapid information transfer figures prominently in the drive to improve effectiveness in manufacturing companies, for example. One such system is a network of machines in a factory. Instead of having to physically oversee operations on the shop floor, the foreman can get regular status reports from a computer in his office, as can the factory manager. Such reports might include, for example, an inventory of production volume for the whole factory, a list of equipment problems, or information on the work force.<sup>66</sup>

A more advanced application of computer-based communication technology would involve a factory cell designed to produce all parts to specification. Such a scheme is feasible when the machines in the cell are networked together and controlled by a computer. With continual machine reports on operations, the computer can determine, for example, whether a tool must be changed or some adjustment

<sup>63</sup>An increasing number of firms are using Very Small Aperture Terminal (VSAT) technology to provide these links. These firms include J.C. Prudential Bache. David Meyer, "Pru-Bache Invests in VSATS," *CommunicationsWeek*, Feb. 8, 1988, p. 1.

<sup>64</sup>In the service sector, communication technology is more closely associated with the end-product. Brokerage firms such as Merrill Lynch Prudential Bache buy and sell securities for millions of customers all over the United States and throughout the world. These customers are sales personnel in geographically dispersed offices. In banking, the automated-teller machine makes it possible for the retail banks to offer their services in a variety of locations and settings, some of which are not traditionally bank sites at all. For a discussion of the communication needs of financial institutions, see Deborah G. Tumey, "Financial Institution Communication Systems," OTA contractor report, December 1986.

<sup>65</sup>Matthew L. Wald, "Eliminating the Meter Reader," *The New York Times*, May 4, 1988, p. D7. The banking industry also exemplifies efficiency gains due to restructured relationships. For example, the automated-teller machine alters the relationship between the customer and the bank. The result is that the customer performs some of the tasks that used to be done by bank employees.

<sup>66</sup>These systems are commonly called Executive Information Systems (EIS). Mary dee Ojala, "Wiring the Top Execs," *Online Accounting*, January/February 1988, pp. 3740.

made before the given machine begins to turn out defective parts. Comparable network applications occur in all types of business.<sup>67</sup>

Effectiveness is also enhanced as a result of the greater control that technologies afford in directing and coordinating geographically dispersed activities and objects. In the pharmaceutical and chemical industries, for instance, companies have to coordinate the movement of an enormous variety of raw materials and end-products with hundreds of different classifications, as well as different packaging, stability, distribution mechanisms, and production constraints. Managing this geographically distributed body of information requires an information system with terminals or workstations linked by data transmission lines to databases in one or more computers.<sup>68</sup>

The ability to network communication among disparate locations also provides businesses with greater flexibility and, in so doing, improves their effectiveness. Because computer-based communication can monitor operations on a real-time basis, management can respond immediately to changes in demand and issue orders to one or more manufacturing plants to reduce or increase output accordingly. Moreover, because programmable machine tools can rapidly be redirected to machine cams, for example, instead of gears, new communication technologies permit manufacturers to tailor highly differentiated products to customer specifications.<sup>69</sup>

Altered relationships brought about by technology can also contribute to effectiveness. An important manufacturing example relates to the linkage between product design and engineering. To the dismay of many engineers and managers, the traditional separation of these two functions has often created a mismatch between product specifications and manufacturing processes. With the introduction of computer-aided design and computer-aided manufacturing, these two departments can be joined by setting up a networked database containing part

specifications that is accessible to both design and engineering departments. Such an arrangement would improve effectiveness by eliminating intermediate operations, thereby facilitating a tighter coupling of means and ends.<sup>70</sup>

### Innovative Business Operations

In addition to stimulating improvements in efficiency and effectiveness, the speed of computer-based communication makes it possible to do things that would otherwise be impossible. The distinctive features of the new communication technology in this regard are memory and processing power.

The financial services industry, for example, abounds with new products that are dependent on rapid computer-based communication. Retail banks offer electronic checkbooks to ordinary clients; merchant banks offer somewhat more sophisticated instruments to wealthy individuals and corporate customers. But all of these new products—portfolio, cash, and treasury management systems, as well as electronic checkbooks—require real-time access to market information.<sup>71</sup> An entirely new business that is being brought into existence by computer-communication is that of online vendors, such as Lockheed Data Systems, System Development Corp. (SDC), and Mead Data Central, who provide bibliographic, financial, legal, and many other types of data to a variety of business and government clients.<sup>72</sup>

In addition to speed, the distributive capabilities of the new communication technologies give rise to new opportunities for innovation. One such innovative product is a financial-industry offering called treasury management systems. These are designed to assist corporations in managing assets and liabilities—such as cash, notes, bonds, and debts—in various currencies throughout the world. Workstations and software are supplied by the bank. The corporate client can obtain account information and a variety of other data, such as currency exchange rates, from the workstation that is connected to the

<sup>67</sup>Gains in this area can be considerable. In the United States, for example, one fourth of all manufacturing costs goes into maintaining quality. The costs tend to be high because product defects are generally only detected at quality-control stations at the end of the assembly line. Manfred Kochen, "Advanced Information Technology and Small Manufacturers," *Science*, April/May 1986 p. 26.

<sup>68</sup>Semilof, *op. cit.*, footnote 55, pp. C12-C13.

@Ibid.

<sup>70</sup>John Krouse, "Engineering Without Paper," *High Technology*, March 1986, pp. 38-46.

<sup>71</sup>Keen, *op. cit.*, footnote 6, p. 45.

<sup>72</sup>See Peter W. Huber, *The Geodesic Network: 1987 Report on Competition in the Telephone Industry*, Antitrust Division, U.S. Department of Justice (Washington, DC: U.S. Government Printing Office, January 1987), ch. 7.

bank's computer. Apart from providing "electronic checkbook" services, treasury management systems offer decision support on the choice of investment vehicles.

Restructured relations can also affect innovation. New shipping services, for example, involve installing computer terminals in customers' offices. Through these terminals, shippers can communicate with a shipping company's computer, both to initiate transactions and obtain information about shipments. This direct connection between shippers and shipping companies reduces dependence on intermediaries such as freight forwarders and customs boarders.<sup>73</sup> The cash management and treasury management systems offered by banks also allow customers direct access to banking computers. These new offerings exemplify the substitution of products for traditional services.

### Service

Providing after-sale service includes activities that enhance the value of one's product, such as installation, repair, training, parts supply, and product adjustment.<sup>74</sup>

### Efficiencies in the Provision of Service

With rapid computer-based communication, producers can now design systems that speed and facilitate service. Some systems provide instructions for repair and service; others repair problems as they arise. Many new photocopying machines, for example, display a coded message indicating a problem and what it entails. Some products even have instructions for repair embedded in them. Machines can also be linked to fault-analysis computers operated by producers. In this fashion, one heavy-machine manufacturer has designed its system so that when a customer's machine fails, it automatically sends a signal to the manufacturer and diagnostic information is returned immediately. Meanwhile, spare parts are dispatched and the firm's field service

unit is alerted.<sup>75</sup> In some cases, repairs can be made online, as in an automated factory.<sup>76</sup>

### More Effective Service Provision

By improving customer service, these gains in efficiency also give rise to greater effectiveness. Using a computer-based communication network, Mercedes Benz, for example, not only provides car owners with a toll-free 800 number to call for service; it also helps the driver to find a service provider, no matter where in the United States the driver might be. Mobile telephone and paging services also improve service delivery by linking repair personnel to their offices while they are on the road.<sup>77</sup> With continual access, they can easily learn about schedule changes and hear directly from clients. Improvements of this kind make firms more competitive.

### Innovations in Customer Service

By allowing producers to maintain records that are more accessible and detailed, computer-based communication technologies give manufacturers a chance to create new service products. For instance, one pharmacy uses its database to analyze the combination of drugs sold to individuals to discover whether they might create dangerous synergisms.<sup>78</sup> Service providers can also provide ancillary services based on the data they collect about buyer purchases. For example, one national drug company offered their pharmacy customers detailed analyses of their sales, including the profitability and turnover ratios of different items, based on their orders over a period of time.<sup>79</sup> The company also offered to print price labels for pharmacies. Bar-code scanners allow retailers to sell producers special "maintenance" services, detailing information about buyers' purchasing habits.

### Technology Development

Technology development is a support function within the firm. It consists of all of the activities that

<sup>73</sup>The trucking firm, PIE Nationwide, Inc., updates its customers' computer three times a day, giving the location of each shipment and listing any problems. David Wessel, "Computer Finds a Role in Buying and Selling, Reshaping Business," *The Wall Street Journal*, Mar. 18, 1987, pp. 1, 10.

<sup>74</sup>Porter, *op. cit.*, footnote 56, p. 40.

<sup>75</sup>Keen, *op. cit.*, footnote 6, p. 54.

<sup>76</sup>Cash et al., *op. cit.*, footnote 6, p. 52; see also Clemens and McFarlan, *op. cit.*, footnote 6, p. 95.

<sup>77</sup>See Alan A. Reiter, "New Pagers Put a Mailbox in Your Pocket," *High Technology Business*, April 1988, p. 32.

<sup>78</sup>David Stipp, "Scientists Use Medical-Record Data Bases to Detect Adverse Side Effects of Drugs," *The Wall Street Journal*, Mar. 24, 1988, p. 33.

<sup>79</sup>Keen, *op. cit.*, footnote 6, p. 47. A major distributor of magazines to newsstands and stores used its sales records to produce sales analyses for its small, unsophisticated customers about their absolute and relative standings. Cash et al., *op. cit.*, footnote 6, p. 46.

are associated with research and development with respect to all technological applications and specialized knowledge required by the firm.

### **Efficiency Improvement in Technology Development**

The increased speed of transmission and processing contributes greatly to efficiencies in technology development. For example, online retrieval systems, such as those offered by Lockheed and SDC, greatly facilitate and reduce the costs of tracking developments in any given subject area. Electronic mail and computer-conferencing are also important in maintaining research networks. Not only does electronic mail have the virtue of speed, like the telephone; it also frees parties from having to be simultaneously connected to a common communication channel. Such informal exchanges keep those in the network abreast of latest developments long before the appearance of formal publications and presentations. Computer-conferencing couples the message-handling capabilities of electronic mail with the file-management facilities of a computer system, enabling groups of researchers to participate in seminars that have neither a fixed schedule nor a fixed location.

By overcoming geographic restrictions, new communication technologies allow businesses to take advantage of the economies of global technology development. Efficiency gains are particularly evident in two areas: intelligence gathering and professional networking. One way of carrying out these two activities is to set up and maintain listening posts to monitor R&D centers throughout the world. One example is the program setup by the Advanced Products Manufacturing Engineering Systems group (APMES) at General Motors' Technical Center in Warren, MI. Designed to systematically follow all technological developments related to automobile manufacturing, listening posts that report back to headquarters regularly have been established in most major R&D centers.

Changed relationships also create new efficiencies in technology development. High-speed data transfer between computer systems eliminates the need for human intermediaries to transmit informa-

tion. This improves efficiency in joint projects that involve more than one research center, as well as in projects consisting of a sequence of tasks that share the same database. In the first case, efficiencies would result from the timely exchange of data; in the latter case, from better coordination.

### **Enhancements in Effective Technology Development**

Enhanced effectiveness associated with time compression is most evident in the area of R&D management. By making it possible to monitor activities on a real-time basis, computer networks allow managers to track the progress of various teams and subgroups in a large project. By using the technology to implement a matrix system of organization, management can use all of the organization's resources to their best advantage. This ability is especially useful for technology development because of the difficulty in anticipating and concentrating all of the expertise required for a complex research project.

More effective technological development can also be brought about through changed relationships. In some companies, research data are now being integrated into other corporate information systems, allowing for their more effective use throughout an entire organization. For example, the integration of systems at the Marion Laboratories Inc. allows the R&D department to send the formula for a new drug, along with the engineering process control data, directly to the manufacturing department. This same information is sent to the sales and marketing department where it is used to help create educational materials for physicians to use when testing the drug.<sup>80</sup> Similarly, the R&D department at a Detroit auto-parts manufacturer has developed a computerized performance program that allows the department to evaluate bearings and transmit specifications to their automotive customers via the corporate mainframe.<sup>81</sup>

### **Human Resource Management**

Human resource management entails all of those activities required for recruitment, hiring, and training of company personnel.

---

<sup>80</sup>David Stamps, "In Search of Synergy: Linking R&D to Corporate IS," *Datamation*, July 1, 1988, p. 71. For a discussion of communication technology and technology development, see Mowshowitz, op. cit., footnote 60.

<sup>81</sup>Ibid.

## Efficiencies in Human Resource Management

One way to reduce the cost of training is to reduce the travel time and costs necessary to aggregate trainers and trainees in a single geographic location. Transmission media allow for this by linking dispersed trainers and trainees via satellite and wire lines. Live presentations can be communicated to trainees who can ask the trainer questions via voice links. Interactive training sessions may take the form of teleconferences or video conferences especially tailored for a single company or to address a narrow issue.<sup>82</sup> Hewlett-Packard was one of the first to design such a program in 1983, installing satellite receivers at 50 field offices.<sup>83</sup> By the end of 1987, about 40 companies had followed suit, setting up private video networks linking more than 6,000 sites. In addition, a number of companies joined together to establish one entity, the National Technical University (NTU), which offers regularly scheduled videoconferencing courses.<sup>84</sup> The costs of videoconferencing are declining, due to new compression and slow scan video technologies that allow pictures to be sent over a handful of telephone lines.<sup>85</sup>

## Effectiveness in Human Resource Management

While communication networks can bridge geographic distances between trainers and trainees, the use of new storage media, given their portability, is often more effective. Like books, stored media can be consulted at the convenience of trainees, at their workplace or even at home. Moreover, difficult portions of the material can be repeated, with trainees working at their own pace. Videotapes are also being used to tape the actions of trainees so their behavior can be observed and critiqued. Trial

lawyers, athletes, salespeople, and managers are among those who have found such devices beneficial.

The interactive capabilities of computers also enhance training effectiveness. Computer simulations, for example, allow trainees to interact with others on two levels—indirectly through the computer program, and directly as part of the simulation.<sup>86</sup> Using computer-based training, the Department of Defense has been particularly pleased with how it has helped teams of tanks to work together in maneuvers.<sup>87</sup> Other evidence suggests that when course-work is well designed, incorporating simulation and expert analysis or supervision, computer-based training can raise the productivity of training significantly.<sup>88</sup>

Interactive video/CD-ROM has also proved to be an excellent training device. Its high visual quality, features such as touch-screens, and ability to simulate actual equipment and situations and focus on individual learning problems make this technology particularly engaging.<sup>89</sup> As the cost of producing interactive video software declines, videodisks are becoming more competitive with videotapes.

## Firm Infrastructure

The infrastructure of a firm entails all of those activities required for planning, coordination, and management.

## Enhanced Efficiency and Effectiveness in Maintaining the Firm's Infrastructure

Just as computer-based communication can make business operations more efficient and effective, they can also be employed to plan, coordinate, and

<sup>82</sup>Herb Brody, "Business TV Becomes Big Business," *High Technology Business*, May 1988, pp. 26-30; U.S. Congress, Office of Technology Assessment, *Technology and the American Economic Transition Choices for the Future*. OTA-TET-283 (Washington, DC: U.S. Government Printing Office, May 1988), p. 251; and B. Zimmer, "A Practical Guide to Video Conferencing," *Training and Development Journal*, May 1988, p. 84.

<sup>83</sup>Brody, op. cit. footnote 82, p. 26.

<sup>84</sup>Headquartered in Fort Collins, CO, NTU now coordinates more than 450 courses offered by faculty from more than 24 participating universities! to students at more than 40 companies (in more than 60 sites equipped with satellite dish receivers) as part of a Master's degree program. NTU fills two channels (on a Ku-band satellite) 24 hours a day with both live and taped courses. Other business-TV networks that provide training services to multiple companies include Automotive Satellite Television Network, Food Business Network, and Hospital Satellite Network. Ibid.

<sup>85</sup>Susan Dillingham, "Videoconferencing May Get Less Costly," *Insight on the News*, May 9, 1988, p. 47.

<sup>86</sup>Shlomo Maital and Kim Morgan, "Playing at Management," *Across the Board*, April 1988, pp. 54-62.

<sup>87</sup>Ibid.; see also Office of Technology Assessment, op. cit., footnote 82, p. 59.

<sup>88</sup>Another form of computer-based training, called embedded instruction, involves the design of microchips within machines so that workers can be automatically instructed about how the machines should be used and repaired. Office of Technology Assessment, op. cit., footnote 82, p. 246; see also U.S. Congress, Office of Technology Assessment, *Technology and Structural Unemployment: Reemploying Displaced Adults*, OTA-ITE-250 (Springfield, VA: National Technical Information Service, February 1986), p. 292.

<sup>89</sup>Ibid., *Technology and Structural Unemployment*, p. 298. The capability of interactive feedback not only permits trainees to minimize repetition and to repeat difficult materials at their own pace; it also means that trainee programs can be custom-tailored to each trainee's progress.



manage the affairs of the entire firm, no matter how dispersed the operations are or where they are carried out. The OTIS elevator company, for example, which was previously comprised of 100 local offices, now employs a computer-based communication network to centrally coordinate the activities of its repair force. When clients call, they report their problem to a highly trained and perhaps multilingual operator, who records the information in a computer and dispatches repair personnel via a telephone/ beeper system. When the repair is made, the information is again stored in the computer so that senior management can track repair efforts and deal with special problems, perhaps requiring specialists, as they arise. Moreover, the recorded fault data, which are also immediately available to the company's engineers and designers, can be analyzed by management to see if there are any recurring problems that might require more general corrective action. With a system such as this, problems can be dealt with much more expeditiously than previously when up to five levels of management stood between the problem and the solution.<sup>90</sup>

Similarly, a major hospital center in Boston uses a relational database to carry out day-to-day management, to perform retrospective analysis, and to plan for the future.<sup>91</sup> This database keeps track of the "products" the hospital provides (such as a particular kind of operation), as well as the hospital resources that will be required to provide them. Using this product/resource list for annual planning purposes, the hospital will multiply each set of resources by the number of patients expected in each category. The hospital can also keep track of the use of resources—in terms of resource category, department, product, or physician—on a day-to-day basis, as patients are cared for. Moreover, the hospital can improve its budget planning process by making detailed comparisons of past budgets.<sup>92</sup>

### *Inbound Logistics*

In the past, businesses that did not want to risk running out of particular materials or products were forced to stockpile large quantities of inventory,

which not only tied up their money but also increased their physical storage costs. Today, they use computers to store inventory data and optical scanners and other input devices to instantly adjust inventory levels, significantly reducing their costs. Even more significant may be the ability of suppliers and customers to share such inventory data in a common database. For when suppliers have access to customers' inventory levels, they can institute just-in-time purchasing.<sup>93</sup>

### *Outbound Logistics*

By employing new communication technologies to help provide delivery service of both tangible goods and less tangible information products and services, producers and retailers can expand their markets. The greatest difficulty in coordinating delivery is the task of handling the data of multiple buyers and sellers, and developing the most efficient schedules to accommodate multiple needs. These tasks can be easily handled with standardized forms and computer-based communication, as overnight delivery services, such as Federal Express and United Parcel Service, have clearly demonstrated. A less centralized form of online coordination is being used by truckers in France who consult a special Minitel "deliveries needed" database when they have extra space in their trucks.

Where the cost of home delivery is inherently expensive due to low population densities or poor traffic conditions, another delivery alternative might be to use network arrangements to set up central pick-up locations, much as banks have done with automated-teller machines. "Enhanced private post offices" such as these already exist.

The delivery of information products and services can be made still more efficient by using new communication technologies that provide video entertainment to the home for a fee. Moreover, with optical fibers, video entertainment could be delivered on demand in the form of what might be best described as a video jukebox.

<sup>90</sup>John F. Rockart, "The Line Takes the Leadership--IS Management in a Wired Society," *Sloan Management Review*, Summer 1988, p. 58.

<sup>91</sup>Ibid.

<sup>92</sup>Ibid.

<sup>93</sup>Richard J. Schonberger and James P. Gilber, "Just-in-Time Purchasing: A Challenge for U.S. Industry," *California Management Review*, vol. 26, 1983, pp. 54-68.

## Procurement

### Efficiency

The new communication technologies are permitting firms to improve the efficiency and effectiveness of their procurement processes. Already, many firms are using electronic data interchange (EDI) networks to place orders, and thus avoid the time and trouble of filling out procurement forms.<sup>94</sup> In fact, some firms even refuse to purchase from suppliers who are not equipped with EDI.<sup>95</sup>

Firms are also using electronic networks to do better and more economic comparative shopping. Using electronic market networks to connect with a number of sellers, businesses can, first, eliminate those suppliers whose products are clearly inappropriate, and second, compare the rest of the offerings quickly and economically.<sup>96</sup> For this purpose, some firms insist on having access to their suppliers' inventory records and prices.

Procurement might eventually even be automated. As James Cash has pointed out, the combination of computers and standard communication protocols facilitates comparison shopping, and hastens the day when manufacturers will use their computers to scan suppliers' computers and automatically place orders for the best deals.<sup>97</sup>

The opportunities for efficiency gains in procurement are especially great when firms are purchasing information services. The use of electronic networks to share databases greatly reduces information costs. Law firms that need immediate access to a wide range of judicial decisions can now secure this information by subscribing to Lexis or Westlaw at a fraction of the cost of stocking a firm law library. And high-speed, high-capacity data links make it possible for firms to have data processing services conducted off-site by firms such as Electronic Data Systems. In this fashion, geographically dispersed firms can share the benefits of a supercomputer for their processing needs. In addition, with access to long-distance suppliers, firms can now treat quality

and expertise as more important selection criteria than geographic location.

## Marketing and Sales

### Efficiency

Rapid, computer-based communication allows for increased efficiencies in both marketing and sales. And, with reduced costs, producers and retailers are able to carry out their operations much more effectively than ever before.

Given cost constraints, for example, producers and retailers try to limit their advertising audiences to those who, on the basis of some preestablished set of characteristics, would be the most susceptible to it. Identifying the appropriate audience requires market research analysis about past buying habits and consumer tastes. The better the data, the more cost-effective the advertisement. Improved storage and reprocessing capabilities make it economical to collect more of these market research data and to combine them with other data for quick and effective analysis.

Manufacturers can also target their advertising using narrowcasting cable systems. For example, advertisers can now reach young people through MTV, the highly educated through Cable News Network, or the sports-minded through the Entertainment Sports Programming Network.<sup>98</sup> And, for advertisers who lament the days of fewer but larger audiences, there is the option of making a single call to make a cross-buy—that is, to place a single message on multiple channels to reach all audiences.<sup>99</sup>

As the penetration of personal computers and modems increases, there will be another way to distribute advertising. Already messages can be sent via electronic mail, but new videotex systems offer opportunities that are much more novel. The Prodigy system introduced by Trintex is an example. Advertisements are included within other messages along the lines of a newspaper ad, but with a number of key

<sup>94</sup>Willie Schatz, "EDI: Putting the Muscle in Commerce and Industry," *Datamation*, Mar 15, 1988, pp. 56-64. See also Michel Ball, "EDI Takes Root," *Computerworld*, Sept. 7, 1988, pp. 23-26; Paul Korzeniowski, "User Push Is on for International EDI," *CommunicationsWeek*, Jan. 9, 1989, pp. 1, 40; and Mitch Betts, "Lawyers Fret Risks Over EDI Growth," *Computerworld*, Jan. 16, 1989, p. 17.

<sup>95</sup>Ibid.

<sup>96</sup>Wessel, *op. cit.*, footnote 73, pp. 1, 10.

<sup>97</sup>Daniel Bell, "The World and the United States in 2013," *Daedalus*, vol. 116, No. 3, Summer 1987, P. 12.

<sup>98</sup>Joanne Lipman, "Fourteen Cable Networks Form Alliance to Offer Advertising Time in Package," *The Wall Street Journal*, Feb. 19, 1987, p. 12.

<sup>99</sup>Ibid.

differences. First, the ads are presented as “ticklers” that viewers may ignore or pursue further by request. Second, the ads can be stored so that they are only offered to viewers whose personal profiles meet the target requested by the advertiser. Third, the advertiser can be charged based on the number of viewers that actually choose to see the ad.

New communication technologies are also reducing the cost and effort required to produce advertising. Desktop publishing equipment permits manufacturers to create and send printed materials more easily and less expensively. Even more savings can be obtained using automatic-dialer, recorded-message-player machines.

In addition to generating savings in marketing, new technologies also give rise to more cost-effective sales. Computer-based communication permits simple orders to be taken by automated systems 24 hours a day, and more complex orders to be placed and processed more quickly and efficiently. Simple orders, for instance, can be taken by basic audiotext systems that employ branching programs to query customers and, on that basis, create individualized orders. More complex orders, entailing large amounts of data and difficult forms, can be handled using computerized, standardized purchase orders sent via dedicated EDI lines.

### Effectiveness

Some commercial information that changes rapidly—such as financial data or information regarding the availability of items in limited supply—is extremely time-sensitive. Moreover, making purchasing choices on the basis of such information often requires simultaneous comparison of data. To deal with such situations, networking technologies are proving very successful because they can be used to create virtual markets.<sup>100</sup> These networks are being established in a number of different ways. In some cases, sellers, such as airlines, are creating their own systems and offering buyers access to their databases.<sup>101</sup> In others, independent third parties are establishing network markets to connect multiple

buyers and sellers. Comp-U-Card, for example, connects more than 500 manufacturers, wholesalers, and retailers on one computer database for home shopping.<sup>102</sup>

Manufacturers and retailers are also using transmission and storage technologies to extend the geographic reach of their markets. The increasing number of video transmission channels—able, multichannel multipoint distribution service (MMDS) [also called wireless cable], and low-power television (LPTV)—permits sellers to let buyers browse through products on live or taped home-shopping television programs. However, because these media are not interactive, this form of teleshopping is limited in how responsive it can be to buyers’ specific needs. By far, the most effective technologies for storing and accessing large quantities of commercial information are compact disks, floppy disks, video cassettes, and even digital paper. These storage media permit tens of thousands of pages/frames of information to be distributed to consumers, and trends suggest that storage levels will significantly increase over time. With the penetration of VCRs to 53.8 percent of U.S. households, sellers are encouraged to produce full-motion video catalogs or videologs of their products. Although even more advanced storage media are now available, the hardware required for their use is too costly for consumers. One way of decreasing display costs is by information-sharing via an electronic network.

Changed relationships can also lead to improved marketing and sales effectiveness. By offering buyers hardware and software that facilitate electronic data interexchange, the seller can cement his relationship with the buyer because he makes it more expensive for the buyer to switch to other suppliers.<sup>103</sup> Some sellers have gone one step further, helping buyers to determine what orders to place, given their past ordering record and general industry sales. The McKesson drug company, for example, uses such a system to encourage the sale of its drugs to pharmacies.<sup>104</sup>

<sup>100</sup>Robert I. Benjamin, Thomas W. Malone, and JoAnne Yates, “Electronic Market and Electronic Hierarchies,” Sloan School of Management Working Paper, #1770-86, April 1986.

<sup>101</sup>In fact, airlines are now joining together to share the costs and to facilitate buyers’ access. Helen Wheeler, “New Savvy in the Skies,” *High Technology*, November 1987, p. 36.

<sup>102</sup>Russell Mitchell, “How Comp-U-Card Hooks Home Shoppers,” *Business Week*, May 18, 1987, p. 73.

<sup>103</sup>Schatz, *op. cit.*, footnote 94, pp. 56-@.

<sup>104</sup>“An Electronic Pipeline That’s Changing the Way That America Does Business,” *BusinessWeek*, Aug. 3, 1987, p. 80.

## Innovation

The widespread use of storage and reprocessing technologies in business is creating new sources of marketing data for advertisers. Many businesses initially adopted computers to improve the speed and accuracy of billing as well as coordination. However, given the decline in information-storage costs and the growing value of transactional data, many of these businesses now recognize the market value of their records.<sup>105</sup> Most travel agents, hospitals, banks, universities, insurance companies, and cable television systems, among others, record their marketing data for their own purposes or to sell to others. The development and widespread use of optical scanning technologies by retailers will undoubtedly stimulate this trend.<sup>106</sup> Also, single-source research firms are now monitoring the TV shows people watch, where they shop, the coupons they use, the brands they buy, and even the newspapers they read.<sup>107</sup>

## IMPACTS ON ECONOMIC PLAYERS

The deployment of new communication technologies in the past has given rise to uneven effects. Similarly, the uses of communication technologies, as described in this chapter, will entail losses for some and create benefits for others. Commenting on the differential impacts of new technologies with respect to competition among firms, Michael Porter has noted, for example:

[Technology] is also the greatest equalizer, eroding the competitive advantage of even well entrenched firms and propelling others to the forefront. Many of today's great firms grew out of technological changes that they were able to exploit. Of all the things that change the rules of competition, technological change is among the most prominent.<sup>108</sup>

To determine the structural impacts of new communication technologies and how their costs and benefits might be distributed within the economic realm, it is necessary to identify the players involved in economic activities and describe the basis on which they are related to, or dependent on, one another. As before, production activities will be treated separately from exchange activities to reflect differences in players, the environments in which they operate, their roles, and their motivations.

### *Players and Role Relationships in Production Activities*

Production entails the acquisition, coordination, and use of labor, capital, and technology to create goods or services. The ways in which people have organized to carry out these activities, and the socioeconomic or philosophical principles that have served to legitimate particular kinds of work relationships, have varied considerably over time and in different historical and cultural circumstances.<sup>109</sup> In preindustrial societies production was carried out, for the most part, within the family system.<sup>110</sup> With industrialization and the expansion of markets, the tasks that comprised the production process became highly differentiated and specialized, requiring that bureaucratic organizations, in the form of corporations, be established to integrate them.<sup>111</sup>

Because most business organizations are formalized and relatively structured, their members' roles and relationships are reasonably well defined. Using the schema developed by Henry Mintzberg, as depicted in the shaded area in figure 5-3, we can identify five major players involved in the internal, productive activities of a corporation. They are the:

1. chief executive officer, who assumes the position at the top of the hierarchy of authority;
2. operators, who are responsible for producing goods and services, and those who provide

<sup>105</sup>Eileen Norris, "Databased Marketing Sets Enticing Bait," *Advertising Age*, Jan. 18, 1988, p. S10.

<sup>106</sup>Stewart Brand, *The Media Lab: Inventing the Future at MIT* (New York, NY: Viking Press, 1987).

<sup>107</sup>Joanne Lipman, "Single Source Ad Research Heralds Detailed Look at Household Habits," *The Wall Street Journal*, Feb. 16, 1988, p. 39. Of course, as already mentioned, this information is made more valuable by reprocessing technologies that enable market researchers to analyze the massive amounts of data collected.

<sup>108</sup>Porter, *op. cit.*, footnote 56, p. 164.

<sup>109</sup>Zuboff, *op. cit.*, footnote 5, pp. 224-244.

<sup>110</sup>For a description of the production of textiles in England both before and after industrialization, see Neil J. Smelser, *Social Change in the Industrial Revolution: An Application of Theory to the Lancashire Cotton Industry 1779-1840* (London: Routledge & Kegan Paul, 1976).

<sup>111</sup>For a sociological account of the role of bureaucratic organization in economic developments, see Beniger, *op. cit.*, footnote 11. For an historical account of the emergence of the modern industrial corporation, see Chandler, *op. cit.*, footnote 22.

Figure 5-3--The Cast of Players

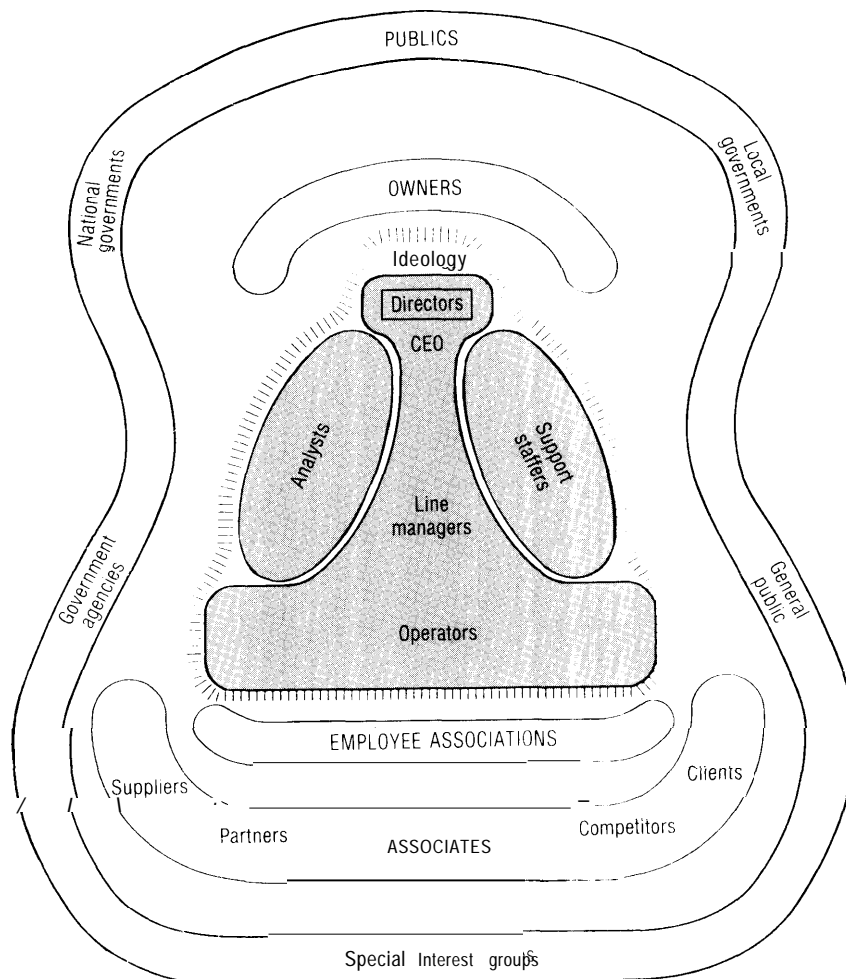

SOURCE: Henry Mintzberg, *Power In and Around Organizations*, Copyright 1983, p. 29. Reprinted by permission of Prentice-Hall, Inc., Englewood Cliffs, NJ.

- direct support for them;
3. line managers, "who stand in the hierarchy of line authority from the CEO down to the first-line supervisors to whom the operators formally report;"
  4. analysts of the technostructure, whose work entails the design and operation of planning and control systems; and

5. support staff, including secretaries, researchers, and legal counsel.<sup>112</sup>

Table 5-2 summarizes the roles and relationships among these five different sets of players in business organizations, and describes how members of each group typically use their influence within different spheres to achieve their primary goals. By examining how the deployment of the new communication

<sup>112</sup>Henry Mintzberg, *Power In and Around Organizations* (Englewood Cliffs, NJ: Prentice-Hall, Inc., 1983), pp. 232-233.

Table 5-2—The Internal Influencers and Their Play of Power

	Their <i>role</i> in the Internal Coalition	The <i>goals</i> they favor	Their prime <i>means of influence</i>	Their main <i>reasons for displacement of legitimate power</i>	Their fields of <i>play</i> of internal power	Their favorite <i>political games</i>
Chief Executive Officer	Overall management of it.	Survival and growth.	Authority (personal and bureaucratic), privileged knowledge, privileged access to the influential, political skills, sometimes ideology as well.	Maintain personal power.	Decisionmaking.	Strategic candidate, counter-insurgency.
Line managers	Management of its individual units.	Growth above all (of units and organization), survival, balkanization.	Authority (decreasing as descend hierarchy), privileged information, political skills, sometimes expertise.	Distortions in objectives, suboptimization, direct links to external influencers.	Decisionmaking, advice giving, and execution (with respect to upper levels).	Sponsorship, alliance and empire building, budgeting, line v. staff, strategic candidate, rival camps, sometimes lording, insurgency, and young Turks.
Staff analysts	Design and operation of its systems of bureaucratic control and adaptation.	Bureaucratization, economic efficiency, perpetual but moderate and well-regulated change, professional excellence.	Bureaucratic controls, expertise.	Means-ends inversion, direct links to external influencers.	Advice giving.	Expertise, line v. staff, strategic candidate, sometimes whistle blowing and young Turks.
Support staffers	Indirect support of its operating functions	For professional staff collaboration, perpetual but moderate change, professional excellence, for unskilled staff: protection of social group.	Expertise (for professional staff), Political will (for unskilled staff, when act in concert).	Suboptimization, means-ends reversion, direct links to external influencers.	Advice giving	Expertise, strategic candidate (for professional staff).
Professional operators	Provision of its operating functions,	Autonomy, enhancement of specialty, professional excellence, mission.	Expertise.	Means-ends inversion, direct links to external influencers,	Decisionmaking, execution.	Expertise, strategic candidate, sometimes young Turks.
Unskilled operators	Provision of its operating functions.	Protection of social group.	Political will (when act in concert).	Group means-ends reversion.	Execution.	Insurgency, lording, whistle blowing.

SOURCE: Henry Mintzberg, *Power/n and Around Organizations*, Copyright 1983, pp. 232-233, Reprinted by permission of Prentice Hall, Inc. Englewood Cliffs, NJ.

technologies, as they are applied to create new business opportunities, might affect each set of players' roles, goals, and means of influence—as they are described in this table—we can draw some conclusions about how improvements in efficiency, effectiveness, and innovation might affect those involved in the production process.

### ***Potential Impacts of New Business Opportunities on Players in the Production Process***

#### **Chief Executive Officer**

In the discussion of business opportunities, we have seen how computer networking and decision-making tools can provide managers with greater control and more timely and convenient information. At the same time, however, if these communication systems are poorly planned and deployed, they can contribute to poor decisionmaking and the deterioration of top management's authority.

Within a business firm, communication has traditionally been channeled and controlled by the people occupying positions in the management hierarchy. The rules governing communication reflect the organizational patterns of authority. Managers up and down the line interpret and pass on messages to those above and below them in the hierarchy. In the process, messages are sorted out, refined, and tailored to the organizational needs of the receiver. In this fashion, the chief executive maintains and supports his privileged position as the most knowledgeable—and, hence, the most powerful—person in the organization.

Bypassing many of these organizational gatekeepers, computer networks open the doors to both unauthorized communication and information overload, making it harder for chief executive officers to perform their roles. The distribution of electronic information is hard to control, and it can be exchanged or destroyed without a trace. Moreover, on computer networks, information tends to be distributed casually, to everyone, so that all receivers have to read each message and determine its particular value for them. Communication over computer networks also tends to be very informal

and imprecise.<sup>113</sup> Electronic mail is, moreover, subject to considerable misinterpretation, because it “does not provide the receiver with any contextual clues about the sender's intent.”<sup>114</sup> Given so many possibilities for distortion, the information the chief executive receives through electronic channels may be greatly inferior to that which is filtered through the organizational hierarchy.

Recognizing the linkages between electronically mediated communication and the quality of information received, many top executives are now becoming increasingly involved in the design of corporate communication systems.

#### **Operators**

Operators carry out the basic work of a business organization. Being the furthest away from the center of authority, they have minimal personal leverage, especially if they are unskilled.<sup>115</sup> To have an effect on the organizations for which they work, and to be able to influence their roles within them, operators have had to band together to act in concert. Given their lack of personal influence and their dependence on their cohorts, it is not surprising that, of all of those who are involved in production activities, operators identify the least with the organization's formalized goals, and value very highly their established social relationships with peers.

To the extent that operators have no organized base of power, they will have little control over how communication technologies are employed in the work environment. Much will depend, therefore, on how management regards the opportunities presented by new communication technologies. As the OTA report, *Computerized Manufacturing Automation: Employment, Education, and the Workplace*, pointed out:

Depending on how tasks are arranged and jobs designed, programmable automation has the potential to decrease the amount of autonomy, control, and challenge available to the worker, or it can increase variety and decisionmaking opportunities.

Management's strategies and motivations for introducing programmable automation are key in determining its impacts. In addition, the nature of

<sup>113</sup>Sara Kiesler, “The Hidden Messages in computer Networks,” *Harvard Business Review*, January/February, 1986. As Kiesler notes, whereas employees may take great care in composing paper memos accounting for their activities, they are much more inclined to send electronic mail messages in haste and without much reflection.

<sup>114</sup>*Ibid.*, p. 47.

<sup>115</sup>Mintzberg, *op. cit.*, footnote 112, pp. 130-131.

labor-management relations will affect the implementation of new technology and its consequences for the work environment<sup>116</sup>

For many who view the new technologies through the lens of an industrialized past, the primary value of communication technologies lies in their ability to reduce costs and to enhance control over operations. While such opportunities surely exist, an approach that is based solely on this perspective is likely to have the most detrimental impact on operators. It could lead, for example, not only to problems of deskilling and displacing workers, but also to increased monitoring of the work force.<sup>117</sup> Moreover, by adhering to such a perspective, businesses may forego other economic opportunities that, in the long run, may prove more productive. For as Paul Strassman has noted:

The sum of many efficient activities may not add up to an effective information service.<sup>118</sup>

Alternative views, which in no way demean the importance of efficiency, focus on the technology's ability to both restructure and enhance work relationships. According to Michael Piore and Charles Sabel, for example, because new technology allows business to carry out flexible manufacturing, many workers no longer need to be organized on assembly lines; rather, they will be able to work more in accordance with what, in the long run, is a more productive arrangement—that is, an arrangement based on craft principles.<sup>119</sup>

Similarly, from the perspective of Shoshana Zuboff, computer-mediated communication technologies need not be used to undermine or reduce job-related skills, as they have in the past; on the contrary, they can be used to “informat” the operator about the entire productive work process. As she describes it:

Action-centered skills . . . are built into the technology as it substitutes for bodily presence—that is automation. At the same time, activities are made transparent. They are exposed in detail as they are textualized in the conversion to explicit informa-

tion—that is informatting. In principle, the technological substitute for bodily presence frees the human being from having to participate in the immediate demands of action (and the lengthy investment in the associated skills). However, the technology not only frees individuals “from” but also frees them “to.” The automating capacity of the technology can free the human being for more comprehensive, explicit, systemic, and abstract knowledge of his or her work made possible by the technology's ability to informat.<sup>120</sup>

To be successful, such an approach would require investments in human beings as well as in technology. It would, moreover, entail risks for management; for a technology that “informat” is bound to diminish hierarchy. Posing this dilemma for management, one corporate vice-president reflected:

What has been managerial access to information is not as comfortable a notion as it may seem. There has been a fear of letting it out of our hands—that is why information is so carefully guarded. It could be misused or misinterpreted in a way that cannot be managed. Traditionally, we have thought that such data can only be managed by certain people with certain accountabilities and, I hesitate to say, endowed with certain skills or capabilities. But with the new technology it seems there is an almost inevitable kind of development if you have a goal of maximizing all business variables and maximizing the entire organization's ability to contribute to that effort. I don't think you can choose not to distribute information and authority in a new way if you want to achieve that. If you do, you will give up an important component of being competitive.<sup>121</sup>

## Line Managers

Like the CEO, line managers are responsible for executing the formal goals of the business corporation, and they, too, derive much of their authority from their position within the bureaucracy and the access to privileged information that this position affords. In contrast to top management, however, the line manager is concerned not only about the overall growth and survival of the firm, but also about

<sup>116</sup>U.S. Congress, Office of Technology Assessment, *Computerized Manufacturing Automation. Employment, Education, and the Workplace*, OTA-CIT-235 (Washington DC: U.S. Government Printing Office, 1985), p. 10.

<sup>117</sup>For an analysis of the issues involved in work monitoring, see U.S. Congress, Office of Technology Assessment, *The Electronic Supervisor: New Technologies, New Tensions*, OTA-CIT-333 (Washington DC: U.S. Government Printing Office, September 1987).

<sup>118</sup>Paul Strassman, T/w *Information Payoff: The Transformation of Work in the Electronic Age* (New York, NY: The Free Press, 1985), p.117.

<sup>119</sup>Piore and Sabel, op. cit., footnote 3.

<sup>120</sup>Zuboff, op. cit., footnote 5, p. 181.

<sup>121</sup>As quoted in *ibid.*, p. 289.



preserving his or her own particular department, or sector of responsibility, within the organization.

The widespread deployment of computer-based communication technology within the business corporation may undermine the line manager's position in a number of different ways. Many of the simpler functions that managers perform can be executed electronically, as we have seen with respect to both business operations and procurement activities.<sup>122</sup> Equally, if not more, threatening to the manager's position is the fact that electronic networks may replace him in his role as chief communicator.<sup>123</sup> Communication networks may also weaken the manager's control over his own domain, since one of the benefits of the new technologies is their ability to create flexible interdepartmental arrangements that can be constituted on an ad hoc basis for different tasks.

Not all prognoses of the manager's future role are so bleak, however. Paul Strassman, for example, argues that the business opportunities afforded by new communication technologies do not necessarily entail losses for middle management. In fact, he predicts that future organizations will need more, not fewer, managers.<sup>124</sup> In his scenario, however, the role of management will be completely overhauled. Instead of acting as coordinator and information intermediary, the future manager will devote him/herself to staff development, training, and guidance.<sup>125</sup> Similarly, Ralph H. Kilman, professor of business administration and director of the program on corporate culture at the Graduate School of Business, University of Pittsburgh, anticipates that the successful corporation of the future will be a network organization built around a hub of people and information, each acting on the other. Under these circumstances, each company:

... will have to nurture its own unique culture and

develop the quality of its human resources [since] competitive advantage will rest increasingly on the way each network organization gathers and accesses information, makes its decisions and then carries out those decisions.<sup>126</sup>

Reflecting some of these developments, we find, for example, that the General Motors parts plant in Bay City, MI, recently dismissed one-quarter of their middle managers. Characterizing the organizational changes that followed their dismissal, Patricia Carri-gan, plant manager, notes that:

[Before the cuts] the production manager. . . sort of stood over the factory and cracked the whip. Now, hourly workers are monitoring their own time, authorizing their own payroll and setting their own vacations . . . Some managers have had to change their style. '27

### Analysts of the Technostructure

The analysts of the technostructure include professionals such as planners, accountants, budget analysts, operation managers, and MIS analysts.<sup>128</sup> Although analysts have no bureaucratic authority of their own, they have influence in the firm, given their expertise. As a reflection of their professionalism, their primary goals are:

... professional excellence, perpetual but moderate and well-regulated change in the organization, ever increasing bureaucratization, and, as the criterion for choice, economic efficiency.<sup>129</sup>

As we move forward into a knowledge-based society, it is the analysts of the technostructure who have the most to gain from the organizational changes taking place within the business firm. According to Drucker, it is the knowledge worker who will replace the mid-level manager in the firm, giving rise to organizations that are much less

<sup>122</sup>See also Eliezeer Geisler, "Artificial Management and the Artificial Manager," *Business Horizons*, July/August 1986, pp. 17-21.

<sup>123</sup>Peter Drucker predicts, for example, that in future organizations "both the number of management levels and the number of managers can be sharply cut. The reason is straightforward: it turns out that whole layers of management neither make decisions nor lead. Instead their main, if not their only, function is to serve as 'relay s'--human boosters for the faint unfocused signals that pass for communication in the traditional pre-information organization." Peter Drucker, "The Coming of the New Organization," *Harvard Business Review*, January/February 1988, p. 45. For a discussion of how these changes are taking place, see Sally Lehrman, "Middle Managers Face Squeeze as Firms Try New Structures," *The Washington Post*, Sept. 4, 1988, p. H2.

<sup>124</sup>Strassman, *op. cit.*, footnote 118, pp. 196-199.

<sup>125</sup>*Ibid.*

<sup>126</sup>Ralph H. Kilman, "Tomorrow's Company Won't Have Walls," *The New York Times*, June 18, 1989, p. 3.

<sup>127</sup>Lehrman, *op. cit.*, footnote 123.

<sup>128</sup>Mintzberg, *op. cit.*, footnote 112, p. 136.

<sup>129</sup>*Ibid.*, p. 137.

hierarchical than they are today.<sup>130</sup> The technical analyst will also benefit from the increased opportunity for professional contact and collaboration that electronic networks provide.

One group of analysts that is playing an increasingly important role in business is the information systems managers.<sup>131</sup> Responsible for integrating and controlling corporations' distributed databases, the manager is becoming more and more involved with issues involving corporate strategy at the highest levels of management.<sup>132</sup>

### Support Staff

The support staff includes members of all groups who provide services in support of the basic operational function of a business firm. Including both skilled and unskilled workers, they range from cafeteria workers and secretaries to public relations specialists and legal counsels.<sup>133</sup> Because new communication technologies allow many of their services to be easily purchased outside of the corporation, members of the support staff are among the most vulnerable to technological change. Moreover, with a worldwide communication system, there is a much larger pool of potential workers to draw on, reducing the leverage of U.S. workers even more. In this situation, as in the case of operations workers, the unskilled are at the greatest disadvantage.

Given the growing importance of the service sector of the economy, one group that could suffer disproportionately from the widespread deployment of computer-based communication systems is office workers. A 1985 OTA study on office automation found, for example, that there will be a significant reduction in the hours associated with a given volume of information-handling. This will entail a reduction of jobs primarily in clerical/support occupations, but also in low-level supervisory or man-

agement jobs.<sup>134</sup> Moreover, because women and minority groups are disproportionately represented in these kinds of jobs, they are likely to be affected most. For those who retain their jobs, automation may have more beneficial effects, reducing the more trivial aspects of work and requiring workers to acquire broader, more process-oriented skills.<sup>135</sup>

Communication technologies will also allow workers more freedom and flexibility in determining the time and location of their work. Much office work, for example, can be done in the home using an electronic network. The work-at-home option is not without controversy, however. To date, there have been a number of failed experiments, which illustrate some of the problems that might arise.<sup>136</sup> Many fear that working at home may create a growing pool of contingent workers who will have neither job security nor benefits.<sup>137</sup> Moreover, trade unionists have pointed out that an increase in the supply of contingent labor will depress the wage rates and reduce the bargaining power of the full-time employed.

### *Roles and Relationships in Market Activities*

Exchange activities entail the transfer of goods and services, either as inputs or outputs of production. In capitalist societies these activities are regulated by the mechanism of the market. Thus, to understand the roles and relationships involved in such exchanges, it is necessary to begin by looking at the dynamics of the marketplace.

In the most general sense, the market is the entire web of interrelationships that comes into play in the buying and selling of products.<sup>138</sup> For a market to exist and for an exchange to take place, two roles are essential: those of the producer and consumer. More often than not, however, other players perform the role of intermediaries, facilitating the exchange.

<sup>130</sup>Drucker, op. cit., footnote 123.

<sup>131</sup>R. Orazine, "Why MIS Managers are Becoming Network Experts," *Telecommunications*, January 1988, pp. 103-104.

<sup>132</sup>Ibid. See also Rockart, op. cit., footnote 90.

<sup>133</sup>Mintzberg, op. cit., footnote 112, p. 137.

<sup>134</sup>U.S. Congress, Office of Technology Assessment, *Automation of America's Offices*, OTA-CIT-287 (Springfield, VA: National Technical Information Service, 1985), p. 15.

<sup>135</sup>Ibid.

<sup>136</sup>For a discussion, see Barbara Tzivani Behnam, "There Is No Place Like Home," *Best's Review*, May 1988, pp. 33-38.

<sup>137</sup>Richard S. Belous, The Conference Board, "The Telecommunications Industry, Contingent Workers, and the House of Labor," paper presented at The George Washington University Conference on Telecommunications: An American Industry Under International Pressure, Airlie, VA, May 9, 1988.

<sup>138</sup>Steiner, op. cit., footnote 11, p. 575.

Intermediaries include, for example, wholesalers, retailers, advertisers, and media-owners.

In contrast to a business organization in which roles are hierarchically structured and relatively stable, the relationships in a market are dynamic, changing in accordance with the specific set of circumstances in which economic actors come together. These circumstances can be classified as those of monopoly, oligopoly, competition, or monopsony, depending on five basic forces:

- . threat of entry by new firms,
- threat of substitution,
- . bargaining power of buyers,
- . bargaining power of suppliers, and
- the rivalry among current competitors.<sup>139</sup>

The structure of the market, and hence the relationships between producers and consumers, can be significantly altered by the introduction of new technologies. The deployment of a new technology may give rise to significant economies of scale and scope, providing a producer with a quasi-natural monopoly. Thus the mom-and-pop electronic stores that set up community antennas in areas where broadcast television reception was poor enjoyed near-monopoly status in their markets. On the other hand, new technologies can also undermine an existing monopoly; for example, VCRs, MMDS, and direct broadcast satellites (DBS) may have this effect on cable television's monopoly on delivery of commercial-free movies to the home.

### Consumers

To make "optimal" buying decisions—and hence to maximize their leverage vis a vis producers—consumers require perfect information about products and their costs. However, they generally depend on producers and retailers for the information they need to make purchases. Such information, which is designed primarily to promote sales, is often incomplete and biased. The search costs of obtaining accurate information about all competing products, in terms of time and travel costs, are often so high that consumers rarely pursue such searches. Instead, they accept a choice that is satisfactory but suboptimal.

New technologies can greatly reduce the consumer's information and transaction costs.<sup>140</sup> By

making it possible for producers and retailers to deliver large amounts of commercial information directly to the home or office, new communication technologies may benefit consumers in a number of different ways. These include allowing them to make purchases without traveling; helping them to locate the specific products they want; providing them with more timely, and more perfect, comparative information about their choices; and facilitating the ordering process.

The new technologies will also reduce the consumer's dependence on traditional intermediaries, such as advertisers and retailers. At the same time, however, the consumer will become more dependent on the media companies that control the new pipelines through which commercial information flows.

The kinds of benefits that the consumer derives from the new technologies will depend on several factors. Incompatibility may limit their usefulness. Moreover, the cost and complexity of equipment and services may limit their availability. Those without the technology could suffer badly, if exits from the traditional retailer market led to increased travel time, decreased service, and higher prices based on lower volumes. In addition, all consumers may be worse off, to the extent that the cost of the service exceeds previous travel and transaction costs.

Consumers may also have mixed feelings about unsolicited advertisements. Some may find them valuable as sources of commercial information, and some may find them entertaining. Others, however, will find unsolicited commercial messages intrusive. Those most offended by this kind of advertising can, to some extent, evade it by using technologies such as the remote control devices for TVs and VCRs and telephone services such as Customer Local Area Signaling Service (CLASS). CLASS indicates whether or not incoming calls are from numbers the customer has previously stored in a computer

Consumers may also have concerns about their rights to privacy and the data that are collected as a result of their economic transactions. On the other hand, some may be concerned if data about them are not collected and stored, in that they might, as a

<sup>139</sup>Porter, *op. cit.*, footnote 57, ch. 1.

<sup>140</sup>For a more detailed account of the opportunities for consumers, see ch. 8.

result, be excluded from certain economic opportunities. 141

## Producers

The new technologies will provide producers with more pathways to access consumers directly, substantially reducing their dependence on retailers and perhaps even advertisers. These technologies will, moreover, help producers to collect, store, and analyze market data in a much more cost-effective way. To the extent that the delivery of tangible items is facilitated by communication technologies, it will be easier for producers to promote teleshopping.

At the same time, however, producers may experience much greater competition. Consumers will have much more information, and markets will be much broader in geographic scope.

To defend against consumer cost comparisons, producers might use incompatible catalog systems, as a number of them are presently doing in the area of business-to-business sales.<sup>142</sup> If pursued to considerable success, however, such a strategy might come into conflict with antitrust law as it is embodied in the “essential facilities doctrine.”

## Intermediaries

Local retailers manage the forums through which a considerable amount of product information passes. One of their key functions in the exchange process is a selective one. Because the space used to display products is not without costs, retailers must choose carefully what they sell. Thus, they reduce the range of products available to consumers. As intermediaries, however, they are dependent on both producers and consumers. Their success depends on their ability to both attract the right products and correctly anticipate consumer needs.

With the development of electronic shopping centers and malls, local retailers will face much greater competition both in terms of the number of their competitors as well as prices. Their ability to succeed will depend on the popularity of electronic

shopping, the extent to which they can reduce costs, and/or their ability to differentiate their products and enhance the value of traditional shopping. For example, retailers might use their knowledge of market demand to select the most likely big sellers and secure cost-justified volume discounts from producers. Or they might offer enhanced services such as an entertaining environment or salespeople with special expertise.

Large, national retailers that collect transactional data-like credit-card and telephone companies, banks, and airlines-and local retailers employing scanning technologies will gain market power by virtue of their data. Producers and retailers wanting that data will become more dependent on these retailers, and, to the extent that laws of privacy and property permit, they may seek greater access to it either by sale, joint agreement and joint ventures, or by acquisition. Access to this kind of data can constitute significant barriers to entry.

Owners of real estate used by retailers have also played an intermediary role in the process of making and executing purchasing decisions. They serve as a physical “pipeline” through which product information passes. In much the same way as the retailers, owners of shopping centers are vulnerable to the development of electronic shopping.

The new technologies are significantly decreasing the dependence of producers, retailers, and advertising agencies on the traditionally dominant *communication media* such as newspapers, television, radio, and magazines. As new communication media such as VCRs and tapes, videotex, and cable television gain larger audiences, the traditional media will lose a share of the total. Similarly, as improvements in the use of market research data permit personalized contacts via the mails and electronic media, and the use of desktop publishing and automatic-dialer and recorded-message players become more economical, the position of the traditional media will deteriorate even further.

<sup>141</sup>For a discussion of how this kind of economic segmentation might reinforce class segmentation, see Terry Curtis, “The Information Society: A Computer-Generated Class System?” Vincent Mosco and Janet Wasko (eds.), *The Political Economy of Information* (Madison, WI: University of Wisconsin Press, 1988), ch. 5.

<sup>142</sup>For example, one of most important reasons why McKesson Drug and the airlines established their purchasing systems was to cement their relationships with their buyers. If these proprietary systems are economically impractical to duplicate, and yet are essential to effective participation in a market, then competitors would have a legal right to reasonable access under the “essential facilities doctrine.” This doctrine prohibits firms with monopoly control over an essential facility from using this control, without a legitimate business reason, to foreclose competition in a market in which they participate. For a discussion, see Peter Marx, “The Legal Risks of Using Information as a Competitive Weapon,” *International Computer Law Advisor*, vol. 2, No. 5, February 1988, pp. 18-24.

The electronic media will also be favored over **traditional** media to the extent that consumers shop on electronic networks rather than by traveling to stores. Since those who supply storage and transmission will have so much to gain, there is likely to be greatly increased competition between existing cable and telephone companies for the right to provide these services. Such traffic will allow suppliers to collect and compile valuable marketing research data.

*Advertisers* have traditionally helped producers to identify the most likely buyers, create presentations to attract them, and identify the most efficient media for sending these messages. To the extent that producers use new technologies to execute these functions and to link themselves directly to consumers, advertiser may be displaced.

As already mentioned, new technologies also allow consumers to evade advertising. The loss of television audience resulting from consumers using remote control devices for zipping, zapping, and flipping is still being investigated, but advertisers have expressed considerable concern.<sup>143</sup> One approach they might adopt is to produce short mini-ads that are difficult to zap, or ads that are incorporated into entertainment programs. Absent an effective strategy, advertisers may be unwilling to pay the media as much for delivering audiences, and producers may be induced to deal directly with consumers.

Another intermediary to be affected is that of *delivery services*. This area will experience increased demand if more buyers use communication technologies to make purchase decisions and place orders, rather than traveling to retailers.

## KEY FACTORS AFFECTING OUTCOMES

Notwithstanding the numerous business opportunities that new communication technologies afford and the extensive publicity they have received, most corporations have been slow to adopt these new technologies, or to employ them in strategic ways. Instead of viewing the new technologies as a way of rethinking and restructuring their activities, most

firms still regard technology primarily as a means of reducing costs and expanding markets.<sup>144</sup> Not surprisingly, large companies that can afford to develop their own networks, as well as service companies whose primary activities entail data-processing and data exchange, are the most advanced and sophisticated in their use of communication and information technologies.<sup>145</sup> As Margie Semilof has described the situation:

When it comes to communications, the country's largest users vary widely in levels of expertise.

For example, there's the fortunate few who aren't on the same technological learning curve as the rest, because their business is in computers and/or communications. This group includes IBM, AT&T, Digital Equipment Corp., Hewlett-Packard Co., Unisys Corp., and the regional Bell holding companies.

A second class is comprised of stellar users—companies with strong engineering departments that for years have been using communications to solve their business problems. This group includes such well known technology leaders as General Dynamics Corp: Eastman Kodak Co.; Ford Motor Co.: and Sears, Roebuck and Co.

But many Fortune 100 companies have no in-house expertise and—as does the rest of the user community—rely on pluck and luck to solve their networking problems. This class of users, analysts say, typically lags about three to five years behind the rest of the Fortune-sized pack. These companies generally develop other aspects of their businesses.<sup>146</sup>

The full impact of new technologies in the business arena will depend on how and under what circumstances they are deployed. Just as these technologies give rise to benefits, so they may also create a number of new social problems for policymakers. These problems can be summarized as:

- worker displacement and retraining, a problem that will no longer be confined to the lower levels of the employment scale, but will extend to the realm of management as well;
- defining the privacy rights of individuals in an environment-in which information about individuals can be easily compiled and distributed,

<sup>143</sup>These actions have been referred to as "video grazing." For a discussion, see Peter Ainslie, "Confronting a Nation of Grazers," *Channels*, September 1988, pp. S4-62; and "Zapping the TV Networks," *US News and World Report*, June 1, 1987, p. 56.

<sup>144</sup>Stephen Boyd, "Telecom's Quest," *CommunicationsWeek*, CLOSEUP, Feb. 29, 1988, PP. 14-15 -

<sup>145</sup>*Datamation*, Sept. 1, 1987, p. 47.

<sup>146</sup>Margie Semilof, "Communication Gap," *CommunicationsWeek*, CLOSEUP, June 13, 1988, p. C9.

and in which the value of personal data has a high market value;

- equity for small businesses, given the growing strategic value of communication systems in the business arena, and the economies of scale entailed in developing, deploying, and operating such systems; and
- maintaining and modernizing the public communication infrastructure, as more and more businesses find it to their advantage to develop their own communication networks as part of their competitive strategies.

OTA identified a number of key factors that, over the long run, will determine whether or not, how, and with what effects U.S. businesses will exploit the opportunities afforded by new technologies. These include:

- the compatibility and interconnectivity of information systems,
- the laws concerning the use of information,
- economic and technical resources,
- corporate culture and organizational structure,
- developments in international trade and international telecommunication regulation,
- domestic regulatory policies, and
- the availability of a skilled work force.

### *Compatibility and Interconnectivity of Information Systems*

Electronic mail, local- and wide-area networks, programmable manufacturing, and relational databases all require interconnection. Hence, one of the most significant factors determining whether businesses can take advantage of new communication technologies is the degree to which the various systems being developed and used by businesses can communicate effectively with one another. Thus, as depicted in table 5-3, we see that in a recent survey of large-business users the lack of standards was cited as the most critical factor inhibiting the strategic deployment of new communication technologies. <sup>147</sup>

**Table 5-3—Main Obstacles to Effective and Strategic Use of Internetworking**

	Percentage of respondents mentioning problem
<b>Obstacles</b>	
Lack of unifying standards . . . . .	90.1
Vendors' inadequate understanding of users' needs . . . . .	83.5
Service limitations . . . . .	82.6
Product limitations . . . . .	82.2
Total Responding: 568	

NOTE: No other "obstacle" was mentioned by more than half the survey respondents.

SOURCE: *CommunicationsWeek's* Fifth Annual Communications Managers Survey, *CommunicationsWeek*, CLOSEUP, Sept. 12, 1988, p. C1 O. Copyright 1986 by CMP Publications, Inc., 600 Community Drive, Manhasset, NY 11030. Reprinted from *CommunicationsWeek* with permission.

To obtain the kind of communication required by business will necessitate more than simple physical interconnection; it will:

. . . require the logical interconnection of a corporation's dispersed information processing assets—hardware, systems software, user applications and data bases. <sup>148</sup>

With this kind of connection, users will find it easy to negotiate their way through the entire corporate communication system—which will appear to be a single, integrated whole—accessing a wide array of resources and data. <sup>149</sup>

Perhaps the most important reason why many businesses have been unable to achieve this state of interconnectivity is the lack of some key technical standards. A number of these standards, such as those for Open Systems Interconnection (OSI) and Integrated Services Digital Networks (ISDN), are now being negotiated in international standards-making fora. Other more or less de facto standards, such as IBM SNA, are evolving in the marketplace. <sup>150</sup> However, because standards significantly affect competitive relationships, the process of establishing them can be long and contentious. Thus, a number of gaps in the area of technical standards still exist, some of the most critical of which are:

<sup>147</sup>For a discussion, see Steven Titch, Margie Semilof, and John Berrigan, "Missing Links," *CommunicationsWeek*, CLOSEUP, Sept. 12, 1988, pp. C6-C7; and Christine Bonafield and Paul Korzeniowski, "Neither Standards, Nor Understanding," *CommunicationsWeek*, CLOSEUP, Sept. 12, 1988, pp. C10-C11.

<sup>148</sup>Larry DeBoever, "Trek Toward Connection," *Computerworld*, Nov. 16, 1987, pp. S1S13.

<sup>149</sup>*Ibid.*

<sup>150</sup>*Ibid.*, p. S2.

- protocols supporting cooperative processing applications in peer relationships;
- standards for local area networks, which to date are still relatively immature;
- broadband ISDN standards;
- network management standards;
- document interchange standards; and
- standards for electronic data interchange.<sup>151</sup>

This issue of network interoperability affects not only the realm of business, but also all other realms of communication. It is analyzed in depth in chapter 11.

### ***Legal Framework for Employing Information in the Business Environment***

Just as a commercial and legal infrastructure was required in the 19th century for businesses to exploit the economic advantages afforded by the railroad and the telegraph, so too will new information laws be required if corporations are to employ information and communication technologies as part of their competitive strategies. As Peter Marx has noted, the use of new technologies for business gives rise to considerable legal uncertainty, since:

... the legal system has yet to generate a body of law capable of resolving the legion of questions posed by information--questions that have only recently surfaced as user capabilities, expectations, and use of information and information technologies have dramatically changed.<sup>152</sup>

One major area of uncertainty is that of privacy law. When Congress passed the Privacy Act in 1974, it declined to include the private sector within its provisions.<sup>153</sup> With more and more businesses seeking to package and distribute transactional data, the pressure to extend to corporations the rules regulating government's use of personal data, or to create new rules, is likely to mount.<sup>154</sup>

Another gap in information law relates to product liability and the negligent use of information. The courts will need to determine, for example:

- Who has rights to damages incurred because of inaccurate information?
- What responsibility does a corporate-user have to ensure the reliability and accuracy of the data that it uses, even when they are supplied by someone else?
- When should information be classified as a service and when as a product? and
- Should the standard of liability be negligence, and or might strict liability apply?<sup>155</sup>

Other areas that are likely to require legal attention include antitrust law, tax law, intellectual property law, as well as laws governing electronic filings for regulatory purposes. In a global economy, moreover, these gaps will need to be filled in, not only with respect to domestic law, but also, and increasingly, with respect to international law as well.

### ***Economic and Technical Resources***

Whether or not businesses will be able to make strategic use of new technologies will also depend on the extent of their financial and organizational resources. One D3 circuit, for example, which provides a transmission pipeline that operates at the rate of 45 megabits-per-second, costs approximately \$1 million per year. Thus, the costs of operating a large-scale telecommunication system can be great. It has been estimated, for example, that the annual expenditures of the top 100 communication users range from between \$1 billion at the top of the list to about \$20 million at the bottom, with the average expenditure falling between \$50 million and \$100 million.<sup>156</sup> Moreover, as can be seen in figure 5-4, by 1993, telecommunication expenditures are likely to constitute approximately 10 percent of the Fortune

<sup>151</sup>Ibid., pp. S9-S10.

<sup>152</sup>Marx, op. Cit., footnote 142, p. 19.

<sup>153</sup>The Privacy Act of 1974 was designed to address the tension between the individual's interest in personal information and the Federal Government's collection and use of that information. For a discussion, see U.S. Congress, Office of Technology Assessment, *Federal Government Information Technology: Electronic Record Systems and Individual Privacy, OTA-CIT-296* (Springfield, VA: National Technical Information Service, June 1986). See also Deborah G. Johnson and John W. Snapper, *Ethical issues in the Use of Computers* (Belmont, CA: Belmont Publishing Co.), part 3.

<sup>154</sup>In an effort to forestall such an occurrence, some companies, such as Warner-Amex, have worked toward developing voluntary standards with which businesses might comply.

<sup>155</sup>Marx, op. cit., footnote 142. See also Johnson and Snapper, op. cit., footnote 153; and Jaap H. Spoor, "Database Liability: Some General Remarks," *International Computer Law Adviser*, vol. 3, No. 7, April 1989, pp. 4-9.

<sup>156</sup>Jim Foley, "Our First Look at the Top 100 Communication Users," *CommunicationsWeek*, CLOSEUP, May 1, 1989, p. C3.

1000 companies' budgets, up from 8 percent today.<sup>157</sup>

Given such costs, it is clear why it has been primarily the largest companies that have made the greatest use of the new communication technologies.<sup>158</sup> As can be seen in table 5-4, all of the top 50 telecommunication-users in the United States earn annual revenues of more than \$3 billion. In this context, it is clear why a number of companies, citing cost as well as the lack of technical expertise as the reason for their decisions, have given up their efforts to deploy and operate their own private communication networks.<sup>159</sup>

Large businesses have a number of advantages over small companies in deploying new technologies. By buying in much greater quantities, they are often able to negotiate higher-quality service and lower prices either from the traditional telephone companies or from others. As the Chief Executive Officer of one network management company has noted:

Here is where large companies and their fat contracts have two key advantages over a smaller user. Small companies are often stuck with buying vendor vanilla. Nothing can set them apart from the competition, strategically. Large companies, however, can do some substantial tailoring, which can give them an edge. This is a distinct reversal of the concept that says smaller companies can be more innovative than big companies.<sup>160</sup>

The same is true with respect to gaining access to market data and strategic information. Large conglomerates, which are able to aggregate multiple data sets from multiple sources, are better off than smaller firms. If, as in the past, new communication technologies increase the minimum efficient scale of operations generally, the large multinational enterprise may have the most to gain. Large users also have more clout than smaller companies in negotiating standards.

Small manufacturers, moreover, are confronted by a number of problems that are unique to them. For

**Figure 5-4-Spending for Communications by Large Users, 1983-1993 Comparison (Percent of Total Operating Budget)**

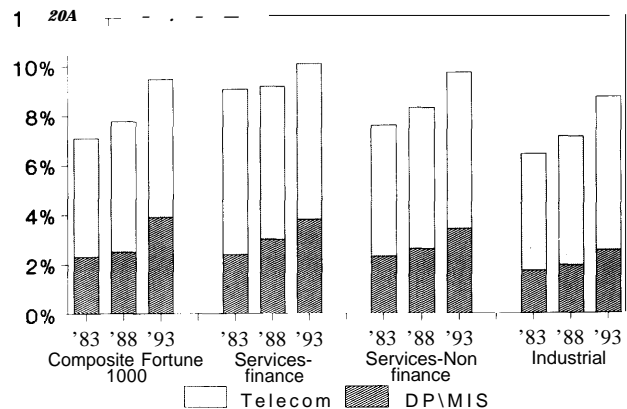

SOURCE: Copyright 1989 by CMP Publications, Inc., 600 Community Drive, Mahanassett, NY 10030. Reprinted from *CommunicationsWeek* with permission.

example, it is much harder for them to obtain financing for new technologies. And while large manufacturers may be able to absorb the cost of \$70,000 for computerized tools, it is much more difficult for any of the 200,000 small manufacturers in the United States who view \$10,000 as a major investment. Even more important is the fact that small companies rarely have the know-how required to take full advantage of the new technologies.<sup>161</sup>

### Corporate Culture and Organizational Structure

Existing corporate culture and organizational structure may also inhibit the use of communication technologies for strategic advantage.<sup>162</sup> For, as Howard Anderson of the Yankee Group has noted, the strategic use of telecommunications is:

... not a hardware issue; it is a mind-set issue. The communications user today has a wide range of technical options from which to choose solutions. The problem is that there is a pattern of corporate behavior based on repeating certain established ways of doing things that can be a real impediment to

<sup>157</sup>Candee Wilde, "Analysts See Happy New Year: Budgets Up," *CommunicationsWeek*, Jan. 2, 1989, pp. 1, 29.

<sup>158</sup>Peter Cowhey, "The Globalization of Telephone Pricing and Service," *Telecommunications*, January 1988, p. 30. See also Semilof, *op. cit.*, footnote 55, pp. C6-C8.

<sup>159</sup>For a discussion, see John Foley, "Problems Force Users to Retrench," *CommunicationsWeek*, Nov. 7, 1988, pp. 1, 62; and John Foley, "Merrill Shifts Gears; Solicits Network Bids," *CommunicationsWeek*, Oct. 31, 1988, pp. 1, 55.

<sup>160</sup>Semilof, *op. cit.*, footnote 146, p. C13-C14.

<sup>161</sup>Kochen, *op. cit.*, footnote 67; see also Kirk Victor, "Help Wanted, Badly," *National Journal*, Mar. 25, 1989, pp. 730-734.

<sup>162</sup>See Clinton Wilder, "Corporate Culture Is Key to IS Success," *Computerworld*, May 22, 1989, p. 61.



Table 5-4-Top 50 U.S. Communication Users

Rank	Company	Primary business	Employees (in thousands)	Revenues (\$billions)
1.	General Motors Corp., Detroit, MI	Automotive	813	101.78
2.	General Electric Co., Fairfield, CT	Manufacturing	302	40.52
3.	Citicorp/Citibank N.A., New York, NY	Banking	90	119.56
4.	IBM, Armonk, NY	Computer	389	54.22
5.	American Express Co., New York, NY	Finance	84	17.77
6.	Westinghouse Electric Corp., Pittsburgh, PA	Manufacturing	112	10.68
7.	McDonnell Douglas Corp., St. Louis, MO	Aerospace	112	13.34
8.	Sears Roebuck and Co., Chicago, IL	Retail	500	48.44
9.	Ford Motor Co., Dearborn, MI	Automotive	350	71.64
10.	Boeing Co., Seattle, WA	Aerospace	136	15.36
11.	Rockwell International Corp., El Segundo, CA	Manufacturing	116	12.12
12.	Prudential Insurance Co. of America, Newark, NJ	Insurance	66	14.05
13.	Lockheed Corp., Calabasas, CA	Aerospace	99	11.32
14.	Xerox Corp., Stamford, CT	Manufacturing	99	15.13
15.	United Technologies Corp., Hartford, CT	Manufacturing	190	17.17
16.	ITT Corp., New York, NY	Manufacturing	120	19.53
17.	Unisys Corp., Blue Bell, PA	Computer	93	9.71
18.	Union Carbide Corp., Danbury, CT	Manufacturing	43	6.91
19.	Texas Air Corp., Houston, TX	Airline	70	8.48
20.	United Parcel Service of America Inc., Greenwich, CT	Transportation	192	9.68
21.	BankAmerica Corp., San Francisco, CA	Banking	65	76.29
22.	E.I. du Pont de Nemours & Co., Wilmington, DE	Manufacturing	140	30.47
23.	Raytheon Co., Lexington, MA	Manufacturing	77	7.66
24.	Allied Signal Inc., Morristown, NJ	Manufacturing	115	11.12
25.	Caterpillar Inc., Peoria, IL	Manufacturing	54	8.18
26.	Chase Manhattan Corp., New York, NY	Banking	42	68.58
27.	J.P. Morgan & Co. Inc., New York, NY	Banking	164	3.99
28.	General Dynamics Corp., St. Louis, MO	Aerospace	105	9.34
29.	Chrysler Corp., Highland Park, MI	Automotive	141	26.28
30.	USX Corp., Pittsburgh, PA	Manufacturing	54	13.90
31.	First Interstate Bancorp., Los Angeles, CA	Banking	36	37.57
32.	Honeywell Inc., Minneapolis, MN	Manufacturing	79	6.68
33.	Digital Equipment Corp., Maynard, MA	Computer	111	9.39
34.	AMR Corp., Dallas/Ft. Worth, TX	Airline	65	7.20
35.	Eastman Kodak Co., Rochester, NY	Manufacturing	124	13.31
36.	J.C. Penney Co. Inc., Dallas, TX	Retail	181	15.33
37.	Pepsico Inc., Purchase, NY	Manufacturing	225	11.49
38.	Metropolitan Life Insurance Co., New York, NY	Insurance	36	13.96
39.	Chemical New York Corp., New York, NY	Banking	29	55.51
40.	Amoco Corp., Chicago, IL	Oil	47	20.17
41.	May Department Stores Co., St. Louis, MO	Retail	143	10.31
42.	Minnesota Mining & Mfg. Co. (3M), St. Paul, MN	Manufacturing	82	9.43
43.	Merrill Lynch & Co. Inc., New York, NY	Finance	43	10.87
44.	Texaco Inc., White Plains, NY	Oil	50	34.37
45.	Cigna Corp., Philadelphia, PA	Insurance	48	16.91
46.	UAL Corp., Chicago, IL	Airline	66	8.29
47.	Federal Express Corp., Memphis, TN	Transportation	41	3.20
48.	R.H. Macy & Co. Inc., New York, NY	Retail	54	5.21
49.	First Union Corp., Charlotte, NC	Banking	20	17.43
50.	Mobil Corp., New York, NY	Oil	121	56.72

SOURCE: Copyright 1969 by CMP Publications, Inc., 600 community Drive, Manhasset, NY 11030. Reprinted from *CommunicationsWeek* with permission.

using technology to solve, not aggravate, business problems.<sup>163</sup>

Explaining why U.S. managers have had difficulties reaping the advantages of new technologies, Robert Hayes and Ramchandran Jaikumar echo this same point of view. They note:

For years, manufacturers have acquired new equipment much in the way a family buys a new car. Drive out the old, drive in the new, enjoy the faster, smoother, more economical ride-and go on with life as before. With the *new* technology, however, "as before" can mean disaster. Executives are discovering that acquiring an FMS [flexible manufacturing system] or any other advanced manufacturing system is more like replacing that old car with a helicopter.<sup>164</sup>

All too often, senior managers tend to view communication technologies merely as operational tools, or as a means for improving productivity.<sup>165</sup> The tendency to see technology from this narrow perspective stems in part from budgetary practices that look for benefits within a 2-year payback period.<sup>166</sup> Organizational resistance to deploying new technologies may also emerge as traditional titles and roles are redefined, skill-mix requirements are broadened, and the traditional bases for measuring performance are reevaluated.<sup>167</sup> As Anderson has pointed out, in the future, communication managers are going to have to become chief network officers, and as such they will need to have a much greater grasp of basic business objectives.<sup>168</sup>

Compounding the problems of organizational adjustment is the fact that taking advantage of new technologies will require interorganizational as well

as intraorganizational changes. Turf problems are likely to emerge insofar as technological developments serve to favor some jobs over others. For example, one group that has benefited from the enhanced role of information and communication in business is the management information systems (MIS) manager. As one industry observer describes:

The 1980s are seeing the rise of a new breed of computer managers. The new MIS managers capitalize on the mystery surrounding the computer as an advantage to maintain their positions. The new MIS managers are more expansionist; they are more willing to take risks than their data processing predecessors.

These managers have also discovered a new and powerful tool to further their positioning-the local area network.<sup>169</sup>

### *International Trade and Foreign Communication Policies*

Foreign trade policies and the telecommunication policies adopted in other countries will also be a factor determining the extent to which U.S. businesses can take advantage of the global opportunities presented by new communication technologies.<sup>170</sup> As described in chapter 12, many countries throughout the world are, like the United States, reevaluating the strategic role of communication in their societies and, in that light, their telecommunication policies as well. One change that is likely to have a significant impact will be the development of a single European market by the year 1992.<sup>171</sup>

Depending heavily on their own private networks, many international business-users have a considera-

1@ Howard Anderson, "Using Telecommunications Strategically," *Telecommunications*, January 1989, p. 41.

163 Howard Anderson, "Using Telecommunications Strategically," *Telecommunications*, January 1989, p. 41.

164 Robert H. Hayes and Ramchandran Jaikumar, "Manufacturing's Crisis: New Technologies, Obsolete Organizations," *Harvard Business Review*, September/October 1988, pp. 77-85.

165 John Poulos and Fritz Ringling, "Communications As a Strategy Tool," *CommunicationsWeek*, Feb. 29, 1988, p. 6; see also Michael L. Sullivan-Trainer, "The Push for Proof of Information Systems Payoff," *Computerworld*, Apr. 3, 1989, pp. 55-57; and Stephen Boyd, "Telecom's Quest," *CommunicationsWeek*, CLOSEUP, Feb. 29, 1988, pp. 14-15.

166 Boyd, op. cit., footnote 165, p. 50.

167 John Poulos and Fritz Ringling, "Seeking an Organizational Fit," *CommunicationsWeek*, CLOSEUP, Feb. 29, 1988, p. 18.

168 Anderson, op. cit., footnote 163, p. 42.

169 Orazine, op. cit., footnote 131.

170 For one discussion, see Leland L. Johnson, "International Telecommunications Regulation," Paula R. Newberg (ed.), *New Directions in Telecommunications Policy*, vol. 1, *Regulatory Policy: Telephony and Mass Media* (Durham, NC: Duke University Press, 1989), pp. 92-122.

IT 1 For one discussion, see Henry Goldberg, "A U.S. Observer's View of the Green Paper," *Telematics*, May 1988, pp. 1-8; see also Oswald H. Ganley, *International Communications and Information in the 1990s: Forces and Trends*, Program on Information Resources Policy, Center for Information Policy Research, Harvard University, Cambridge, MA, 1988; and N.P. Costello, "The Green Paper and the Regulatory Environment," *International Computer Law Adviser*, vol. 3, No. 6, March 1989, pp. 13-18.

ble stake in the outcome of these international developments.<sup>172</sup> Ideally, these big users would like to have access to these dynamic markets and be able to configure their networks on an international basis to suit their own particular needs. To achieve this they will need to have the freedom, for example, to create their own mixture of synchronous and asynchronous data traveling at different speeds, using the best codes and protocols.<sup>173</sup> Moreover, American businesses want to be able to freely choose their customer-apparatus and value-added network services, and to have access to the public network when their own systems are overloaded. Under present circumstances, it is unlawful in many countries to exercise such freedom.<sup>174</sup> As one industry observer has noted:

... there's almost no end to the interference by European governments. Private microwave networks, which are all but taken for granted in the U. S., are virtually outlawed all over Europe. Satellite networks are O.K.—if you use the PTT's equipment and let the International Telecommunications Satellite Organization (Intelsat), which is jointly owned by the U.S. and 113 countries, perform the transmission . . .

In the meantime, it can take years just to get approval from a government phone authority such as the Deutsche Bundespost to hook equipment such as modems or data multiplexer to the public network.<sup>175</sup>

American businesses will also be affected by international trade and communication policies. These rules and regulations are now being negotiated in a number of international fora such as the General Agreement on Tariffs and Trade (GATT),<sup>176</sup> the International Telegraph and Telephone Consultative Committee (CCITT),<sup>177</sup> and the World Administrative Telephone and Telegraph Confer-

ence (WATTC). One event that bodes well for American business, for example, was the recent meeting of WATTC in Melbourne, Australia, whose purpose was to establish new rules for international telecommunication. After intense negotiations among the participants, a compromise was reached that—while allowing foreign telecommunication administrations to continue to authorize international services offered to the public—also permits private network operators to be exempted from all coverage through special arrangements.<sup>178</sup>

### *Domestic Communication Regulatory Policies*

Domestic communication regulatory policies affect business users in many ways. Pricing decisions, for example, will affect not only the costs of purchasing services, but also decisions about whether or not to establish a private telecommunication network. Regulatory decisions about tax policies, depreciation rates, and R&D support will affect the rate of modernization within the public communication infrastructure, and hence the availability of advanced services for small as well as large businesses. These and similar kinds of issues are discussed and analyzed in detail in chapters 9 through 13.

### *Human Resources*

Whether or not U.S. businesses will be able to fully exploit the numerous opportunities that communication technologies now afford will depend, in the final analysis, on the quality of its work force. As many labor analysts have noted, skill requirements in a knowledge-based or information society will be much higher than ever before. At the present time, it would appear that the prospects for meeting these

<sup>172</sup>For a discussion, see John Foley, "Border Crossings," *CommunicationsWeek*, CLOSEUP, Aug. 29, 1988, pP. C3-C5.

<sup>173</sup>George McKendrick, "International Telecom Users Seek the Tools to Address Their Special Needs and Problems," *CommunicationsWeek*, May 16, 1988, p. 21.

<sup>174</sup>*Ibid.* For example, at present, the CCITT D-series recommendations on the use of international leased circuits are very restrictive, preventing the competitive provision of many services. For a discussion, see John J. Keller, "A Scramble for Global Networks," *Business Week*, Mar. 21, 1988, pp. 140-148.

<sup>175</sup>*Ibid.*, pp. 143, 146.

<sup>176</sup>GATT is presently moving ahead to develop a draft agreement on trade in services. For such an agreement to actually materialize, however, may require a substantial revision of existing national and international regulatory practices. One question that negotiators will have to wrestle with, for example, is which services and facilities might reasonably be designated national monopolies. See Graham Finnie, "GATT Moves Center Stage," *Telecommunications*, March 1989, p. 11.

<sup>177</sup>See Graham Finnie, "Which Way Next for the CCITT?" *Telecommunications*, November 1988, pp. 77-79.

<sup>178</sup>G. Russell Pipe, "WATTC Agrees on New Telecom Rules," *Telecommunications*, January 1989, pp. 19-20. See also Michael Nugent, "WATTC-88: Global Harmonization, or Entirely New International Law," *Telematics*, February 1988, pp. 1-6; Graham Finnie, "The World According to WATTC," *Telecommunications*, November 1988, pp. 73, 88; and Parker W. Borg, "On the Eve of WATTC—the U.S. View," *International Computer Law Adviser*, November 1988, vol. 3, No. 2, pp. 11-14.

requirements are quite slim.<sup>179</sup> In a recent study of young adults, the National Assessment of Educational Progress (NAEP) found, for example, that while most of those surveyed were not illiterate neither were they literate,<sup>180</sup> in that they were not equipped to handle complex tasks. According to NAEP's findings:

The overwhelming majority of America's young adults are able to use printed information to accomplish many tasks that are either routine or uncomplicated. It is distressing, however, that relatively small proportions of young adults are estimated to be proficient at levels characterized by the more moderate or relatively complex tasks.<sup>181</sup>

Looking specifically at the match between jobs and skill levels, *Workforce 2000*, prepared by the Hudson Institute, draws similar conclusions. It notes:

In 1986, minorities accounted for about 21 percent of the jobs in the American workforce of 115 million. Between 1986 and the year 2000, the number of jobs will increase by 21 million—and an astonishing 57 percent of those additional jobs will be filled by minorities. Yet if present trends continue, a dispro-

portionate number of those workers will lack the skills needed to do the job properly. Put another way, unskilled minorities are a growing fraction of the workforce and unless their abilities are upgraded, the nation's overall skill level will not be sufficient for tomorrow's economy.<sup>182</sup>

Businesses are also faced, at least in the short run, with a dearth of telecommunication talent.<sup>183</sup> Before divestiture, firms looked to AT&T to provide whatever limited telecommunication expertise they required. Today, however, their need for expertise is much greater, and the technologies they use are much more complex. Firms such as Westinghouse Electric, in Pittsburgh, PA, for example, have a real mix of facilities to manage, including T1 lines from four different carriers, a variety of multiplexer, channel banks, and AT&T 85 switches.<sup>184</sup> To meet their staffing needs, many companies have had to establish their own training programs. And the International Communications Association (ICA), which 5 years ago spent \$50,000 annually in support of telecommunication education, today spends \$305,000, which it distributes to telecommunication programs in 17 universities.<sup>185</sup>

<sup>179</sup>For one discussion, see "Human Capital: The Decline of America's Work Force," *Business Week*, Special Report, Sept. 19, 1988, pp. 100-141.

<sup>180</sup>NAEP defined literacy as: "Using printed and written information to function in society, to achieve one's goals, and to develop one's knowledge and potential." Irwin S. Kirsch and Ann Jungeblut, *Literacy: Profiles of Americans Young Adults*, Report No. 16-PL-02, p. 3, n.d.

<sup>181</sup>*Ibid.*, p. 6.

<sup>182</sup>*Workforce 2000*, Hudson Institute, 1988, as quoted in Arnold Packer, "Retooling the American Worker," *The Washington Post*, July 10, 1988, p. C3.

<sup>183</sup>David S. ...ps, "The Tough Search for Telecom Talent," *Datamation*, December 1987, pp. 65-72. See @1Glen Rifkin, "Facing Up to Hire Stakes," *Computerworld*, Feb. 13, 1989, p. 13.

<sup>184</sup>*Ibid.*, p. 66.

<sup>185</sup>*Ibid.*

## **Chapter 6**

# **Communication and the Democratic Process**

## CONTENTS

	<i>Page</i>
INTRODUCTION .....	145
THE POLITICAL REALM AND THE ROLE OF COMMUNICATION .....	145
NEW COMMUNICATION TECHNOLOGIES AND THE CHANGING ROLE OF GATEKEEPERS IN HISTORICAL PERSPECTIVE .....	147
KEY POLITICAL ACTIVITIES AND ACTORS .....	150
SOCIAL/POLITICAL CONTEXT IN WHICH NEW TECHNOLOGIES ARE EMERGING .....	151
Declining Political Participation .....	151
Blurring of the Boundaries Between Public Affairs and Entertainment .....	152
Increase in the Number and Complexity of the Demands Being Placed on Government .....	155
Erosion of National Sovereignty in the Context of an Increasingly Global Economy .	156
IMPACT OF NEW COMMUNICATION TECHNOLOGIES ON POLITICAL ACTIVITIES .....	158
Maintaining National Security and Sovereignty .....	158
Maintaining Internal Security and Social Welfare .....	163
Providing for Openness .....	166
Providing for Participation .....	170
Providing for Representation .....	175

### ***Box***

<i>Box</i>	<i>Page</i>
6-A. A Remote Sensing Satellite System .....	161

### ***Figures***

<i>Figure</i>	<i>Page</i>
6-1. Americans' Primary Media Sources of News .....	154
6-2. Which Media Report Is Most Credible? .....	154
6-3. Gallup Poll Results on Government Involvement .....	157
6-4. Development of Custom Targeting Database .....	168

### ***Tables***

<i>Table</i>	<i>Page</i>
6-1. Relationships Between Political Activities and Information Gatekeepers .....	151
6-2. Turnout of Registered Voters in 24 Countries .....	153
6-3. The Main Features of the "New" Political Economy in Post-Industrial Society . . .	156
6-4. Political Advertising on Television .....	171

# Communication and the Democratic Process

---

## INTRODUCTION

Political theory holds that political organization is limited by prevailing modes of transportation and communication and that it changes with improvements in these modes. Before the age of modern communication and transportation, political philosophers—ranging from Plato and Aristotle to Rousseau and Montesquieu—agreed that size and population served to limit democracy.<sup>1</sup> Based on the model of the Greek city-states, the ideal size for a democracy was a unit “so small that any citizen could travel on foot from the most remote point in a city-state to its political center and return in one day.”<sup>2</sup> Similarly, the population of a democracy had to be small and contained enough to allow interaction among its members. A polity so configured provided not only for popular representation, but also for effective government administration.

Given this relationship between the size and configuration of a community, its transportation and communication infrastructure, and its political organization, it is clear why the growth and expansion of the United States went hand in hand with the advancement and deployment of communication and information technologies. As James Beniger has pointed out, the advancement and application of these technologies were essential in providing the degree of control necessary for coping with the organizational complexity and scale of operation to which the industrial revolution gave rise.<sup>3</sup>

Today, the United States is taking its place in a global economy—one that is increasingly information-based. Just as the shift from an agricultural to an industrial society posed a number of challenges for the U.S. Government, so too will this most recent development. These major structural changes will give rise to problems of representation as well as problems of control.

Given the centrality of communication to all political activities, how the United States responds

to such problems of governance will depend, in part, on the evolution of the U.S. communication infrastructure, and on the rules that establish its development and use. This chapter will examine some of the political challenges that might arise and discuss how new communication technologies might be employed to address them. To this end, it will:

- characterize the political realm and describe the role of communication in it,
- discuss the past role of communication in the American political system,
- identify key political activities and actors,
- describe the political context in which the new technologies are emerging, and
- identify and analyze the opportunities afforded by new technologies and the major factors determining the political outcomes that these technologies might have.

## THE POLITICAL REALM AND THE ROLE OF COMMUNICATION

The polity is the realm of power. It is the area of social activity where disputes are resolved and social justice is defined, and where resources and values are allocated in accordance with the general idea of justice. The basic value that maintains the polity is “legitimacy”—the general adherence of the people to the conception of justice embodied in the society’s traditions or constitution, and acknowledgment of the authority that governs on its behalf.<sup>4</sup> In the political realm, change comes about somewhat haphazardly through the competition for power and influence. In a democratic polity, the means of bringing about change are participation and persuasion; individuals and groups seek to gain access to resources and values by shaping attitudes and beliefs about what constitutes justice. To be effective, they must have the right to obtain information as well as the right to distribute it.

---

<sup>1</sup>James W. Carey, *Communication as Culture: Essays on Media and Society* (Boston, MA: Unwin Hyman, 1989), p. 3.

<sup>2</sup>Ibid.

<sup>3</sup>James R. Beniger, *The Control Revolution: Technology and the Economic Origins of the Information Society* (Cambridge, MA: Harvard University Press, 1986).

<sup>4</sup>Daniel Bell, *The Cultural Contradictions of Capitalism* (New York, NY: Basic Books, 1976), p. 1.

Communication and information pervade political life. Without them there could be no Nation, for it is through the process of communication that people first develop a sense of community and a shared set of values that legitimize political authority.<sup>5</sup> By magnifying and amplifying some actions, the communication process distinguishes between what is a private act and what is a public affair. It organizes what appear to be random activities to show how individuals and groups are related to one another in the pursuit of power, providing a roadmap for individuals who want to influence the course of political events.<sup>6</sup> Citizens rely on the communication process to gather information, to identify like-minded people, to organize their forces, and to articulate their political preferences. Furthermore, because it generates a common fund of knowledge and information, the communication system facilitates productive and rational debate. Without some knowledge and understanding of how others are informed and what they believe, individuals could not make reasoned and sensible arguments and decisions.<sup>7</sup>

The communication process also provides guidance to political leaders. Because communication channels flow in two directions, communication serves not only to inform citizens about political events; it also provides feedback to political leaders about the values and attitudes of their constituents.

Political activities not only depend on communication; they also require constraints on the manner in which communication occurs. Thus, those in powerful positions have always attempted to control, or even restrict, access to communication paths.<sup>8</sup> As Donohue et al. have noted:

When man devised the first rudimentary form of mass communication centuries ago, he immediately developed ways of controlling it. Printer, king, teacher and merchant were almost equally inventive in contriving ways to bring information under control. Their diligence arose from man's historic recognition of a fundamental social principle: knowledge is basic to social power.<sup>9</sup>

While limitations on communication may not accord with some characterizations of democracy, many political theorists have argued, in fact, that some constraints on participation are necessary in order to preserve democracy. Aristotle, for example, favored "constitutional government" but was opposed to "direct democracy," which he called perverted because it failed to protect the rights and interests of the minority.<sup>10</sup> James Madison made much the same case in Federalist Paper 10, when he argued on behalf of "a government in which a scheme of representation takes place." Such concerns have also been echoed more recently by social scientists such as Joseph Schumpeter and B.R. Berelson. According to Schumpeter, for example: "The electoral mass is incapable of action other than a stampede."<sup>11</sup> Similarly, Berelson contends that, given the wide variety of citizens and their values, the range of issues on which public choice is allowed must be limited, if political democracy is to survive.<sup>12</sup>

Democracy depends, then, on the establishment of a delicate balance between "too little" and "too much" political communication. In negotiating this balance, "communication gatekeepers" play a criti-

<sup>5</sup>Karl Deutsch, *Nationalism and Social Communication* (New York, NY: Free Press, 1963).

<sup>6</sup>Lucian W. Pye (ed.), *Communications and Political Development*, Studies in Political Development (Princeton, NJ: Princeton University Press, 1965), p. 6.

<sup>7</sup>*Ibid.*

<sup>8</sup>Such control can be traced to the beginnings of recorded history. For example, in 213 B. C., the Chinese Emperor burned all the books in his kingdom and buried alive every scholar he suspected of having memorized them. John H. Gibbons, "Future Directions for Information Technology Policy," Leaders, February/March 1987, vol. 10, No. 1, p. 84. For more modern examples, see Ben H. Bagdikian, *The Information Machines: Their impact on Men and the Media* (New York, NY: Harper and Row Publishers, 1971); Ithiel de Sola Pool, *Technologies of Freedom* (Cambridge, MA: The Belknap Press of Harvard University Press, 1983); and Brian Winston, *Misunderstanding Media* (Cambridge, MA: Harvard University Press, 1986). For a theoretical discussion of why restricting access to communication paths is important, see Martha Feldman and James March, "Information in Organizations as Signal and Symbol," *Administrative Science Quarterly*, 1981, vol. 26, pp. 171-186.

<sup>9</sup>George A. Donohue, Phillip J. Tichenor, and Clarice N. Olien, "Gatekeeping: Mass Media Systems and Information Control," F. Gerald Kline and Phillip J. Tichenor (eds.), *Current Perspectives in Mass Communication Research* (Beverly Hills, CA: Sage Publications, 1972).

<sup>10</sup>Aristotle in *Twenty-Three Volumes, XXI Politics*, translated by H. Rackham (London: Heinemann, 1977), Book III, p. 207.

<sup>11</sup>Joseph A. Schumpeter, *Capitalism, Socialism and Democracy* (New York, NY: Harper Torchbooks, 1950), p. 283.

<sup>12</sup>B. R. Berelson, P. F. Lazarsfeld, and W. N. McPhee, "Democratic Theory and Democratic Practice," *Voting* (Chicago, IL: University of Chicago Press, 1954).



cal role.<sup>13</sup> Gatekeepers are the individuals or groups in a society who execute decisions about the formulation, exchange, and interpretation of information and knowledge. A gatekeeper might include, for example, a parliamentary representative, a government bureaucrat, or a member of the press. As Donohue et al. have noted, gatekeepers have an “immense potential for developing power over other human lives.”<sup>14</sup> The gatekeeper decides who has access to communication pathways, and thus who can actually play political roles and place issues on the political agenda.

How, and to whom, the role of communication gatekeeper is assigned varies across cultures, in different historical contexts, and in different organizational settings. Technological developments can also determine where and how gatekeeping takes place, and who will assume this role.

For example, in western societies, before the age of print, the church played a major role in controlling access to and the distribution of knowledge, as Umberto Eco’s novel, *The Name of the Rose*,<sup>15</sup> so intriguingly illustrates. With the development of print technology, a new system of information control was established, namely copyright, and new communication gatekeepers were required. Seeking to end the dissemination of heretical and seditious literature, while at the same time continuing to profit from the burgeoning printing trade, the British Government assigned publishers the role of gatekeeping. In exchange for the publishers’ agreement to enforce the censorship laws, the government granted the publishers’ guild, known as the Stationers, a monopoly right to print, publish, and sell their works.<sup>16</sup>

In the United States, the role of communication gatekeeping, and the rules governing the flow of information, were set early in American history in the first amendment to the Constitution, which

protects freedom of speech, the freedom of the press, and the right of people to peaceably assemble. \*7 Although these freedoms are not absolute and must be balanced against other political and social values, freedom of expression, especially for political purposes, has been recognized by the Supreme Court as being in a “preferred position.”<sup>18</sup>

## NEW COMMUNICATION TECHNOLOGIES AND THE CHANGING ROLE OF GATEKEEPERS IN HISTORICAL PERSPECTIVE

Given the importance of communication to political affairs, it is not surprising that as new technologies provided new communication pathways, policymakers had to reconsider the rules for access and gatekeeping. Before considering what policies might be appropriate for the new communication technologies, it is useful, therefore, to begin by examining how new technologies historically have affected access and gatekeeping.

The issue of control over access to communication pathways was already apparent during the colonial period, when, as in England, the British Government manned the gateways to communication paths. The working out of this issue during the course of early U.S. history illustrates a long, historical appreciation of the political relevance of communication policy.

Newspapers were plentiful and very important in the daily life of the colonies. Describing their central role, the Rev. Samuel Miller wrote in 1785:

A spectacle never before displayed among men, and even yet without a parallel on Earth. It is a spectacle, not of the learned and the wealthy only, but of the great body of the people; even a large portion of that class of the community which is

<sup>13</sup>The term “gatekeeper” is borrowed from the field of journalism. For a discussion, see D.M. White, “The Gatekeeper: A Case Study in the Selection of News,” *Journalism Quarterly*, vol. 27, Fall 1950, pp. 383-390.

<sup>14</sup>Donohue et al., op. cit., footnote 9.

<sup>15</sup>Umberto Eco, *The Name of the Rose*, translated by William Weaver (New York, NY: Harcourt Brace, 1983).

<sup>16</sup>Lyman Ray Patterson, *Copyright in Historical Perspective* (Nashville, TN: Vanderbilt University Press, 1968), ch. 4.

<sup>17</sup>These freedoms are at the core of what Thomas Emerson terms “the system of freedom of expression.” For a discussion, see Thomas I. Emerson, *The System of Freedom of Expression* (New York, NY: Vintage Books, 1970). For a good review of the rules and regulations that establish the rights and responsibilities of the press as gatekeeper, see Doris Graber, *Mass Media and American Politics* (Washington, DC: CQ Press, 1984), ch. 2.

<sup>18</sup>See Justice Stone’s footnote 4 i, *U.S. v. Caroline Products, Co.*, 304 U.S. 144 (1938). Some constitutional scholars, most prominently Alexander Meiklejohn, have argued that the first amendment is designed to give absolute protection to speech related to self-government. He argues that: “The primary purpose of the First Amendment is, then, that all the citizens shall, so far as possible, understand the issues which bear upon our common life.” See Alexander Meiklejohn, *Free Speech and Its Relation to Self-Government* (New York, NY: Harper & Bros., 1948), pp. 88-89.

destined to daily labor, having free and constant access to public prints, receiving regular information of every occurrence, attending to the course of political affairs, discussing public measures, and having thus presented to them constant excitements to the acquisition of knowledge, and continual means of obtaining it. Never, it may be safely asserted, was the number of political journals so great in proportion to the population of a country as at present in ours. Never were they, all things considered, so cheap, so universally diffused, and so easy of access.<sup>19</sup>

Although extremely popular and of high quality, colonial newspapers were decidedly conservative in their political outlook. This conservatism was due not only to the threats of censorship and libel action, but also to the fact that, as the printers' largest customers, the colonial governments basically subsidized the very first newspapers.<sup>20</sup>

British concerns about the distribution of seditious literature in the colonies were not unfounded, however. Newspapers and pamphlets served as the primary vehicles for public protest and revolt, providing a network of political communication that was crucial to revolutionary activities. And, with the onset of the revolution, printers, functioning as editors and publishers, took over the gatekeeping role.<sup>21</sup> In fact, it was in their shops that many a political story and idea were exchanged. It is interesting to note that, although much of the political opposition to British rule was directed at British restrictions on communication paths within the Colonies,\*\* these new gatekeepers were as adamant as their predecessors in suppressing dissident ideas.<sup>23</sup>

This appreciation of the power of the pen, together with their concerns about potential opposition, may account for the reluctance of the Constitution's authors to have journalists interpret the events of the Constitutional Convention for the public. For even

though they prohibited newspaper coverage of the proceedings, they made effective use of newspapers and other communication paths to build support for the ratification of the Constitution. Disguised as the columnist Publius, Alexander Hamilton, John Jay, and James Madison wrote a series of newspaper articles on behalf of the Constitution. These *Federalist Papers* proved critical in generating public understanding of, and support for, the new form of government.

A more permanent indication of the Founders' recognition of the political role of communication can be found, of course, in the Constitution's first-amendment provisions, protecting freedom of speech and press. Reflecting a distrust of government, and an appreciation for the importance of open communication to popular sovereignty and to maintaining a pluralistic society, James Madison, for example, wrote:

Popular government without popular information, or the means of acquiring it, is but a prologue to a farce or tragedy, or perhaps both. Knowledge will forever govern ignorance, and a people who mean to be their own governors must arm themselves with the power which knowledge gives.<sup>24</sup>

The Founders also fostered the development of the post system, recognizing its importance in developing the widespread public exchange of information necessary to create a sense of nationhood. Thus, as early as 1792, both political parties agreed that the government should subsidize newspapers. Also recognizing their own postal needs to communicate with constituents, the Members of the First Continental Congress granted themselves free postage. This franking privilege was continued after the Constitution was adopted.<sup>25</sup>

With the development of different political groups in the 19th century, political parties began to

<sup>19</sup>As quoted in Daniel J. Boorstin, *The Americans: The Colonial Experience* (New York, NY: Vintage Press, 1958), P. 327.

<sup>20</sup>*Ibid.*, pp. 233-234.

<sup>21</sup>See Richard Buel, Jr., "Freedom of the Press in Revolutionary America: The Evolution of Libertarianism, 1760-1820," Bernard Bailyn and John B. Hench (eds.), *The Press and the American Revolution* (Worcester, MA: American Antiquarian Society, 1980), pp. 59-97; and Frank Luther Mott, *American Journalism* (New York, NY: The Macmillan Co., 1941).

<sup>22</sup>Edwin Emery, *The Press and America* (Englewood Cliffs, NJ: Prentice-Hall Inc., 1962).

<sup>23</sup>Boorstin, op. cit., footnote 19.

<sup>24</sup>Saul K. Padover (ed.), *The Complete Madison: His Basic Writings* (Millwood, NY: Kraus Reprint, 1953), P. 337.

<sup>25</sup>*Inside Congress* (Washington, Dc: Congressional Quarterly, 1979), p. 127. Franking still provides an important means for Members of Congress to communicate with constituents, as reflected by the fact that on July 21, 1989, the House Appropriations Committee, Subcommittee on Legislative Appropriations, approved a record \$134 million for 1990 for mailings by Members of Congress. "Panel Votes Record \$134 Million for Growing House Mailings," *The Washington Post*, July 22, 1989, p. A2.

serve as gatekeepers, linking the public and the government. Party newspapers became a:

... major force for factional or party cohesion, communicating partisan information and views from the centers of power to the outlying communities.<sup>26</sup>

At the same time, through postage-free printers' exchanges, the party papers received political information from States and localities. Thus, their editors helped to synthesize a national political community that transcended local orientations.<sup>27</sup> Print communication remained relatively open throughout the 1800s, largely because of government efforts to ensure access. Subsidized postage rates allowed readers to subscribe to distant publications. Any town with a newspaper and post office could become a source of news for the rest of the Nation.

Although the telegraph dramatically increased people's ability to communicate quickly across the country, its high cost restricted access,<sup>28</sup> and thus its primary impact on the public was through the mediation of the press as gatekeepers.<sup>29</sup> Nevertheless, newspaper-owners feared that the telegraph companies themselves might enter the news business, thus usurping the owners' gatekeeping role. And, in fact, a new group-telegraph reporters--tried to establish itself as a gatekeeper, selling news to newspapers. However, within a short time these reporters joined the Associated Press (AP).<sup>30</sup> The telegraph did alter newsgathering and dissemination, however, and press associations such as AP were formed to share the costs of these activities.

By the late 1800s, some believed that AP and Western Union had become too powerful as gatekeepers, exploiting their monopolies to make it difficult for new papers and journals to get started. Congress considered over 70 bills for reforming the telegraph system. One would have given the govern-

ment ownership and control of the telegraph system, while another would have subsidized a competitor of AP and Western Union. With the decline of the Populist movement, however, calls for telegraph reform diminished in the face of strong lobbying from Western Union.<sup>31</sup>

Although telephones increased people's opportunities to communicate with one another in an informal and unmediated way, their expense limited widespread use for political purposes. At the turn of the century, telephones cost \$200 a year, a sum well beyond the means of most workers.<sup>32</sup>

Politicians gradually came to see telephones as being central to their activities. In 1878, Congress set up the first telephones in Washington to connect the Public Printer's Office with the Capitol so that members could order extra copies of their speeches. William McKinley was the first President who was comfortable with the telephone, using it in his 1896 campaign and later in the White House. With the deployment of telephones in more and more homes, they began to be used to canvass voters. By 1910, one commentator noted: "In apolitical campaign the telephone is indispensable."<sup>33</sup>

Radio initially provided a local or regional path of communication. However, it soon became more national through the use of telephone networks and commercial advertising. Throughout the 1930s and 1940s, commercial radio was the primary communication path by which politicians and national leaders could reach the Nation. President Roosevelt used his "fireside chats" to lift spirits during the depression and to rally Americans behind the war effort.

Early broadcasting law tried to ensure equal service and prevent a few urban centers from dominating radio. In an attempt to lessen the power of commercial radio as the gatekeeper for reaching

<sup>26</sup>William N. Chambers, *Political Parties in a New Nation* (New York, NY: Oxford University Press, 1963), p. 42. Chambers credits the press with forging national links among like-minded partisan factions.

<sup>27</sup>Richard B. Kielbowicz, "Newsgathering by Printers' Exchanges Before the Telegraph," *Journalism History*, vol. 9, Summer 1982, pp. 42-48; and Samuel Kernell, "The Early Nationalization of Political News in America," *Studies in American Political Development* (New Haven, CT: Yale University Press, 1986), pp. 255-278.

<sup>28</sup>In Europe, where the telegraph was a government monopoly supervised by the postal authorities, people made greater use of it. In the United States, if Samuel Morse had had his way, the telegraph would have become a government monopoly. Congress did subsidize the first experimental line, but decided not to buy the system, despite the recommendations of the House Ways and Means Committee (1845) and the postmaster general (1845, 1846). See Daniel J. Czitrom, *Media and the American Mind* (Chapel Hill, NC: University of North Carolina Press, 1982), p. 22.

<sup>29</sup>*Ibid.*, p. 14.

<sup>30</sup>*Ibid.*, pp. 16-17.

<sup>31</sup>*Ibid.*, pp. 28-29.

<sup>32</sup>Thiel de Sola Pool, *Forecasting the Telephone: A Retrospective Technology Assessment* (Norwood, NJ: Ablex Publishing Co., 1983), p. 82.

<sup>33</sup>AS quoted in *ibid.*, p. 79.

the Nation, the Wagner-Hatfield amendment, proposed in 1934, would have required the Federal Communications Commission (FCC) to broaden radio station ownership. The amendment called for the redistribution of all broadcasting channels and an allotment of one-fourth of all the radio broadcasting facilities to education, religious, labor, and other nonprofit associations. The amendment was defeated in the face of intense lobbying by commercial broadcasters.<sup>34</sup>

Television's critical role as a gatekeeper for communication in the political realm was recognized as early as 1948 when the Republican, Democratic, and Progressive parties all held their conventions in Philadelphia to take advantage of the coaxial cable, which allowed them to broadcast the proceedings over 4 networks to 18 stations in 9 cities.<sup>35</sup> The first daily network newscasts began later that year. Since that time, TV has become the most important path for national political communication. Network television coverage, as well as its production, of national political events has had a profound influence on the course of politics. As Christopher J. Matthews, the principal assistant to former House Speaker Thomas P. O'Neill, has described these changes:

At a dizzying pace, the TV news networks have absorbed many of the democratic functions traditionally held by political parties: the elevation of key public issues, the promotions of new leaders, the division of executive and legislative authority, and the constitution of political opposition.<sup>36</sup>

As the role of gatekeeper of political communication was shifted from the local newspaper proprietor, to the legislative representative, to the political party leader, to the television news analyst, politics in America was transformed in a number of significant ways. Local issues were superseded by national ones, while the production of political events began to take precedence over political debate. Changes on this order are also likely to occur in the future, given the widespread deployment of the new communica-

tion technologies. In fact, as described below, many such changes are already under way.

As new communication technologies come to play an enhanced role in the political realm, the key political questions that emerge are:

- . Who will assume the gatekeeping role with respect to new communication technologies?
- . What values and rules will govern the gatekeeper's behavior?
- . Where will the balance between "too little" and "too much" information be set? and
- . What will be the consequences for governance?

As Ithiel de Sola Pool has noted in this regard:

The important point about the way in which electronic and mass media operate is the fact that, as new sources of information or belief, they create counterweights to established authorities. Simultaneous radio coverage of war, a moon walk or whatever absorbs and fascinates the mass audience directly, cuts out traditional local purveyors of information and interpretation. It is not the imam or the chief of state who tells the people what happened and what it means. The people were there, along with the camera crew. The broadening of the arena of action transfers authority from the village bigwig returned from a visit to the district town, to nouveau powerful national leaders and eventually beyond them to world figures.<sup>37</sup>

## KEY POLITICAL ACTIVITIES AND ACTORS

Derived from the rich philosophical and cultural roots of the American past, political activities in the United States often call for different, and occasionally conflicting, values and role requirements. One philosophical tradition relates to the maintenance and operation of the minimal requirements of a government, and stresses the need for internal stability, integrity of the borders, and national sovereignty. A second fundamental American tradition is that of ensuring a democratic system—that is, providing for openness, participation, and represen-

<sup>34</sup>Daniel J. Czitrom, "Goals of the U.S. Communication System: An Historical Perspective," OTA contractor report, September 1987, p. 32.

<sup>35</sup>Reuven Frank, "1948: Live . . . From Philadelphia . . . It's the National Conventions," *The New York Times Magazine*, Apr. 17, 1988, pp. 37, 62-65. The networks' motivations were somewhat less than public-spirited, as gavel-to-gavel coverage was cheaper than carrying entertainment from studios, and TV-set manufacturers, who were also owners of two of the networks, saw this as a way of increasing sales. Sponsorship of the gavel-to-gavel coverage of three political conventions came to less than \$250,000. *Life Magazine* was the sole sponsor of NBC's coverage of all three conventions.

<sup>36</sup>As cited in Everett Carl Ladd, *The American Polity: The People and Their Government*, 3d ed. (New York, NY: W.W. Norton & Co., 1989), p. 17.

<sup>37</sup>Ithiel de Sola Pool, "Direct-Broadcast Satellites and Cultural Integrity," Arthur Asa Berger (ed.), *Television in Society* (New Brunswick, NJ: Transaction Books, 1987), p. 231.

**Table 6-1-Relationships Between Political Activities and Information Gatekeepers**

Political activity	Information gatekeepers
National security/ national sovereignty	President; Congress; State Department; foreign governments
internal security/ social welfare	Federal agencies, both law enforcement and public assistance; Congress; State & local governments
Providing for openness	Congress; news media; interest groups; Federal agencies
Providing for participation	Political parties; media; Congress; Interest groups; political consultants
Providing for representation	Political consultants; interest groups; electorate; parties

SOURCE: Office of Technology Assessment, 1989.

tation. A third philosophical tradition, which stems from the American liberal heritage, requires government to protect individual rights and to preserve a free-market system. And a fourth, and more recent, tradition commits the government to providing for the social welfare of the people, requiring government to devise and effectively administer or implement public programs.<sup>38</sup>

Drawing on these traditions, five basic political activities are identified for analysis in this chapter:

1. maintaining national sovereignty and national security,
2. maintaining internal security and social welfare,
3. providing for openness,
4. providing for participation, and
5. providing for representation.

Communication is essential to all five, although the gatekeepers of information and communication pathways may differ in each case. For example, the President and the Departments of State and Defense have long been the primary gatekeepers over the flow of messages between the United States and officials in other countries. But in providing for openness, the traditional press--daily newspapers, radio, TV, and national magazines--have played the primary role. In political campaigns, political parties

have been the most important gatekeepers for the flow of messages.

The relationships between political activities and information gatekeepers are laid out in table 6-1. Together, these activities and actors constitute much of the political realm. By examining how new communication and information technologies are affecting these relationships, it is possible to draw a rather comprehensive picture of what the future impact of these technologies on American politics might be.

## SOCIAL/POLITICAL CONTEXT IN WHICH NEW TECHNOLOGIES ARE EMERGING

The values and rules about access and gatekeeping change in response to the development of new communication technologies and changing communication pathways. They are also affected by the societal context in which political activities are carried out. Thus, to understand the impact of new communication technologies on the political realm, it is necessary to look first at the context in which these technologies are being developed and deployed.

### *Declining Political Participation*

One development that has colored the perceptions of, and expectations about, communication technologies in politics is the general decline of political participation in the United States over the past several years. Because technologies can offer new modes of participation, they have sometimes been viewed as a potential means of reengaging the public in political affairs.<sup>39</sup> On the other hand, some technologies, such as television, have been faulted for being the major contribute to the decline in public activism.<sup>40</sup>

Political participation can entail any number of activities ranging from keeping abreast of public affairs to running for public office. However, regardless of the activity involved, it is clear that political participation in the United States has been on the decline. Looking at the minimum level of

<sup>38</sup>For some discussions of American values, see Garry Willis, *Explaining America: The Federalist Papers* (Garden City, NY: Doubleday, 1981); Robert N. Bellah et al., *Habits of the Heart: Individualism and Commitment in American Life* (Berkeley, CA: University of California Press, 1985); and Louis Hartz, *The Liberal Tradition in America* (New York, NY: Harcourt, Brace and Co., 1955).

<sup>39</sup>See Richard Hollander, *Videodemocracy* (Mt. Airy, MD: Lomond Publications, Inc., 1985).

<sup>40</sup>See Austin Ranney, *Channels of Power: The Impact of Television on American Politics* (New York, NY: Basic Books, 1983).

participation--that of political awareness--we see, for example, **that** of the adults polled by the Roper Organization in 1982, only one-third had even a rough idea of the size of the current Federal deficit.<sup>41</sup>

The results are similar with respect to voting. Despite the fact that most of the institutional barriers to voting have been removed, the percentage of those voting in elections has actually been falling. For example, in the 1984 presidential election only 53 percent of those eligible voted; in 1988, the figure was only 51 percent. Voting for seats in the House of Representatives has been even lower, with only 38 percent of the voting-age public participating in 1986.<sup>42</sup> These low voting levels are even more striking when compared to voting levels in other advanced industrialized countries (see table 6-2).

Political analysts have offered a variety of explanations--some of them contradictory--for the low level of political participation in the United States. Some say that low participation reflects a general feeling that voting provides no real payoff. According to Ruy Teixeira, for example, "quite simply, for many Americans voting just doesn't seem worth the bother."<sup>43</sup> Similarly, but with a slightly different twist, Seymour Martin Lipset has attributed poor turnout to the stability of the system, and to the public's confidence that nothing too monumental, or extreme, will occur.<sup>44</sup> Others have explained the decline of public interest in terms of a loss of confidence in the system,<sup>45</sup> while still others believe that the need to actively register to vote has served to inhibit the uneducated and the poor.<sup>46</sup>

Although there are no single or definitive explanations of why many Americans do not vote or become active politically, there are some clues to suggest why people do. Correlations of socioeco-

omic factors with voting behavior show that education and affluence are the most important explanatory variables, with strong religious and moral beliefs also playing a role in encouraging participation.<sup>47</sup> Considered in light of the explanations cited above about nonvoting, these correlations are not surprising. The more educated and affluent people are, the more likely they are to feel they have something important at stake and can make a difference.

These observations suggest that the extent to which new communication technologies serve to foster or to discourage political participation will depend in large measure on whether or not they provide people with a greater sense of empowerment. If they are difficult to use or hard to come by, people will be discouraged and may be even less willing to take political initiative. On the other hand, if new technologies are employed to provide people with a greater sense of control over their lives, they could serve to generate an interest in politics.

### *Blurring of the Boundaries Between Public Affairs and Entertainment*

*News* has been treated as an economic commodity since the days of the telegraph.<sup>48</sup> However, the economic value of public affairs information was greatly enhanced by the development of more technically advanced ways to package and process it. This increase in economic value has been accompanied by a blurring of the boundaries between what constitutes entertainment and what constitutes public affairs.

Nowhere is this development more evident than in the televised, political, media event. With television, in fact, some would say that politics has become a

<sup>41</sup>As cited in Ladd, op. cit., footnote 36, p. 342. See also Norman Ornstein, Andrew Kohut, and Larry McCarthy, *The People, the Press, and Politics: The Times Mirror Study of the American Electorate* (New York, NY: Addison-Wesley Publishing Co. Inc., 1988), p. 54. In this survey, participants were asked: 1) whether they knew that the U.S. Government was in support of the opposition in Nicaragua; 2) whether there had been an increase in the Federal budget deficit over the last 5 years; and 3) whether the White House Chief of Staff was Howard Baker. Although 76 percent of those questioned said that they were aware of political issues, only 26 percent were able to correctly answer all three questions, while 32 percent were able to answer two out of three, and 42 percent could give only one or no correct answers.

<sup>42</sup>Ladd, op. cit., footnote 36, p. 417.

<sup>43</sup>Ruy A. Teixeira, "will & Real Nonvoter Please Stand Up?" *Public Opinion*, vol. 11, No. 2, July/August 1988, pp. 42, 44.

<sup>44</sup>Seymour Martin Lipset, *Political Man* (Garden City, NY: Doubleday, 1969), p. 181.

<sup>45</sup>See, for example, "The End of American Exceptionalism," *The Public Interest*, Fall 1975, pp. 197-198.

<sup>46</sup>See Frances Fox Piven, *Why Americans Don't Vote* (New York, NY: Pantheon, 1988).

<sup>47</sup>See Ornstein et al., op. cit., footnote 41, pp. 2-5.

<sup>48</sup>In the late 1870s, when the Associated Press was criticized for seeking control, it argued that collecting news was a business just like any other. As the AP general agent, James W. Simonton, said in 1879: "I claim that there is a property in news, and that property is created by the fact of our collecting it and concentrating it." As cited in Czitrom, op. cit., footnote 28, p. 27.

Table 6-2--Turnout of Registered Voters in 24 Countries

Country	Vote as a percentage of registered voters	Compulsion penalties <sup>a</sup>	Automatic registration
Belgium	94.6	Yes	Yes
Australia	94.5	Yes	No
Austria	91.6	No(some)	Yes
Sweden	90.7	No	Yes
Italy	90.4	Yes	Yes
Iceland	89.3	NA	NA
New Zealand	89.0	No(some)	No
Luxembourg	88.9	NA	NA
West Germany	88.6	No	Yes
Netherlands	87.0	No	Yes
United States	86.8	No	No
France	85.9	No(some)	No
Portugal	84.2	NA	NA
Denmark	83.2	No	Yes
Norway	82.0	No	Yes
Greece	78.6	Yes	Yes
Israel	78.5	No	Yes
United Kingdom	76.3	No	Yes
Japan	74.5	No	Yes
Canada	69.3	No	Yes
Spain	68.1	Yes	Yes
Finland	64.3	No	Yes
Ireland	62.2	No	Yes
Switzerland	48.3	No(some)	Yes

NA=notapplicable

a %compulsion penalties" refers to whether or not law in each country provides for penalties (fines, etc)forOtWing.

SOURCE: David Glass, **Peeverill** Squire, and Raymond **Wolfinger**, "Voter Turnout An international Comparison," *Public Opinion*, December/January 1984, p. 52. The authors based this table on the most recent election held in each country as of 1981. Reprinted with the permission of the American Enterprise institute forPublic Policy Research, Washington, DC.

spectator sport, with the public playing the role of passive audience. As one newspaper columnist has written:

Television has produced a couch-potato constituency... In some curious way, the most experienced political viewer becomes expert at one thing: television criticism. We become better equipped to criticize performance than policies. It is, after all, easier. . . I cannot prove that the rise of politics-as-television is responsible for the decrease of actual real, live voters. But how many viewer-voters have learned from television that they can reject politics because the program is boring? . . . In front of the television set, citizens are transformed into an audience.<sup>49</sup>

Given this development, some are concerned that television news now "sets the terms by which political judgments are rendered and 'political

choices made,"<sup>50</sup> a development that has negative implications for democratic government.<sup>51</sup>

How the media can serve to structure public affairs events can be seen by looking at recent political conventions. In the past, such events were designed primarily to provide a public forum for choosing a presidential candidate, and the party platform on which the candidate would run. Discussion and debate were essential to the process, and delegates were active participants, often stomping and whistling in accompaniment to long-winded speeches.<sup>52</sup> Today, in contrast, candidates are chosen prior to the convention and party discussions take place off-camera, allowing producers to create a more pleasing, unified picture for their viewing audiences.<sup>53</sup> While such programming may be more appealing from the perspective of entertainment, it

@Ellen Goodman, "Couch-Potato Campaigns," *The Washington Post*, Mar. 8, 1988, p. A19.

<sup>50</sup>Shanto Iyengar and Donald R. Kinder, *News That Matters: Television and American Opinion* (Chicago, IL: The University of Chicago Press, 1987), p. 4. For a discussion of how media can distort the news, see David L. Altheide, *Creating Reality: How TV News Distorts Events* (Beverly Hills, CA: Sage Publications, 1976).

<sup>51</sup>See David L. Altheide, *Media Power* (Beverly Hills, CA: Sage Publications, 1985).

<sup>52</sup>Nicholas von Hoffman, "Conventional History," *The New Republic*, Aug. 1, 1988, p. 27.

<sup>53</sup>Ibid.

**Figure 6-1—Americans' Primary Media Sources of News (multiple responses permitted)**

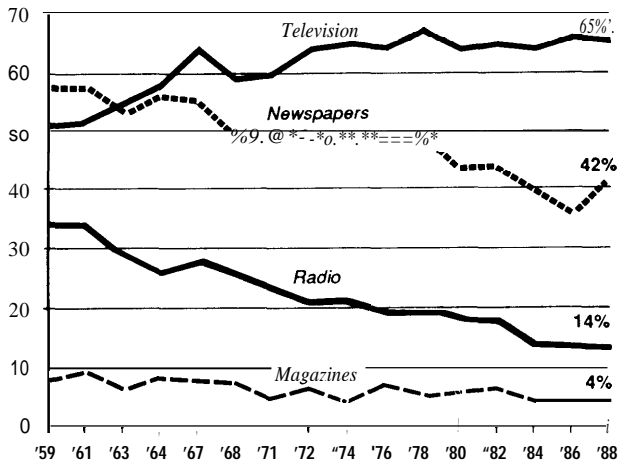

SOURCE: Reprinted with permission of the National Association of Broadcasters from "America's Watching, The 1989 TIO/Roper Report," p. 14.

can also distort the public's perception of politics and public affairs.

Whether or not such effects will be problematic for democracy will depend, in part, on the extent of the public's exposure to this kind of programming, the existence and availability of alternative media presentations, and the degree to which television substitutes for more active forms of political engagement. To date, most analyses suggest that television does have a significant political impact, although the relationship is much more complicated than was once believed.<sup>54</sup>

According to a recent survey by the Roper Organization, for example, television continues to serve as the "public's primary window on the world."<sup>55</sup> As can be seen in figure 6-1, about two-thirds of all adults generally get their news from television; 42 percent use newspapers as their major source of news; while 14 percent of the respondents rated radio tops and 4 percent named magazines. Moreover, as depicted in figure 6-2, almost one-half of the adult public view television as being the most credible media for news. In addition, more people cite television, as opposed to any other media, as

**Figure 6-2-Which Media Report Is Most Credible?**

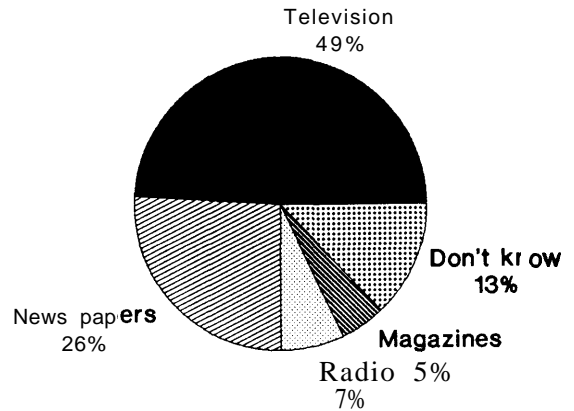

SOURCE: Reprinted with permission of the National Association of Broadcasters from "America's Watching, The 1989 TIO/Roper Report," p. 15.

their primary source of information about political candidates.<sup>56</sup>

Comparing media choices in terms of socioeconomic and demographic data, a recent Gallup Poll finds that different kinds of voters rely on different kinds of media. According to this poll, those who turn to newspapers rather than to television for information on national affairs are:

... more sophisticated and, on balance, more Republican than the nation as a whole. Newspaper readers are more tolerant, less alienated, yet less religious and less in favor of social welfareism.<sup>57</sup> . . . [T]hose who rely on newspapers, in contrast to those who rely on television for providing information on national affairs, are better educated, possess a higher level of interest and involvement in politics and are more likely to vote.<sup>58</sup>

Data such as these raise the possibility that, instead of serving to provide a common, national political perspective, the role of broadcast media in politics may actually be to reinforce socioeconomic differences.

Despite concerns about the negative impact of television in politics, some people believe that new

<sup>54</sup>The relationship between media and the audience is discussed in more detail in ch 7.

<sup>55</sup>*America's Watching*, the 1989 Television Information Office Report, p.14.

<sup>56</sup>*Ibid.*, p. 18.

<sup>57</sup>Ornstein et al., op. cit., footnote 41, P. 5.

<sup>58</sup>*Ibid.*, p. 61.



communication technologies could actually serve to reawaken the public interest. They emphasize, however, that if technologies are to play such a role, they will need to be much more engaging than they have been in the past. As one communication scholar points out:

The public will begin to reawaken when they are addressed as a conversational partner and are encouraged to join the talk rather than sit passively as spectators before a discussion conducted by journalists and experts.<sup>59</sup>

### ***Increase in the Number and Complexity of the Demands Being Placed on Government***

Although the government has always played some role in sustaining the Nation's economy,<sup>60</sup> it is only in the wake of the Depression and World War II that government began to intervene on a large scale, not only in economic affairs but in all phases of social life. This shift in the Federal Government's role is depicted in table 6-3,

Given the growing responsibility of government, some social scientists fear that the government may become overloaded. Problems of overload could take a number of forms. Anthony King predicts, for example, that in the future:

- government policies will fail more often,
- political arrangements will be called into question,
- there will be problems of complexity in addition to those of scale, and
- the state will have to compete with other groups and institutions for power.<sup>61</sup>

Similarly, Richard Rose postulates that big government is likely to lead to:

- . a loss of effectiveness due to the lack of explicit and tested techniques for realizing social goals;
- more conflicts among policy programs, given the interdependencies among problems; and

- . less consent for government to act beyond its traditional responsibilities.<sup>62</sup>

And, according to Claus Offe, with the emergence of such problems, citizens will withdraw from official channels for resolving conflicts and articulating their preferences. As he predicts:

Politics as the struggle over substantive issues and politics as the institutional form of conflict resolution degenerates into informal and mutually disconnected modes of struggle and decision. The constitutional bridge that democratic theory takes for granted is in the process of breaking down.<sup>63</sup>

A significant sector of the public also registered concern about the growth in size and poor performance of government, as illustrated by opinion polls conducted over the past two decades.<sup>64</sup> The number of those rating the government's performance favorably has increased considerably since hitting a low point of 21 percent in 1980. However, after the stock market crash in October 1987, this number fell 11 points to 58 percent from a high of 69 percent in July 1986.<sup>65</sup> One paradoxical feature revealed in these surveys is that, while the public is often critical of the government's size and performance, a great many people continue to view the government's role as one of providing public support, as can be seen in figure 6-3. Thus it would appear that, even in the face of continued protests, the trend toward greater demands on government is unlikely to disappear.

Communication and information technologies contributed solutions to problems of control generated during the course of industrialization. Similarly, new communication technologies offer potential solutions to the problems of governing a post-industrial society. However, to the extent that the demand for technological solutions increases in the face of greater demands on government, extra attention will need to be paid to maintaining the appropriate balance between communication access and control.

<sup>59</sup>James W. Carey, "The Press and the Public Discourse," *The Center Magazine*, March/April 1987, p. 14.

<sup>60</sup>While in theory the government's role under a laissez-faire arrangement is merely to provide a stable legal framework in which business relationships can take place, in practice, the government has played a much more substantial role, providing the social overhead capital—canals, roads, railroads, communications, education, and training—that allowed businesses to flourish. See Bruce L. I. Smith (ed.), "The Public Use of the Private Sector," *The New Political Economy: The Public Use of the Private Sector* (London: Macmillan Press Ltd., 1976), p. 4.

<sup>61</sup>Anthony King, "Overload: Problems of Governing in the 1970s," *Political Studies*, vol. 23, Nos. 2-3, June-September 1975, pp. 162-174.

<sup>62</sup>Richard Rose, "What If Anything Is Wrong With Big Government," *Journal of Public Policy*, vol. 1, No. 1, pp. 5-36.

<sup>63</sup>Claus Offe, "The Separation of Form and Content in Liberal Democratic politics," *Studies in Political Economy*, Spring 1980, p. 11.

<sup>64</sup>Ladd, op. cit., footnote 36, p. 366.

<sup>65</sup>Ibid., p. 368.

**Table W-The Main Features of the “New” Political Economy in Post-Industrial Society**

Early industrialization	Managed economy	“New” political economy
Early and Middle 19th century in U.S. and U.K.	Late 19th and early 20th centuries	Post-World War II
Government intervention in the provision of social overhead capital	Laissez-faire gradually replaced by regulation	Massive governmental intervention in all phases of social and economic life; public-private lines blurred
Episodic ad hoc interest groups, beginning of mass-based political parties	National trade unions and manufacturing associations, strong parties	Looser interest groups; “military-industrial complex,” environmental lobby; weakening of parties
Gentlemen amateur and/or “common man” tradition in civil service	Emergence of highly disciplined, hierarchical, and professionalized civil service	Permeable civil service drawing its professional energies outside of government
Stakes of government law and order, land grants, special charters, and other favors (distributive politics)	Conditions of labor, curbing of industrial abuses, promotion of economic growth and employment, preoccupation with standard of living (regulatory politics)	Preoccupation with quality of life, “universal entitlement,” Spaceship Earth, price stability and “delicate tinkering” with economy (consumer politics)

SOURCE: Bruce L.R. Smith, *The New Political Economy: The Public Use of the Private Sector* (New York, NY: The Macmillan Press, 1975), p. 4. Reprinted with permission.

### *Erosion of National Sovereignty in the Context of an Increasingly Global Economy*

The notion of national sovereignty began to take form in the 16th century, in conjunction with the rise of the nation-state system.<sup>66</sup> It implied that, within a given territory, a sovereign power was self-contained and autonomous, and enjoyed mutually exclusive jurisdiction over all activities.

In the United States, the idea of national sovereignty found support among the Founding Fathers who, in writing the Constitution, sought to improve on the failings of the Articles of Confederation. In Federalist Paper Number 23, Alexander Hamilton described national sovereignty as being necessary to provide for:

... the common defense of the members; the preservation of the public peace, as well against internal convulsions as external attacks; the regulation of commerce with other nations and between the states; [and] the superintendence of our intercourse,<sup>67</sup> political and commercial, with foreign countries.

Many shared Hamilton’s view that the United States needed a strong national government capable of

taking direct action to protect and develop U.S. interests.<sup>68</sup>

Today, many of these traditional assumptions about national sovereignty are unraveling. In a global community and global economy, nation-states are more interdependent in terms of the kinds of problems they face. In addition, new forms of business enterprise have altered the nature of private power and its relationship to public sovereignty. Together, these developments weaken national authority, both domestically and abroad, exacerbating government problems of control.

Just how interdependent nation-states have become was first made clear with the development of nuclear weapons and their potential for mutual destruction.<sup>69</sup> More recently, governments have had to join together to address a broad range of issues, including those having to do with the environment, international trade and finance, health, and communication. In some cases, such as that of the European Community, nations have had to formally renounce aspects of their sovereignty in order to cooperate effectively.

<sup>66</sup>For an account of the rise of the nation-state system, see John H. Herz, *The Nation-State and the Crisis of World Politics* (New York, NY: D. McKay, 1976).

<sup>67</sup>Federalist Paper, #23.

<sup>68</sup>William N. Eskridge, Jr., “Sovereignty and the Constitution in the Era of Multinational and Transnational Business Enterprises,” OTA contractor report, April 1987.

<sup>69</sup>For a discussion of the impact of nuclear weapons on the nation-state system, see Herz, op. cit., footnote 66.

Figure 6-3-Gallup Poll Results on Government Involvement

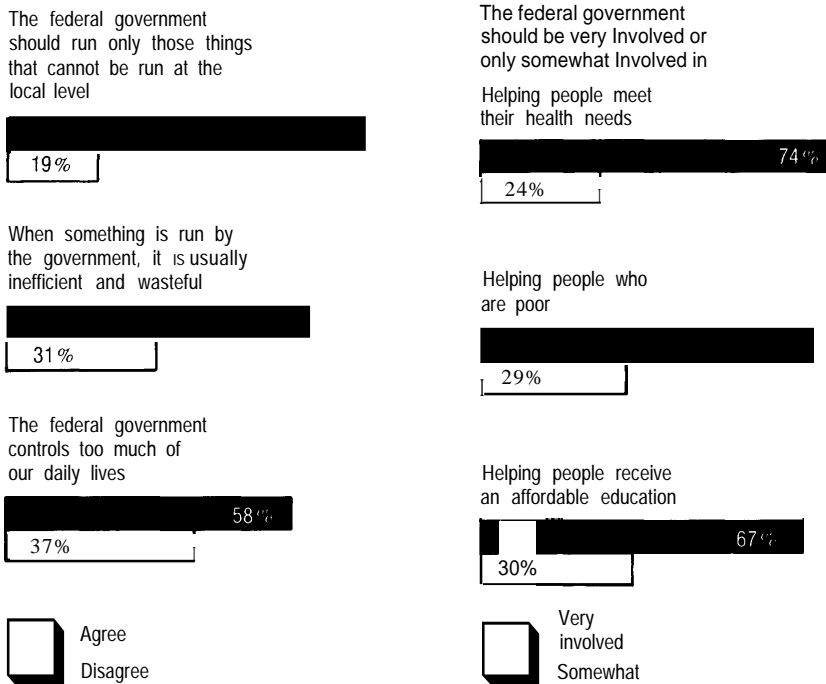

SOURCE: Survey by the Gallup Organization for Times-Mirror Co., Apr. 25-May 10, 1987; and survey by *Time/Yankelovich Clancey Shuyman*, Feb. 17-18, 1987. Reproduced from *The American Polity*, 23rd ed., by Everett Carl Ladd, by permission of W.W. Norton & Co., Inc. Copyright (c) 1989, 1985 by W.W. Norton & Co., Inc.

National sovereignty has also been weakened by the rise of the translational corporation.<sup>70</sup> Given their size and resources, translational corporations have their own bases of power. Such corporations are now big enough to compete with government as buyers, and they are dispersed enough to play nation-states off against one another. Moreover, corporate actions can constrain the ability of the state to act, especially in such areas as the balance of payments, income distribution, and regional development.<sup>71</sup> Characterizing this situation, Barnet and Muller point out:

When we say that the new international economy now being built by global corporations threatens the sovereignty of the nation-state, we mean that its principal domestic powers and functions—the power to raise revenue, maintain employment

provide adequate social services, encourage the equitable allocation of income and wealth, maintain sound currency, keep prices and wages in line; in short the power to maintain a stable social equilibrium for the greater majority of its population—is being seriously undercut.<sup>72</sup>

Serving as the means for organizing and interconnecting business operations, communication technologies continue to play a key role in facilitating the development of a global economy. Recognizing this fact, businessmen are now seeking to become more active in the design and development of the international communication infrastructure. The Society for Worldwide Interbank Financial Telecommunications (SWIFT), for example, was set up by the banking community to simplify international electronic funds transfers. And private companies are

<sup>70</sup>To some extent, the modern corporation has always been problematic with respect to the question of national sovereignty, given its size and the range of its activities. As one observer has described: “Those who own economic goods exercise a kind of governmental power. Being entitled to their property or part with it as they choose, the owners like petty sovereigns can dictate the terms and conditions their neighbors must perform to access to the property. In this sense every lawful economic power becomes a type of political power.” Edmond Cahn, as cited in Arthur S. Miller, *Modern Corporate State: Private Governments arise the American Constitution* (Westport, CT: Greenwood Press, 1976), p. 41.

<sup>71</sup>Raymond Vernon, “Sovereignty at Bay Ten Years After,” *International Organization*, No. 3, Summer 1981, pp. 517-529.

<sup>72</sup>Richard J. Barnet and Ronald E. Muller, *Global Reach: The Power of the Multinational Corporations* (New York, NY: Simon & Schuster, 1974), p. 373.

increasingly viewing international standards-setting problems from the perspective of the translational corporation rather than from the perspective of the nation-state.

Taken together, these four political trends set the context in which new communication technologies are emerging. The first two trends highlight the need for government to keep in mind, when considering policy relating to new technologies, the problem of political access. The latter two focus on problems of effective governance and control.

## IMPACT OF NEW COMMUNICATION TECHNOLOGIES ON POLITICAL ACTIVITIES

### *Maintaining National Security and Sovereignty*

To maintain its sovereignty and security, a nation-state needs to:

- communicate with the heads of other countries (diplomacy),
- influence public opinion in other countries (propaganda),
- gather information on what is occurring in other countries (intelligence), and
- be able to assume control of national communication in a national emergency (emergency preparedness).

Central to the performance of these activities is a global communication system that provides for secure and reliable communication and is invulnerable to outside interference or jamming.

Before rapid global communication, communication for state purposes, such as diplomatic functions, took place through ordered channels, usually at the highest levels of governments. Communication was generally rather slow, with time for deliberation on

both sides. It was, moreover, somewhat hidden from the view of those without a “need to know.” The traditional gatekeepers in the area of national sovereignty--exercising control over access to state-related information, the means of communication, and the audience or receiver of the message—have been the President, the Department of State, and the Department of Defense. AT&T, as the dominant domestic and international telecommunication service provider, has operated in concert with the Federal Government as the gatekeeper for the flow of communication between countries and within the United States defense community. The national and international press, as reporters and interpreters of national and international events, have also played important gatekeeping roles.

Today, these gatekeepers are changing in response to two major communication-related developments—the proliferation of telecommunication networks and the use of remote-sensing satellites. Altering communication pathways on a global scale, these developments will have a significant impact on the Nation’s sovereignty and security.

### **Proliferation of Telecommunication Networks in a Competitive Environment**

Because the government is a major user of telecommunication services, and because it must be able to “take over” telecommunication in case of a national emergency or war,<sup>73</sup> any changes in the ownership and management of the network will affect the government and its ability to maintain security. Two recent developments raise concerns in this regard—the growth in competition with the divestiture of the Bell telephone system,<sup>74</sup> and the proliferation of private telecommunication networks, many of which now operate on a global scale.

One of the largest government users of the commercial telecommunication system is the Department of Defense (DoD), which uses nongovernment lines for about 95 percent of its data and voice

<sup>73</sup>Section 706 of the Communications Act of 1934 allows the President to commandeer the communication industry during a crisis that he believes threatens the sovereignty of the Nation. See Harold Relyea, “Stretch Points of the Constitution: National Emergency Powers,” Ralph S. Pollack (ed.), *Renewing the Dream* (Lanham, MD: University Press of America, 1987), pp. 75-91; and Robert L. Chartrand and Trudie A. Punaro, “Information Technology Utilization in Emergency Management,” Library of Congress, Congressional Research Service, Report No. 85-74S, Apr. 9, 1985.

<sup>74</sup>Surprisingly, little attention was given to the national security implications of the AT&T divestiture during the AT&T antitrust suit. The Department of Justice case was focused almost exclusively on AT&T’s past anticompetitive behavior, although DoD testified on AT&T’s behalf. See Martin Edmonds, “Defense Interests and United States Policy for Telecommunications,” OTA contractor report, June 1988, pp. 22-26, for the role of DoD during the antitrust settlement.

communication at a cost of over \$1 billion annually.<sup>75</sup> DoD, moreover, is not an ordinary customer; it has special needs. To fulfill its mission, DoD must have access to a communication system that, among other things, provides:

- the connectivity required to join the National Command Authority with the U.S. Armed Forces before, during, and after an attack;
- support for mobilization;
- operational control during conflict;
- support for the continuity of the government after attack or a natural disaster;
- the capability to be reconstituted after such events; and
- the ability to protect sensitive and secret information at all times.

In the past, AT&T, as the only company effectively supplying end-to-end telecommunication services to the Defense Communications Agency (DCA), was able to meet these needs. To do so, however, it played a major role in designing and managing the system. For example, AT&T was directly involved in the formulation of national security telecommunication specifications and requirements; in telecommunication research and development; in the planning, routing, and installation of networks; and in making provisions to govern system robustness, ubiquity, and restorability. Given AT&T's monopoly, end-to-end connectivity was assured. Not infrequently, AT&T would install a telecommunication line or circuit for DCA, reroute or harden a cable to enhance survivability, or retain redundant lines without making a direct charge to the defense budget; the cost would be absorbed in the overall rate base to AT&T subscribers.<sup>76</sup> Finally, the sheer size of AT&T and the extent of its network meant that it was able, as a company, to meet the more demanding requirements of the U.S. Armed Services. For example, because of the spare capacity that AT&T had, and the "last-mile" provision that

linked out-of-the-way military units and command posts, it was possible to have a fast emergency response.<sup>77</sup>

Breaking up this highly integrated telephone system, the Modified Final Judgment (MFJ) completely restructured the communication environment for defense. However, some provisions for national security coordination were made. The MFJ, for example, required the regional Bell operating companies to establish a single point of contact through Bell Communications Research Inc. Moreover, with Executive Order 12382, President Reagan formally established the National Security Telecommunications Advisory Committee (NSTAC). Comprising the chief executive officers of the major telecommunication companies—27 in all—NSTAC was charged with the task of advising the President on national security emergency preparedness (NSEP) telecommunication matters. Moreover, in 1984, responding to one of NSTAC's first recommendations, the government also set up the National Coordinating Committee, comprised of industry and government representatives, to coordinate their respective companies' efforts in conjunction with government agencies such as DCA and the Federal Emergency Management Administration in the event of an emergency.<sup>78</sup>

Now that the telephone system is no longer one "network," managed by one company and supplied from a limited number of equipment providers, the government must provide for its own communication needs, dealing with a variety of new telecommunication service and equipment providers.<sup>79</sup> This management problem can be quite complex, as the National Research Council (NRC) has described with respect to the case of customer premises equipment (CPE). As NRC notes:

The bewildering diversity of available CPE can seriously complicate NSEP management. When Western Electric was the sole CPE manufacturer for

<sup>75</sup>It is a matter of national policy that Federal Government requirements for telecommunication services, including those of defense, should be procured from the commercial sector, unless special circumstances dictate otherwise. In 1981, it was estimated that 85 percent of the Federal Government and 94 percent of critical U.S. national security communication needs within the continental United States were leased from the commercial telecommunication carriers. *Ibid.*, p. 18.

<sup>76</sup>U.S. Senate, Committee on the Judiciary, Hearings on Department of Justice Oversight, *U.S. v. AT&T, 97th Cong., Aug. 6, 1981, p. 42.*

<sup>77</sup>G. Boiling, "AT&T: Aftermath of Anti-Trust," National Defense University, Washington, DC, 1984, pp. 27-28.

<sup>78</sup>*Ibid.*

<sup>79</sup>In most cases, Computer II prevents an user, including DoD, from acquiring a complete system of equipment and manumission from AT&T. although for reasons of national security/emergency preparedness, AT&T is permitted to manage end-to-end control for 21 communication systems. For discussion of the changing communication environment, see John Horgan, "Safeguarding the National Security," *IEEE Spectrum*, November 1985, pp. 84-89; and Wey R. Irwin, "National Security and Information Technology: The New Regulatory Option?" *Government Information Quarterly*, vol. 4, No. 4, pp. 359-369.

the **integrated** Bell System, Bell System managers were fully acquainted with the characteristics of the CPE connected by wire to the network. By contrast, today, and even more so tomorrow, no network-based company is likely to have knowledge of more than a few major CPE systems. Customers are free to interconnect the equipment of their choice to the network, without even notifying the telephone companies. Further, the proliferation of interfaces between the customer's premises and the public and private networks will complicate loop testing and billing verification. Other future uncertainties would include CPE configured to be voice activated by specific users only.<sup>80</sup>

Competition in the telecommunication sector can also give rise to new problems for defense. In a highly competitive environment, there is less incentive for providers to build redundancy into their networks, and users, facing their own competitors, are more inclined to choose efficiency over robustness. Thus we see, for example, that a number of new technologies are being deployed—such as fiber optics, digital switching, and software control—that, while making a communication system much more efficient, also make it much more vulnerable.<sup>81</sup>

Deregulation and competition also facilitate the proliferation of private networks, a trend that, as discussed in chapter 5, is being reinforced by the enhanced role of information in the business realm. Although private networks could conceivably provide greater redundancy in the national communication network, they are not being set up to play this role. In fact, as NRC has pointed out:

Many private data networks, both circuit and packet switched, are not fully interoperable with the public switched networks. Thus, as a source of potential network redundancy they are extremely limited, unless linked to the public networks by gateway architectures.<sup>82</sup>

To the extent that there is a wide variety of network providers as well as some very large private users, the government, in the future, may no longer be able to set its own priorities for the network. Private users may have their own set of communication needs

apart from national security, and they may be unwilling to subsidize the government's requirements for network security and reliability.

Problems of security may be exacerbated, moreover, if government regulatory policies that foster competition provide widespread access to the internal workings of the public switched network. One area where this might happen, for example, is in open network architecture (ONA). As NRC cautions:

ONA can increase network vulnerability to such disruptions in two ways. First, ONA increases greatly the number of users who have access to network software. . . . Second, as more levels of network software are made visible to users for purposes of affording parity of network access, users will learn more about the inner workings of the network software, and those with hostile intent will learn more about how to misuse the network.<sup>83</sup>

### Remote Sensing Satellite Systems

Remote sensing refers to photographing Earth from space. First carried out in the 1960s with the launch of the TIROS weather satellite, the process entails a number of steps:

- taking a picture from space,
- transmitting it in the form of raw data to a relay satellite,
- communicating the information to a receiver on the Earth,
- converting the raw data into photographic images or computer tapes,
- processing and removing geometric and other distortions, and
- interpreting and analyzing the images.

The components of a remote sensing system are described in box 6-A. At present there are two operational remote sensing systems: Earth Observation Satellite Co. (EOSAT)—formerly the U.S. Government's Landsat system—and SPOT, a French system that is responsible for marketing data from the satellite owned by the French Government.<sup>84</sup>

<sup>80</sup>National Research Council, *Growing Vulnerability of the Public Switched Networks Implications for National Security Emergency preparedness* (Washington, DC: National Academy Press, 1989), pp. 70-71.

<sup>81</sup>*Ibid.*, pp. 46-47.

<sup>82</sup>*Ibid.*, p. 29.

<sup>83</sup>*Ibid.*, p. 36.

<sup>84</sup>EOSAT (Earth Observation Satellite CO.) is a private company that now handles the operation and marketing of data for Landsat, formerly owned by NASA. For a history of the transfer of the Landsat system to the private sector, see U.S. Congress, Office of Technology Assessment, *Remote Sensing and the Private Sector: Issues for Discussion*, OTA-TM-ISC-20 (Springfield, VA: National Technical Information Service, March 1984).

### Box 6-A—A Remote Sensing Satellite System

A remote sensing satellite system consists of four major components, each of which is critical to producing useful data:

1. *The Spacecraft, Sensors, and Transmitters:* The spacecraft provides a stabilized platform and power for the sensors and their optics, the receiving and transmitting antennas, and the associated electronics necessary to control the spacecraft and to deliver data to Earth. Some remote sensing spacecraft may also carry tape recorders to store data until the spacecraft is within sight of a receiving station.
2. *The Receiving Station and Other Communications Components:* A ground station may receive data in digital form directly from the satellite as it passes overhead, or, if the satellite is not in a position to communicate with the ground station, through a system equivalent to NASA's 3-satellite Tracking and Data Relay Satellite System (TDRSS).<sup>\*</sup> In the latter case, data are passed from the remote sensing satellite to a communication satellite in geosynchronous orbit and then retransmitted to a ground facility. From the ground facility, the data are then passed directly to a processing laboratory.
3. *The Data Processing Facilities:* Before the raw data can be converted into photographic images or computer tapes capable of being analyzed by the end user, they must be processed to remove geometric and other distortions inevitably introduced by the sensors. For the purposes of newsgathering, high-speed mainframe computers may be required to process the data from current spacecraft.
4. *Interpretation of the Data:* After the raw data are processed and converted to computer tapes or photographs, they must be interpreted. Part of the interpretation process may involve merging or integrating other data either directly on the computer tape, or comparing such data with photographs. At this stage, computer analysis could be performed by micro- or mini-computer. A variety of advanced techniques are available to turn remotely sensed data into new products for different users.

<sup>\*</sup>Only one TDRSS satellite is currently in orbit.

SOURCE: U.S. Congress, Office of Technology Assessment, *Commercial Newsgathering From Space—A Technical Memorandum, OTA-TM-ISC-40* (Springfield, VA: National Technical Information Service, May 1987), p. 8.

As the cost of such systems declines and the resolution of satellite data improves, the value of remote sensing for intelligence, environmental, and commercial purposes will increase, raising the question of who should have access to remote sensing data and on what basis. While greatly enhancing access to information, an increase in the use of remote sensing systems could also impair national security and constrain the government's ability to exercise national sovereignty. One instance in which such a conflict might arise, for example, is in the case of the use of remote sensing by the press.

With declining costs and increased quality, remote sensing could prove to be an especially useful means of newsgathering. For example, it would allow the media to gain access to remote places or sites to which access has been denied; to perform real-time data recovery; and to provide the kind of repeated coverage of an area that is necessary to monitor changes.

Were the media to make use of remote sensing satellites for newsgathering, there might also be a

number of benefits for the public-at-large. Circumventing geographic and political barriers to the free flow of information, for example, remote sensing might encourage the development of a global village. Using such systems would, moreover, increase public information on world affairs, as happened in the case of the Chernoble nuclear accident. In addition, to the extent that nations temper their behavior in the face of world opinion, such transparency might have a stabilizing influence on world affairs. Used by the U.S. Government to gather intelligence, remote sensing satellites could also serve to enhance national security and national sovereignty.<sup>85</sup>

Such transparency, however, could also be destabilizing. Nation-states have traditionally served as the gatekeepers of international information, and they would certainly be reluctant to renounce such control. At the very least, they would not want to risk increased visibility of their military operations. Moreover, media coverage on such a scale might reveal sensitive information; complicate foreign relations and reduce diplomatic channels; lessen the

<sup>85</sup>For a discussion, see Daniel Charles, "Spy Satellites: Entering a New Era," *Science*, Mar. 24, 1989, pp. 1541-1543.

government's control during a crisis; and erode citizens' expectations of privacy.<sup>86</sup>

Recent events in China demonstrate some of the benefits and problems that might result from this kind of enhanced international news coverage. The international media coverage of the Chinese student protesters generated international support for their cause. However, by rallying such support, the media coverage may have actually provoked the Chinese Government to take more extreme retaliatory measures.

A number of factors will determine how the balance between access and national security will be struck in the case of remote sensing. Two important factors are the further development of the technology and a reduction in its costs. With respect to the media's use of remote sensing, the OTA technical memorandum, *Commercial Newsgathering From Space*, points out:

To be financially viable, a mediasat would have to generate revenue sufficient to offset the costs of the system. Experts have estimated that a complete one or two satellite mediasat system capable of 5 meters resolution, designed to operate about 5 years, could cost between \$215 million and \$470 million to establish, and \$10 million to \$15 million a year to operate. Even if each network used satellite images every day, only a few thousand images would be used per year; hence the system's development and operating costs could only be paid back if networks were willing to pay \$35,000 to \$73,000 per "story," an order of magnitude more than existing expenditures for daily news coverage.<sup>87</sup>

Technological factors will also determine the vulnerability of a system to manipulation or interfer-

ence from other countries or hostile forces, or the possibility that it might be targeted and destroyed in space.

The impact of remote sensing on national security will also be determined by the rules governing its use. One important set of rules will be those that govern commercial ownership. Until 1984, U.S. satellite remote sensing services were government-run, first by the National Aeronautical and Space Administration (NASA) and then by the National Oceanic and Atmospheric Administration (NOAA). However, in 1984, Congress privatized remote sensing, and EOSAT won the contract for offering these services within standards determined by national security.<sup>88</sup>

Other rules that will affect the use of remote sensing technology are those pertaining to the first amendment. However, these rules are unclear at present. One source of confusion is that the Supreme Court has not determined whether newsgathering is itself a protected first-amendment activity, separate from speaking and publishing.<sup>89</sup> Nor has the Court decided whether the government has a positive duty to allow journalists special access to information.<sup>90</sup> As the OTA report, *Science, Technology, and the First Amendment*, points out, technology is likely to blur distinctions between gathering information and publishing it, and hence the Court will eventually have to confront the question of whether the press interest in gathering news merits constitutional protection under the first amendment, and whether remote sensing constitutes a tool that should be made available to the press for such purposes.<sup>91</sup>

<sup>86</sup>For a discussion, see U.S. Congress, Office of Technology Assessment, *Commercial Newsgathering From Space*, OTA-TM-ISC-40 (Springfield, VA: National Technical Information Service, May 1987), p. 4.

<sup>87</sup>Ibid.

<sup>88</sup>Irwin, op. cit., footnote 79, p. 363.

<sup>89</sup>The Supreme Court said in *Branzburg v. Hayes* that "it is not suggested that news gathering does not qualify for First Amendment Protection: without some protection for seeking out the news, freedom of the press could be eviscerated." *Branzburg v. Hayes*, 408 U.S. 665 (1972).

<sup>90</sup>The press has access to government proceedings, records, or other information that is available to members of the public generally. And presumably the converse is also true: access denied to the general public may also be denied to the press, but the government may not close down avenues for gathering and acquiring news that are generally available to the public, without a compelling reason. See *Pell v. Procunier*, 417 U.S. 817 (1974); *Saxbe v. Washington Post CO.*, 417 U.S. 843 (1974); *Houchins v. KQED*, 483 U.S. 1 (1978). See also Rita Ann Reimer, Library of Congress, Congressional Research Service, "Legal and Constitutional Issues Involved in Mediasat Activities," CRS Report No. 86-823A, 1987, pp. 6-8. When the United States invaded Grenada in 1983, the government imposed a total news blackout and prohibited members of the public and the press from traveling to Grenada. The press sought prospectively to enjoin the Executive from imposing any such future ban. The case was dismissed as moot, but the court went on to say that "[the] decision whether or not to impose a press ban during military operations and the nature and extent of such a ban if imposed are matters that necessarily must be left to the discretion of the commander in the field." *Flynt v. Weinberger*, 588 F. Supp. 57,61 (D.D.C. 1984) affirmed (on the basis of mootness), 762 F.2d 134 (D.C. Cir. 1985).

<sup>91</sup>U.S. Congress, Office of Technology Assessment, *Science, Technology, and the First Amendment*, OTA-CIT-369 (Washington, DC: U.S. Government Printing Office, January 1989), pp. 9-10. In July 1987, the Department of Commerce issued a final regulation for licenses for private ownership of satellites such as Mediasat, which is owned by the electronic and print news media, on national security grounds. See Ramon L. Lopez, "Remote Sensing and the Media," *Space Markets*, Autumn 1987, pp. 148-151.



### ***Maintaining Internal Security and Social Welfare***

To maintain internal stability and social welfare, government must provide for law and order, collect revenue, and administer programs. The growth in the number and scope of these activities has been accompanied by the growth of an administrative state.<sup>92</sup> The large bureaucracies that carry out these activities are organized in a hierarchical fashion and operate in accordance with set rules and procedures. To perform internal security and social welfare activities, the collection, retention, and exchange of information on individuals is critical.

To assure that such practices are consistent with democratic ideals, agencies are required to perform these functions in accordance with the principles of limited government and government accountability. In the American Federal system of government, these principles require that power be shared among Federal, State, and local agencies. Thus, most social welfare programs, while funded primarily at the Federal level, are administered at the State or local level. In addition, in carrying out its functions, the government must respect individual rights such as the right to freedom of expression, the right to privacy, and the rights of the accused.

Before large-scale computerization of agency record systems, the information gatekeepers, in carrying out internal security and social welfare functions, consisted primarily of the government bureaucrats in the Federal and State operating/line agencies, and individual citizens themselves. Individual citizens were able to perform this gatekeeping function because the difficulties involved in transmitting data from manual record systems via the post and telephone constrained agency exchanges of information.

Advances in computer and communication technologies have greatly transformed this situation. Today, computers linked to telecommunication networks have become central to modern law enforcement, revenue collection, and program administration. Enhancing the government's ability to communicate nationally on a real-time basis, these systems are being used to store, retrieve, manipulate,

and exchange billions of pieces of data necessary for investigations, audits, histories, etc. In the process, individual citizens have lost control over information about themselves.

To understand how these developments might affect the realm of government, two rapidly growing technological applications will be considered here: networked computerized information systems and online financial systems.

### **Networked Computerized Information Systems**

Telecommunication linkages between and among government agencies allow for direct online inquiries from one agency terminal to a computerized database of another agency. Although online databases are electronically linked and therefore are distributed in a physical sense, they constitute a centralized database in a practical sense. As computer and telecommunication costs decrease, more and more agencies will automate their files and have the capability to communicate online, allowing this virtual centralized database to grow.

A number of computerized databases are now accessible online. The Federal Bureau of Investigation's (FBI's) National Crime Information Center (NCIC), for example, has a number of computerized files, including the Interstate Identification Index (Triple I). The Department of the Treasury has developed an online system, the Treasury Enforcement Communications System (TECS), for identifying people coming into the country. Both the Immigration and Naturalization Service and the Social Security Administration maintain a number of databases that other government agencies can access electronically. Additionally, private sector firms, such as credit bureaus and medical insurers, maintain a number of centralized databases that are accessible by government agencies.<sup>93</sup>

These networked computerized information systems have created a de facto national database, maintaining up-to-date and complete information on all individuals. Using such a system, the Federal Government could centralize control at the expense of State and local agencies. Moreover, it could use these networked systems for surveillance purposes

<sup>92</sup>See Beniger, *op. cit.*, footnote 3; and Stephen Skowronek, *Building a New American State* (Cambridge: Cambridge University Press, 1982).

<sup>93</sup>U.S. Congress, Office of Technology Assessment, *Federal Government Information Technology: Electronic Record Systems and Individual Privacy*, OTA-CIT-296 (Springfield, VA: National Technical Information Service, June 1986).

to exercise more subtle and invisible means of control over citizens, thereby shifting the relationship between the government and the governed. And decisions about the scope and use of networked computerized systems could be driven by technological possibilities rather than by program needs, so that the costs of the systems exceed their benefits.

Yet, under some circumstances, the networking of computerized information systems could benefit individuals in several ways. In fact, this kind of networking could allow people to have more control over information exchanges. Individuals could access their own records through online networked systems, and perhaps even prevent unnecessary exchanges of information. If agencies were required to do cost/benefit analyses before network systems were deployed, these systems might also increase the efficiency of government operations. Moreover, if standards were established for record quality, inaccurate and incomplete information could be purged from agency files.

How such systems will operate in practice will depend on a number of factors. The design of the systems will, of course, be critical; for systems can be constructed to foster either centralization or decentralization of data. In the case of the NCIC and the National Driver Register, for example, policymakers gave primary control to the States by deliberately designing the system to serve as an index for the State systems. Thus the NCIC's Triple I contains only the names and locations of files—the actual content of the records is maintained by the FBI or State agencies. This design preserves State control over its records, while allowing other States and Federal agencies to become cognizant of additional records.<sup>94</sup>

The quality of the data in the systems is also a critical factor in their operation. Setting quality standards would assure that the data contained in agency databases are accurate, timely, and complete. Without a way to judge the reliability of database information, agencies will have to spend considerable time verifying it. Setting quality standards is particularly important with respect to collecting information about individuals, who may be unaware

that data about them are being compiled. The need for such standards has been formally recognized in the Privacy Act of 1974, which establishes requirements for data quality. The Federal Government might also influence the quality of data, and the care with which they are treated, through financial incentives. For example, the funding of such networks could be made contingent on the adoption of particular standards or the use of specific software.

A third important factor in determining the system's effects on maintaining internal security and social welfare are the rules for gaining access to data contained in it. The fact that systems are, or can be, networked should not drive decisions about who should use them, and for what purposes. Privacy, national security, and program integrity may all be legitimate reasons for limiting access.

### Automated Financial Transaction Systems

Today, there are more than 70 different Federal benefit programs that provide care, goods, and services to people who meet eligibility requirements based on income level or need. Almost 75 percent of these programs are funded by the Federal Government, with funding for the remainder provided by States and localities. These programs are generally administered at the State and local levels in accordance with Federal guidelines that may be very detailed or quite general.<sup>95</sup>

Although the processes by which these programs are administered can vary significantly, there are five steps that are more or less common to them all. These are:

1. determining eligibility and benefits;
2. verifying the eligibility of recipients;
3. issuing benefits;
4. verifying the receipt of benefits; and, in some cases,
5. redeeming benefits.

Because these steps all entail the storage, retrieval, and exchange of information, each could be automated using state-of-the-art communication and information technologies. With automation, for example, tax authorities could electronically collect financial records from banks, employers, investment

<sup>94</sup>U.S. Congress, Office of Technology Assessment, *An Assessment of Alternatives for a National Computerized Criminal History System*, OTA-CIT-161 (Springfield, VA: National Technical Information Service, October 1982).

<sup>95</sup>The major types of benefit programs include: medical (e.g., Medicaid and Maternal and Child Health Services); cash (e.g., Aid to Families With Dependent Children (AFDC) and Supplemental Security Income (SSI)); food (e.g., Food Stamp and School Lunch Programs); housing (e.g., "Section 8" and public housing); education (e.g., student loans); jobs and training (e.g., under the Job Training Partnership Act); and energy assistance.

houses, and mortgage lenders; determine a person's tax assessment; and then electronically credit or debit his or her account. In similar fashion, government agencies could employ new technologies to electronically deliver public assistance benefits such as cash, food stamps, and Medicaid benefits.

There are at present a number of pilot projects automating the issuance and/or redemption of public assistance programs. For example, New York State has established an Electronic Medicaid Eligibility Verification System in order to verify, at the time of issuance, clients' eligibility for certain treatments or medications. And Ramsey County, MN, has begun to use automatic-teller machines and point-of-sale terminals to issue cash for certain public assistance programs.<sup>96</sup> The impetus to take advantage of such systems is likely to mount in the future, given growing concerns about government expenditures, fraud, waste, and program abuse.

Automated financial transaction systems that would provide such capabilities could be devised as online systems in which a real-time communication link to a centralized database is used to make a transaction. Or they can be systems constituted of smart cards containing a microchip that can be inserted into a read/write terminal to conduct a transaction. Both systems require a reliable and secure identity card with a unique personal identifier. Some systems, however, might be designed to be dedicated to a specific government program, while others might be setup to be used by more than one program or in conjunction with commercial systems.

Automated systems could help to streamline the administration of government programs, while improving the accuracy and completeness of financial records. However, if they are poorly instituted, these systems could easily deteriorate to become bureau-

cratic mazes where the lines of authority among program officials and between the public and private sectors are very unclear. And, without clear lines of authority, such systems could not be held publicly accountable.

One factor that will affect the costs, use, and impact of automated transaction systems is the technological choice about how these systems should be devised. Although online systems are less costly than smart cards and could be more readily put into place, they are also more vulnerable and are subject to counterfeiting. Choosing the technology is also complicated by problems of technological uncertainty. The technology is changing so rapidly that, even if the government were to begin now to deploy online electronic systems using magnetic stripe cards, these systems might become obsolete before they are fully implemented. On the other hand, a commitment now to a microchip smart-card system might be premature not only for technical reasons, but also because as yet there is no commercial basis for such a system in the United States.

Careful consideration will also need to be given to the privacy and security implications of using such automated systems, since their development and widespread deployment will result in the establishment of a de facto national database. At a minimum, the operation of such systems would have to comply with the requirements of the Privacy Act of 1974<sup>97</sup> and the Computer Security Act of 1987.<sup>98</sup> In addition, proposals for establishing an electronic system for distribution and redemption of public assistance benefits, which depend on the use of a magnetic stripe card or smart card, would give rise to concerns about the adoption of a national identity card. Americans have traditionally been adamant in their opposition to the use of a single identity card, associating it with authoritarian forms of government.<sup>99</sup> This concern would loom particularly large

<sup>96</sup>For a discussion, see U.S. Congress, Office of Technology Assessment, *Electronic Delivery of Public Assistance Benefits: Technology Options and Policy Issues*, OTA-BP-CIT-47 (Springfield, VA: National Technical Information Service, April 1988).

<sup>97</sup>Personal information in Federal agency databases receives some protection under the Privacy Act of 1974, which gives individuals certain rights to exercise some control over the content and uses of personal information about themselves. They have the right, for example, to see and correct information, and to challenge secondary uses of that information. The act also requires agency staff to handle personal information in a manner consistent with individual privacy. Thus, they must ensure that information is current and accurate, that it is collected directly from the individual, and that adequate safeguards are provided to prevent its misuse. To ensure agency compliance with these principles, the act lets individuals bring civil and criminal suits in cases where information was willfully and intentionally handled in violation of the act. In addition, the Office of Management and Budget was assigned responsibility for overseeing agency implementation of the act.

<sup>98</sup>The Computer Security Act of 1987 assigns to the National Institute of Standards and Technology the responsibility for developing technical, management, physical, and administrative standards and guidelines for the security of sensitive information in Federal computer systems, and for developing guidelines for training in security awareness and practice for personnel operating Federal computer systems.

<sup>99</sup>The most recent national debate on the creation of an identity card took place in the early 1980s. It was generated by a proposal of the Select Commission on Immigration and Refugee Policy to create an employee-identification card.

if the Social Security Administration were included in a national, automated system. Moreover, if the card were used only by those participating in benefit programs, it might be opposed on the grounds that it stigmatized an economic and social subset of the population.

### *Providing for Openness*

In the United States, open communication is considered to be fundamental to maintaining democracy, as is indicated by the first amendment's protection of freedom of speech and press. At the very least, openness requires a two-way flow of information from the government to the public and from the public to the government. Openness will truly flourish, however, only when there is an active exchange and debate of information and ideas—what Justice Holmes termed a “marketplace of ideas.” As Holmes said:

The ultimate good desired is better reached by free trade in ideas—that the best test of truth is the power of thought to get itself accepted in the competition of the market.<sup>100</sup>

The primary gatekeeper mediating the exchange of messages between government and citizens and providing a forum for the “marketplace of ideas” has been the traditional press—daily newspapers, national magazines, radio, and TV networks.<sup>101</sup> Because the press has played such an important gatekeeping role,<sup>102</sup> a number of rules and regulations have been adopted that establish its rights and responsibilities. The first amendment recognizes the watchdog role of the press and thus protects it against prior restraint, libel, etc. The Fairness Doctrine requires that broadcasters meet a “public trustee” standard by allowing the public to respond to broadcasts involving personal attacks or political editorials. The press has also benefited from the

Freedom of Information Act, which requires agencies to make nonclassified records available on request. In addition, there are rules restricting concentration of media ownership, which are designed to maintain diverse sources of information.

New technologies directly affect these points of public access, and hence they will help to determine how open the American political system will be. Two new technological applications are considered here: the use of satellites by local and regional news outlets, and the political uses of electronic bulletin boards.

### **Use of Satellites for Local and Regional Newsgathering**

New satellite technology and portable transmission equipment have made it possible for television stations to videotape news events, relay them to a satellite, and then transmit them to receiving stations for direct broadcast or editing so they can be included in a later newscast. To do this, stations use Ku-band satellites and a van with video equipment, together with a dish that allows the van to send and receive TV signals via satellite.

Network television no longer serves as the primary gatekeeper covering public events.<sup>103</sup> Using satellite technology, for example, Cable Network News, other news stations, and local network affiliates can now send their own crews to cover stories. There are, moreover, a number of news services, such as Conus's Washington Direct, that use satellite technology to feed members of their cooperative live, unedited coverage of events and press briefings from the Nation's capital. Taking advantage of these services, local stations may have access to more sources of news, and may also find it easier to cover national and international news with a local slant.<sup>104</sup> Ideally, local viewers will be able to

<sup>100</sup>*Abrams v. United States*, 250 U.S. 616, 630 (dissenting).

<sup>101</sup>Additionally, Federal agencies and depository libraries have been important gatekeepers for disseminating public information. See U.S. Congress, Office of Technology Assessment, *Informing the Nation: Federal Information Dissemination in an Electronic Age, OTA-CIT-396* (Washington, DC: U.S. Government Printing Office, October 1988).

<sup>102</sup>See Laurence Parisot, “Attitudes About the Media: A Five Country Comparison,” *Public Opinion*, January/February 1988, pp. 18-19, 60; Robert MacNeil, “The Mass Media and Public Trust,” Occasional Paper No. 1, Gannett Center for Media Studies, April 1985; and “The Media and the People: Americans' Experience with the News Media: A Fifty-Year Review,” Gannett Center Working Paper, 1985.

<sup>103</sup>See “The Futurist i. Charge at NBC News” (interview with NBC News President Larry Grossman), *Broadcasting*, Feb. 29, 1988, pp. 44-54; Alfred J. Jaffe, “Early News Surge Continues,” *Television/Radio Age*, May 16, 1988, pp. 39-40; David G. Shaffer, “By Van and Satellite, Local Newscasts Are Going National,” *The New York Times*, Dec. 21, 1986; Eliot Tiegel, “Independents Find News Niches,” *Television/Radio Age*, Jan. 25, 1988, pp. 70-71, 99-100; and “The Business of News,” *Gannett Center Journal*, vol. 1, No. 1, spring 1987.

<sup>104</sup>In less than 10 years, the number of Press members in the Senate Radio and TV gallery has grown from 750 in 1979 to over 2,300 in 1987 (3:1 ratio of support personnel to correspondents). See Howard Fields, “D.C. Crowded As Stations Elbow In For News Feds,” *Television/Radio Age*, Sept. 14, 1987, pp. 51-52, 84; and Dan Tuden, “Hometown TV Coverage Is Booming,” *National Journal*, Aug. 29, 1987, pp. 2174-2175.

watch national and international news with an analysis of how events affect their local area.

Notwithstanding these potential benefits, some fear that widespread use of satellite newsgathering will reinforce the trend of treating “news as entertainment.”<sup>105</sup> Others are concerned about the loss of network control and its effect on the role of the news media in shaping a national agenda. As a former vice president and director of news for CBS asked:

Are the networks soon to become a kind of electronic Associated Press, simply feeding stories to affiliates who will then repackaging them in their own newscasts?<sup>106</sup>

Some are concerned that the cost of satellite uplinks may lead to further concentration in the industry. At present, a number of satellite newsgathering services have developed to compete with the networks in selling feeds to local and regional stations, among them Hubbard’s Conus, Turner’s CNN, Westinghouse’s Newsfeed, and the Chicago Tribune’s Independent News Network.<sup>107</sup> However, in covering certain events, such as the 1988 national political conventions, there may be too many vans and not enough transponder time, which may lead to further cooperative action in purchasing satellite time and sharing vans on location.<sup>108</sup>

The role of satellite systems in delivering the news will depend in part on the conditions and rules of access to them. If, for example, access to satellite uplinks is very expensive, some stations will probably be excluded. Access could also be limited due to geographic location.

Regulatory policies will also determine access to satellite uplinks. In the fall of 1987, the FCC relaxed restrictions governing the use of transportable Earth stations, which eased operations for satellite newsgathering vehicles. Previously, FCC licenses had required 5 days’ notification of intent to use a

transportable uplink. However, networks, independents, and associations argued that “news” does not give such notice. Agreeing, the FCC began to allow operations without notifications within a reasonably small geographic area.

If competition among news programs were to become greatly accelerated, advertisers might play a greater role as information gatekeepers, in some cases even dictating programming. Under such circumstances, networks and affiliates might be more reluctant to air straight political material, such as Presidential speeches or news conferences, as proved to be the case when President Reagan delivered his February 1988 speech on Contra aid.<sup>109</sup> Under highly competitive circumstances, gaining a percentage point becomes more important than preserving the integrity of political events. Such a conflict took place, for example, during the 1980 election when the race to be first led the networks to project Ronald Reagan as the winner even before the polls on the west coast had closed.

### Electronic Bulletin Boards

To effectively champion one’s views, individuals do not just act alone; they act in concert. The new technologies, with their capabilities to store, manipulate, retrieve, and network, are optimally suited to help them in this regard. With a personal computer and a modem, individuals can collect and store information related to their concerns; they can maintain lists of potential supporters and contributors and target specific messages to them; they can match organizational resources with organizational needs; and they can gain constant feedback about the progress being made. Figure 6-4 illustrates, for example, how the new technologies can be used to manipulate and structure information in a way that will improve both the efficiency and effectiveness of a political campaign.

<sup>105</sup>See Altheide, *op. cit.*, footnote 50; Leo Bogart, “Television News as Entertainment,” Percy H. Tannenbaum, *The Entertainment Functions of Television* (Hillsdale, NJ: Lawrence Erlbaum Associates, 1980); and K. Lang and G.E. Lang, *Politics and Television* (Chicago, IL: Quadrangle, 1968).

<sup>106</sup>Burton Benjamin, “Technology and the Bottom Line Create Profound Challenges,” *The New York Times*, Aug. 17, 1986.

<sup>107</sup>*Ibid.*

<sup>108</sup>“SNV’s t. Play Major Role in 1988 Campaign Coverage,” *Broadcasting*, July 20, 1987, pp. 46, 48, 52.

<sup>109</sup>“White House Faults Networks for Skipping Reagan Speech,” *Broadcasting*, Feb. 8, 1988, pp. 113-114. There are other times when network needs dictated scheduling of Presidential speeches. In February 1978, CBS delayed President Carter’s address on ratification of the Panama Canal treaty because it had a made-for-TV movie scheduled. President Reagan’s 1986 State of the Union speech was delayed because of the Challenger disaster and had to be rescheduled during the first week of February, which is also the time for the network ratings sweeps. To avoid interfering with scheduled programs (e.g., NBC’s Peter the Great miniseries), President Reagan began his speech an hour earlier, which required passage of a joint resolution of Congress. This meant the people on the west coast were still at work during the President speech, and resulted in more people watching the Democratic response to it.

**Figure 6-4-Development of Custom Targeting Database**

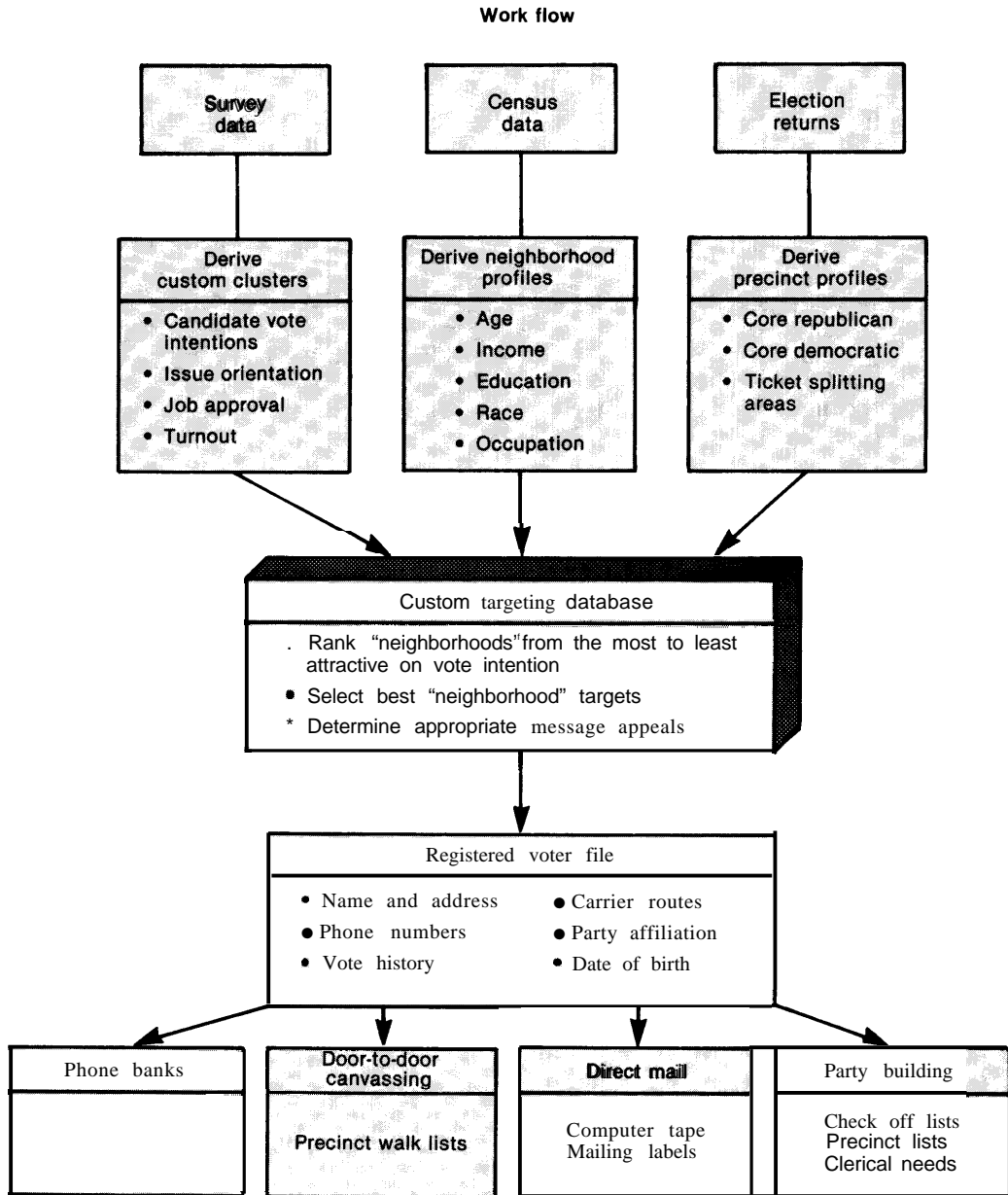

SOURCE: Kevin L. Kramer and Edward J. Schneider, "Innovations in Campaign Research, Finding the Voters in the 1980s," Robert G. Meadow (ed.), *New Communications Technologies in Politics*, (Washington, DC: The Annenberg Washington Program, 1985), p. 24. Reprinted with permission.

One does not need to be a seasoned political activist to take advantage of these new capabilities.<sup>110</sup> Acting on his own, one man in Colorado Springs, for example, led a successful campaign to block a local ordinance placing restrictions on home-based entrepreneurial activities. Surprised that he was the only citizen to attend the first hearing on the ordinance, he brought the issue to the community's attention by publishing it, together with a list of his concerns, on his computer bulletin board. A small notice in the local newspaper helped to advertise his plan. A number of people contributed their comments via the computer bulletin board. When a second hearing was held several weeks later, 175 people appeared to defeat the ordinance.<sup>111</sup>

To provide citizens with a new means of learning about government activities, some electronic bulletin boards have been established by State or local governments. In May 1987, for example, the Utilities and Commerce Committee of the California State Assembly set up an electronic bulletin board system, "The Capitol Connection," which enabled participants to learn about legislative and regulatory issues and to engage in debate with other participants on these issues.<sup>112</sup> Accessible via four telephone lines, forums were set up to comment on various pieces of legislation. Although this bulletin board had about 1,000 registered users, it was recently discontinued for lack of funding.<sup>113</sup>

These experiences illustrate how electronic bulletin boards could give rise to new electronic communities, promoting discussions and the exchange of information on a range of public issues. Moreover, with software that provides text on demand as well as sophisticated graphics, bulletin boards could lower the barriers of entry into the world of publishing. In addition, by taking advantage of the interactive nature of this technology, individuals could also use electronic bulletin boards to become

their own media gatekeepers, structuring the content of the information they receive.<sup>114</sup>

But the deployment and use of electronic bulletin boards for political purposes could also have some less positive effects. Not only will new groups be established outside of traditional political channels; within existing groups, there is likely to be a shift in the chain of command. In addition, to the extent that electronic bulletin boards are employed to target specific people, they could lead to the fragmentation of the body politic.

The rules and conditions governing access will be a major factor affecting the impact that electronic bulletin boards have on political life. Access, for example, could be limited by the costs of such systems or by the lack of skills to use them. Some groups have sought to address these problems by making computer terminals available in public places. For example, the Community Memory Project in Berkeley, CA, installed public access terminals in a food cooperative, cultural center, and community store.<sup>115</sup> Similarly, recognizing the importance of public access to such systems, Assemblywoman Gwen Moore introduced legislation into the California State Legislature designed to make computer terminals more widely available in public libraries.<sup>116</sup>

For electronic bulletin boards to be widely accessible, they must be able to interconnect with the public telecommunication network and/or with private networks. The development of, and agreement on, standards is therefore also important.

Ownership of systems, registration requirements, and system gatekeepers will also be important determinants of the openness of such communication systems. Thus, a number of questions will need to be answered with respect to rules of access and use:

<sup>110</sup>For a primer on how to use such systems to achieve political objectives, see Pacific Bell, *Electronic Citizenship*, October 1988.

<sup>111</sup>Dave Hughes, "The Neighborhood ROM, Computer-Aided Local Politics," *Whole Earth Review*, vol. 45, March 1985, p. 89.

<sup>112</sup>David W. Batterson, "The Capitol Connection," *Computer Currents*, Aug. 25, Sept. 7, 1987, p. 20; and Mary Eisenhart, "California Lawmakers M@ the Electronic Age," *Microtimes*, February 1988, p. 118.

<sup>113</sup>Personal communication, Robert Jacobson, consultant to the California Assembly Utilities and Commerce Committee, Feb. 5, 1988.

<sup>114</sup>A survey of users of a political computer bulletin board system, *The Political Forum*—located in a university community near a State capitol and carrying two interactive programs, Messages and Issues, in which a State senator provides a weekly legislative update—revealed that overall use was motivated equally by surveillance (finding out what was going on), personal identity, and diversion. See Gina M. Garramone, Allen C. Harris, and Ronald Anderson, "Uses of Political Computer Bulletin Boards," *Journal of Broadcasting & Electronic Media*, vol. 30, No. 3, Summer 1986, pp. 325-339.

<sup>115</sup>"New CM Network Gets Good Response," *Community Memory News*, No. 2, pp 1-2, 7.

<sup>116</sup>"State Assembly Experiments with 'Electronic Democracy' via Computer Bulletin Board, 'The Capitol Connection.'" Press release from California Assemblywoman, Gwen Moore, Sacramento, CA, May 27, 1987.

- Should anyone be allowed to get on a bulletin board?
- Would open access on such a scale lead to problems of information overload?
- Are there ways to set quality standards for content or provide some form of evaluative review?
- How are agendas set, and who has the authority to set them?

### *Providing for Participation*

Classical political theory posits that a democracy exists when all citizens actively participate in public affairs. In reality, all democracies limit citizenship and the ways in which citizens can participate in politics.<sup>117</sup> In addition, people differ with respect to the ways and the extent to which they participate, depending on estimations of their own effectiveness.<sup>118</sup>

Although direct participation is possible—through letter-writing, visits to government officials, testifying at meetings, demonstrations, and running for elected office—most participation is indirect, as in the case of voting for representatives.<sup>119</sup> This indirect participation has been mediated primarily by political parties and interest groups, both of which articulate and aggregate preferences, recruit members and candidates for political office, persuade voters and government officials, and disseminate information on public issues.<sup>120</sup>

Allowing people to circumvent parties and interest groups, new communication technologies are certain to affect the American political system and how people participate in it.<sup>121</sup> Two applications are examined here: the use of cable television to target potential voters, and the use of networked computer systems in political campaigns.

### **Use of Cable Television to Target Potential Voters**

In political campaigns, advertising has been a traditional mechanism for persuading voters. Campaigns have advertised in newspapers, on radio, and on television. Between 1980 and 1988, the total cost of running Senate and House campaigns has almost doubled, from \$239 million to an estimated \$540 million. A significant proportion of this increase has gone to advertising, as can be seen in table 6-4.<sup>122</sup>

With programming provided by cable channels now accounting for 33 percent of total viewing among cable households, this medium has become a very cost-effective means by which advertisers can target political messages to specific audience groups. Not only has the cable audience increased considerably over the last several years; in addition, of all television viewers, cable viewers are the most politically active. The Cabletelevision Advertising Bureau notes, for example, that according to some studies:

Cable subscribers are 26 percent more likely to support a political group or a candidate than non-cable viewers. By a 30 percent margin, cable subscribers are more likely to engage in political fundraising; they are 36 percent more likely to be involved in local issues, 56 percent more likely to have personally visited an elected official in the past year and 34 percent more likely to have expressed an interest in writing to public officials.<sup>123</sup>

Moreover, a candidate's message can be targeted to specific geographic and demographic audiences. As Sabato and Beiler describe this advantage:

The process of "targeting" involves cross-referencing polling and census data to enable a campaign to send key voters the precise message they want to hear. Until recently that has meant

<sup>117</sup>See Carole Pateman, participation and Democratic Theory (Cambridge, MA: Cambridge University Press, 1970); and Benjamin Ginsberg, *The Consequences of Consent* (New York, NY: Random House, 1982).

<sup>118</sup>Angus Campbell, Phillip E. Converse, Warren E. Miller, and Donald E. Stokes, *The American Voter* (Chicago, IL: The University of Chicago Press, 1960); and Herman H. Nie, Sidney Verba, and John R. Petrocik, *The Changing American Voter* (Cambridge, MA: Harvard University Press, 1976).

<sup>119</sup>Sidney Verba and Norman H. Nie, *Participation in America—Political Democracy and Social Equality* (New York, NY: Harper and Row, 1972).

<sup>120</sup>Political parties can be distinguished from interest groups by the broader base of their membership and their much greater role in structuring elections. See Clinton Rossiter, *Parties and Politics in America* (Ithaca, NY: Cornell University Press, 1960), for an account of political parties in the United States. For a general account of the role of interest groups, see Jeffrey M. Berry, *The Interest Group Society* (Boston, MA: Little Brown, 1984).

<sup>121</sup>For a collection of articles and materials relating to this subject, see Joel M. Swerdlow (ed.), *Media Technology and the Vote: A Source Book* (Boulder, CO: The Westview Press, 1988).

<sup>122</sup>According to Curtis Gans: "In 1974, the average overall cost per vote was 67 cents. In 1984, it was \$7.74. In 1974, the average media cost per vote was 12 cents. In 1984, it was \$3.54. Overall campaign costs have increased since 1974 about fivefold. Media costs have increased tenfold." As cited in Swerdlow (ed.), op. cit., footnote 121, p. 81.

<sup>123</sup>Lloyd Trufelman, "Audio/Visual Targeting Through Cable Television," *ibid.*, p. 27.



Table 6-4--Political Advertising on Television

Year	Network	Spot/local	Total
1970	\$260,900	\$11,789,000	\$12,049,900
1971	30,000	5,490,000	5,520,000
1972	6,519,100	18,061,000	24,580,100
1973	1,199,000	7,865,800	9,064,800
1974	1,466,200	21,781,600	23,267,800
1975	1,744,200	6,251,000	7,995,200
1976	7,906,500	42,935,700	50,642,200
1977	—	14,992,600	14,992,600
1978	1,065,800	56,545,000	57,610,800
1979	255,000	16,891,700	17,146,700
1980	20,699,700	69,870,300	90,570,000
1981	713,100	20,114,300	20,827,400
1982	861,900	122,760,300	123,622,200
1963	2,739,700	24,609,700	27,349,400
1964	43,652,500	110,171,500	153,824,000
1985	—	22,680,500	22,680,500
1986	459,300	161,164,000	161,643,300
1987	.	24,923,200	24,923,200
1988	38,520,700	189,379,500	227,900,200

SOURCE: Television Bureau of Advertising, Broadcast Advertisers Reports. Spending figures compiled by the National Association of Broadcasters. Reprinted with permission of the Television Bureau of Advertising.

defining demographic “clusters” that react with supposedly predictable political behavior, identifying their geographic presence and then exposing them to highly specific and often dramatic direct mail... Cable services are becoming more segmented, but the expanding scope of system “interconnects”--computer networks organized by groups of local cable systems that can facilitate placement of messages innumerable demographically homogeneous communities simultaneously--will further “fine tune” the audience. The cost Per thousand viewers is as much as one-third lower than the shotgun approach of network television.<sup>124</sup>

Given this ability to offer the visual and audio impact of mass media advertising with the specificity of point-to-point communication, one media lawyer has characterized cable advertising “as a perfect merger between TV and direct mail.”<sup>125</sup>

Another attractive feature of cable is its flexibility. Cable stations accept longer advertising spots than do broadcast stations, allowing candidates to prepare personality profiles or pieces on specific issues.

Although cable companies have only recently targeted political candidates as a new source of advertising revenues, as early as the 1960s they recognized that political candidates were potential advertisers. In 1968, Presidential candidates were, for the first time, given free time on cable, and the National Cable Television Association (NCTA) urged them to take advantage of cable’s special features.<sup>126</sup> In 1987, the Cabletelevision Advertising Bureau and NCTA held a workshop on Capitol Hill designed to promote political advertising on cable. More recently, focusing on their targeting advantage, some cable systems and/or cable programmers are now designing systems in which messages can be addressed to a particular viewer.

Assessments of how cable advertising might affect American politics differ markedly. Noting that American politicians have only rarely been able to directly engage the electorate, Frank Luntz, in his evaluation, emphasizes how television and television advertising now permit political figures to do it. As he says:

Integration of television into the political environment in the 1960s and 1970s enabled candidates, for

<sup>124</sup>Larry Sabato and David Beiler, “Magic ... or Blue Smoke and Mirrors? Reflections on New Technologies and Trends in the Political Consultant Trade,” Swerdlow (ed.), op. cit., footnote 121, pp.7-8.

<sup>125</sup>John Wolfe, “Tossing Its Hat Into Political Ad Ring,” *Cablevision*, Feb. 1, 1988, p. 31; and “Cable Delivers the Electorate, Says Panel,” *Broadcasting*, Jan. 15, 1988, pp. 76-77.

<sup>126</sup>Ithiel de Sola Pool and Herbert E. Alexander report, in “Politics a Wired Nation,” Ithiel de Sola Pool (ed.), *Talking Back: Citizen Feedback and Cable Technology* (Cambridge, MA: MIT Press, 1973), that: “Both the Nixon and Humphrey campaigns made organized efforts to solicit cablecasters to present their candidates. The Nixon campaign reported that 415 systems with a potential audience of 4.7 million people carried the Republican materials, while the Humphrey campaign reported that 303 cable systems representing a potential audience of 3.5 million people earned the Democratic materials.”

the first time, to appear in bodily form, in the homes of constituents. In the next decade, the typical statewide campaign will spend at least half of its dollars on political advertising, and will reach more voters more often with more information. Although still far away in Washington, DC, elected officials have become less obscure and more accountable figures. . . . Television advertising has given many American voters the ability to recognize the candidates' names and faces—and learn something about the background of the people they are electing.<sup>127</sup>

Alternatively, others view cable advertising as providing one more device for media professionals to more effectively “market” their candidates, a development that they fear can only serve to make political figures more, and not less, remote from the general public. As voiced by former Senator Charles McC. Mathias:

Under the current system, few candidates relish the task of getting elected. There is increasing awareness that modern campaign technologies have fostered a remoteness from the voters . . . . The expertise of campaign professionals—political consultants, media advisors, pollsters, direct mail specialists—lies in the technique of mass marketing, not in fostering personal contact between candidates and the voters.<sup>128</sup>

There is also concern that cable's targeting ability might serve to fragment the body politic. Because politicians can vary their messages according to what particular audiences may want to hear, voters may be less informed about alternative points of view, and less inclined to consider their own opinions in light of a larger, national context.

Cable targeting may also reduce the politicians' dependency on traditional political information gatekeepers—in particular the press and political parties—a development that could have major consequences for public policy. As Swerdlow notes:

Public policy is closely tied to this fragmentation. Politicians and public officials, following the lead of advertisers promoting goods and services, now target messages at groups such as DINKS (double income, no kids). This is far different than address-

ing Democrats or Republicans or conservatives or liberals, and is becoming the best way to mobilize voters in modern America.<sup>129</sup>

How cable advertising will affect American politics will depend on the development of the technology and its strength of appeal among media buyers. It will also depend on the costs of campaigning and the nature of campaign financing rules, as well as on the ability of parties, the press, and other media to continue to play their traditional political gatekeeping roles.

Success in using cable to target voters depends to a considerable degree on the quality of data employed. In the past, the demographic data about particular audiences within a specific cable system were fairly sketchy and often out of date. Lately, however, data have improved. NCTA has recently merged its databases, creating an online service that can identify cable advertising possibilities according to congressional district, together with demographic indexing and a list of current open ad slots.<sup>130</sup> As the quality of these tools increases so will their use by political media professionals.

Although media buyers in political campaigns are just beginning to recognize cable's potential, many are still unfamiliar with how to buy media time. Others are reluctant to use cable because they want to avoid the problems of having to make a number of different, separate deals with local franchises in order to buy time for a statewide or national race. In their efforts to attract political advertising, cable companies are now trying to alleviate some of these problems. To help media buyers plan and coordinate advertising for political candidates, a number of multiple system operators are planning to establish a nationwide “buyers service.”<sup>131</sup>

Campaign financing and campaign-financing laws will also affect how cable advertising impinges on democratic politics. With campaign costs skyrocketing, politicians will increasingly be inclined to seek out the most cost-effective means of influencing voters, such as cable advertising.<sup>132</sup> Limits on campaign expenditures might constrain the

<sup>127</sup>Frank Luntz, “Campaign Technology and American Democracy,” Swerdlow (ed.), op. cit., footnote 121, p. 100.

<sup>128</sup>As cited in *ibid.*, p. 94.

<sup>129</sup>Joel Swerdlow, “Fragmentation of the Electorate,” Swerdlow (ed.), op. cit., footnote 121, p. 107.

<sup>130</sup>Sabato and Beiler, op. cit., footnote 124, p. 9.

<sup>131</sup>Jeannine Aversa, “United Cable TV Among MSO's Considering Political Ad Service,” *Multichannel News*, Jan. 18, 1988, p. 4.

<sup>132</sup>It should be noted that under provisions adopted in 1972 to section 315 of the Communications Act, stations are to charge the “lowest unit rate” for political advertising. In the 1980s, this rule has not been diligently enforced by the FCC.

**amount** of money spent on political advertising.<sup>133</sup> However, it might also induce politicians to spend their limited advertising budgets on cable TV, since cable costs less per voter and is rapidly becoming equal to network TV in effectiveness, if not more so.

Whether or not cable advertising will serve to fragment the public and displace traditional gatekeepers will depend not only on what happens within the cable industry itself; it will also depend on the development of other media and the deployment of new technologies. Thus, it is evident that political parties have not remained passive in the face of technological change.<sup>134</sup> In many cases, they have assumed the role of technological expert, offering their incumbents and candidates high tech services to help them make their cases to the public. These services might include, for example, the development of computerized voter lists, targeted appeals to get out the vote, and even video and satellite facilities.<sup>135</sup> To the extent that traditional gatekeepers find new niches—and there remain a number of different, although equally effective, paths by which politicians and the electorate can communicate—the impact of cable targeting is likely to be diminished. On the other hand, to the extent that cable advertising proves to be far superior to other means of political communication, its impact on American politics is likely to be considerable. Under such circumstances, the government may want to assure that other effective communication pathways not only remain available, but can also be accessed in an equitable manner.

## Networked Computer Systems

All major and most minor political campaigns now use computers for scheduling, fundraising, speechwriting, demographic analyses, profiles on competitors, communication with field offices, direct mail campaigns, targeting swing voters, organizing volunteers, budgeting, and financial reporting to the Federal Elections Commission. Computer systems and software vary dramatically in sophistication and cost, with the price of campaign software packages ranging, for example, from \$135 to \$7,500. One political consultant estimated that in the 1985-86 congressional campaigns, about \$2 million was spent on software and about \$20 million on computer hardware, software, and services, including the purchase of voter lists.<sup>136</sup> It was estimated that by the spring of 1988, more than \$19 million had been spent in Federal campaigns on computer programs, voter lists, and computerized fundraising.<sup>137</sup>

In addition to using their own computer networks, campaigns also subscribe to online information services that allow them to follow and analyze not only coverage of their own campaigns, but that of others as well. One of the most ambitious of these services to date is the “Presidential Campaign Hotline,” which provides summaries of political news from electronic and print sources for a fee of \$150 to \$350 per month.<sup>138</sup> Subscribers include campaigns, new organizations, lobbyists, and political consultants who depend on this service for an “insider’s news summary.”<sup>139</sup> Hotline also offers “Campaign Reports,” an electronic bulletin board

<sup>133</sup>Although the power of money to influence campaigns and thus affect the outcome of elections is well documented, it has been difficult to fashion public policies to address this problem. All other democracies establish some regulation over the use, timing, and/or format of political advertising on television by, for example, allocating free time, limiting time and money that can be spent, and applying restrictions on format. In the United States, however, the Supreme Court has protected campaign contributions, treating them as being equivalent to “speech.” For discussions, see David H. Remes, “Memorandum on Constitutional Issues Raised by Proposed Restriction on Television Advertising in Federal Election Campaigns,” appendix to testimony of Curtis B. Gans, Vice President and Director, Committee for the Study on the American Electorate, before the Senate Committee on Commerce, Science and Transportation, Sept. 10, 1985, p. 12. See also J. Skelly Wright, “Money and the Pollution of Politics: Is the First Amendment an Obstacle to Political Equality?” *Columbia Law Review*, vol. 82, No. 4, May 1982, reprinted in *Political Economy and Constitutional Reform*, hearings before the U.S. Joint Economic Committee, 97th Cong., 2d sess., Nov. 9, 17, 18, and Dec. 15, 1982, p. 173.

<sup>134</sup>For a general discussion of how parties are adapting, see Paul S. Herrnson, *Party Campaigning in the 1980s* (Cambridge, MA: Harvard University Press, 1988).

<sup>135</sup>For a discussion, see *ibid.* See also Robert Blaemire, “The Party as Consultant,” *Campaigns & Elections Magazine*, July/August 1987, as reprinted in Swerdlow (ed.), *op. cit.*, footnote 121; and Stephen Frantzich, *Political Parties in the Technological Age* (New York, NY: Longman Satellite Communications, April 1988).

<sup>136</sup>John Aristotle Phillips, president, Aristotle Industries, as quoted in Elizabeth Tucker, “Computers Enter the World of Politics,” *The Washington Post*, Washington Business, Mar. 7, 1988, p. 9.

<sup>137</sup>Andrew Rosenthal, “Politicians Yield to Computers,” *The New York Times*, May 9, 1988, p. D5.

<sup>138</sup>For a description by this service’s founder, see Larry Checco, “The Presidential Campaign Hotline,” Swerdlow (ed.), *op. cit.*, footnote 121, pp. 21-25.

<sup>139</sup>Eleanor Randolph, “A Hot-off-The-Wire Service for Political Junkies,” *The Washington Post*, Oct. 11, 1987, pp. A18-A19.

for press secretaries, in which each candidate can run 200 unedited words.<sup>140</sup>

Networked computer systems could serve not only to make political campaigns more efficient and more responsive to citizen concerns; they could also make it easier for political candidates to network and share resources. Alternatively, these systems could increase the cost of political campaigns, enable politicians to manipulate citizens' perceptions, and make politicians more independent of political parties. The future role of such systems will depend, among other things, on who develops them, their costs, and their availability to all political contenders.

One important concern about the growing use of technology in politics is that it fosters the dependence of politicians on political consultants, rather than on political parties—a development that detracts from representative government. This concern derives from the fact that political consultants now play the pivotal role in engineering the use of new communication technologies in campaigns. As David Chagall describes in *The New Kingmakers*:

These consultants are high-powered professionals versed in the skills of polling, communication, and computer planning. They plot the strategies, set the stages, choose the themes, and mastermind the interplay of candidate and media in the Klieg lights of today's electioneering carnivals.<sup>141</sup>

Similarly, political scientist Benjamin Ginsberg argues:

The present-day change in the underlying strength of American political forces is a result precisely of the displacement of political party organizations by new mechanisms of electoral mobilization.<sup>142</sup>

Responding to the growing demand for political consultants, one university has established a Graduate School of Political Management. Political consultants have also formed their own trade association, the American Association of Political Consultants. Although in the past political consulting firms

were small, privately held, and often disappeared with the end of an election cycle, there are now 300 ongoing companies providing computer services for politics.<sup>143</sup>

To the extent that political consultants assume the role of political gatekeeping, their values, and the incentives that motivate them, become matters of public concern. Looking back at the history of recent electoral campaigns, some political observers have expressed concerns about the basic ethics of the consulting profession. In his study of political consultants, Larry Sabato concludes, for example, that they “are businessmen, not ideologues.”<sup>144</sup> Although they generally work for one particular party, political consultants tend to select the candidates they work for not on the basis of their viewpoints or world views, but rather on the “revenue-producing potential of a campaign.”<sup>145</sup> As characterized by one political consultant:

Democracy is a growth business. The industry is growing, and the reason is because there is more money being spent overall by campaigns.<sup>146</sup>

Others claim that the use of computer networks and high technology consultants actually contributes little to the prospects of a campaign, apart from increasing its overall costs. As described by journalist Fred Barnes:

It's partly fear that keeps consultants in demand, fear that your opponent will get a leg up. If one candidate hires a famous pollster or media consultant, the other candidates have to get expensive consultants of their own. In the end, the consultants nullify each other in most races. \*47

If campaign costs continue to escalate in response to each new technological development, some of the best candidates may be excluded from politics, while others may become increasingly beholden to political professionals rather than to political parties.

The role of political consultants in American political life will depend to a large degree on how effectively the traditional gatekeepers adapt to

<sup>140</sup>Marjorie Williams, “The politicians’ Instant Fix,” *The Washington Post*, Feb. 19, 1988, pp. B1-B2.

<sup>141</sup>David Chagall, *The New Kingmakers* (New York, NY: Harcourt Brace Jovanovich, 1981), p. 5.

<sup>142</sup>Benjamin Ginsberg, *The Captive Public* (New York, NY: Basic Books, Inc., 1986), p. 178.

<sup>143</sup>Andrew Rosenthal, “Politics Yield to Computers,” *The New York Times*, May 9, 1988, p. D1.

<sup>144</sup>Larry J. Sabato, *The Rise of Political Consultants* (New York, NY: Basic Books, Inc., 1981), p. 6.

<sup>145</sup>*Ibid.*

<sup>146</sup>Phillips, *op. cit.*, footnote 136, pp. 1, 9.

<sup>147</sup>Fred Barnes, “The Myth of Political Consultants,” *The New Republic*, June 16, 1986, reprinted in Swerdlow (ed.), *op. cit.*, footnote 121, p. 190.

the new technological environment. As Robert Blaemire has pointed out American political parties could employ new technologies to rebuild and revive the role of parties.<sup>148</sup> By taking advantage of new technologies to create voter databases, or to make video production facilities and satellite feeds available to candidates, the parties could position themselves to be the lowest-cost consultant to political candidates. In so doing, they would enhance their own roles as political gatekeepers. Being in control of political communication services, they would also be in a position to allocate their assistance not so much on the basis of a candidate's ability to pay, but rather on the basis of a candidate's political perspective, which would be more in keeping with democratic politics.

### *Providing for Representation*

*The* United States was designed to be a representative or republican form of government.<sup>149</sup> This design reflects the Founders' belief that, while government should be based on popular sovereignty, it should also protect the minority against majority rule. Thus, while power was given to the people, it was done in a limited, or restricted, fashion. Qualified participants were defined narrowly to include only white, property-owning males. Moreover, the President and Senate were not directly elected by the people, but rather were indirectly chosen by the Electoral College and the State legislatures. And finally, "the people" were themselves divided into two constituencies --one at the Federal and one at the State level.

In American politics, political parties have traditionally served as gatekeepers, providing a means by which representatives can organize their activities and constituents can hold representatives accountable. However, the widespread use of new technologies in politics is likely to disrupt this relationship, allowing individuals to circumvent their representatives and make their cases more directly. Although such a development might allow for a more direct form of democracy, it could also serve to further

fragment the body politic. To illustrate these possibilities, two technological applications are examined here: the televising of congressional proceedings and the polling of voters/constituents.

### **Televising Congressional Proceedings**

Televising congressional hearings began in 1948 with the Senate Armed Services Hearings on Universal Military Training and the House Committee Hearings on Un-American Activities. In both instances, committee members allowed television coverage to publicize both the substance of the issues and the role of committee members. Throughout the next 40 years, congressional committees allowed television coverage of a number of key hearings--the Kefauver hearings on organized crime in interstate commerce in 1951; the Army - McCarthy hearings in 1954; the Senate Watergate hearings in 1973; the House impeachment proceedings in 1974; and, most recently, the Iran-Contra hearings in 1987.<sup>150</sup>

The regular scheduling of congressional events did not begin, however, until much later with the development of cable television. In 1979, the Cable Satellite Public Affairs Network (C-SPAN), a non-profit cooperative of 40 or so cable TV companies, began covering the proceedings of the House of Representatives. In 1986, using C-SPAN H, coverage was extended to include Senate activities. To meet its annual budget of about \$12 million, C-SPAN receives its operating funds from the affiliate cable companies.

C-SPAN prides itself on its limited gatekeeping role. Although it selects subjects to be covered, it provides unmediated accounts in which the camera simply records the happenings, or the lack thereof, on the Senate and House floors. In addition, it provides full campaign coverage, and hosts a morning call-in program where candidates are questioned by the public. As Phil Roeder, Executive Director of the Iowa Democratic Party, describes C-SPAN's role:

<sup>148</sup>Blaemire, *op. cit.*, footnote 135, pp.171-173.

<sup>149</sup>There have been two competing theories of representation. The first, and the more widely accepted, is the trustee theory. According to this theory, the representative translates constituents' views into what, *from the representative's* perspective, is in the best interest of the country. The second theory, the delegate theory, argues that representatives should literally represent the views of their constituents.

<sup>150</sup>There was no problem in gaining access to the networks because, in each of these instances, the networks decided that there would be a substantial audience. Following each hearing, there was discussion of the effect that television coverage had with respect to the rights of the witnesses, the stance taken by congressional members, and the public's interest in the hearings. For a discussion, see Ronald Garay, *Congressional Television* (Westport, CT: Greenwood Press, 1988).

C-SPAN brings everything that the candidates are doing into the people's living rooms. It's the high tech version of retail politics.<sup>151</sup>

Although C-SPAN was virtually unknown when it began operation 10 years ago, it has gradually developed a loyal following, which includes a number of journalists and political junkies.<sup>152</sup> A 1987 survey commissioned by C-SPAN found that viewership had increased 43 percent since November 1984, from 7.6 million households to 10.9 million households.<sup>153</sup> Moreover, C-SPAN recently released a report claiming that its audience is competitive with MacNeil/Lehrer, Face the Nation, Meet the Press, and This Week With David Brinkley.<sup>154</sup>

Congressmen are also becoming more aware of C-SPAN and its potential impact on constituents. As Rob Stoddard has pointed out:

It was only a short time before members of Congress realized the power of the satellite-fed programming. Letters poured in from voters who had observed their congressman's actions on the floor or in an important hearing. And it wasn't long before House members began emphasizing issues important to them in speeches before an empty House chamber, merely to gain the exposure that C-SPAN offered.<sup>155</sup>

One positive outcome of televising congressional proceedings is that it could enhance the stature of Congress and its members, as well as revitalize the public's interest and participation in political affairs. Experience with C-SPAN has shown that live reporting of public events can also serve as an important source of information for traditional gatekeepers, such as party leaders and the press, helping them to monitor and keep track of events.

On the other hand, television coverage could serve to discourage substantive political debate if Congressmen chose either to posture before the public or to become more reticent. Moreover, with all their actions exposed to the public, Members may find it more difficult to arrive at compromise.

Television coverage might also detract from the idea of politics as public affairs by fostering the contrary notion of politics as entertainment.

One factor that will help to determine the impact of television coverage of politics will be the rules and norms that Congress establishes with respect to it. Both the House and the Senate control the cameras that cover floor activities, and they make the video feeds available to the media for their use. Cameras for hearings are supplied by the television stations, but the House and Senate Radio/TV Gallery acts as a gatekeeper to ensure an orderly process. To date, there have been few problems entailed in providing television coverage. However, to the extent that political programming becomes more popular, the political stakes in how coverage is allocated are likely to increase, giving rise to issues about which events should be covered and by whom.

The growth in the popularity of live political programming will also affect its development and how it is employed in the political process. In fact, it was precisely because C-SPAN did not enjoy a sizable audience that it was able to develop as a public service without a lot of undo attention. Were C-SPAN's popularity to greatly increase, inducing other networks to provide competing services on a for-profit basis, C-SPAN might be forced to adopt a much more commercial, but politically less useful, format.

### Polling of Voter Preferences

Writing in 1916, the English political theorist, James Bryce, looked forward to the day when:

... the will of the majority (would) be ascertainable at all times, and without the need of its passing through a body of representatives, possibly without the need of voting machinery at all . . . To such a condition of things the phrase, "Rule of public opinion," might be most properly applied, for public opinion would not only reign but govern.<sup>156</sup>

Moreover, with the development of public opinion polling two decades later, a democracy built to this

<sup>151</sup>As cited in Andrew Rosenthal, "C-SPAN's Spotlight Brings Quiet Corners of Campaigning Into View," *The New York Times*, Oct. 22, 1987.

<sup>152</sup>As Thomas P. Southwick points out, members of the press value C-SPAN, which allows them to follow issues in greater depth and to see candidates operating over time and in a variety of different contexts. "C-SPAN Plays a Pivotal Role in 1988 Presidential Elections," *Multichannel News*, Nov. 30, 1987.

<sup>153</sup>Jeannine Aversa, "Study: C-SPAN Viewership Up 43% Since November 1984," *Multichannel News*, Jan. 25, 1988, p. 20.

<sup>154</sup>Lloyd Trufelman, "Audio/Visual Targeting Through Cable Television," Swerdlow (ed.), op. cit., footnote 121, p. 27.

<sup>155</sup>Rob Stoddard, "Taking Politics to the Skies," *Satellite Communications*, April 1988, as reprinted in Swerdlow (ed.), op. cit., footnote 121, p. 178.

<sup>156</sup>James Bryce, *The American Commonwealth* (New York, NY: Macmillan, 1916), vol. II, pp. 261-262.

form appeared reliable. Early public polling techniques, however, proved to be far too inadequate. Thus, it has been only recently, with the advance of communication and information technologies, that proponents of direct democracy have begun to reemerge.<sup>157</sup>

New communication technologies make polling not only easier, but also more accurate. Computers can be used to select random samples of voters or to target particular demographic groups. They can also be used to aggregate, analyze, and widely disseminate results.

Although most direct communication with respondents is still conducted by telephone, the process is now greatly facilitated, given automatic dialing and voice-stimulated response. Broadcast and cable stations also conduct polls—generally by posing a question, together with a range of answers, and inviting interested parties to respond via an 800 number. With new interactive media, such as cable TV and electronic bulletin boards, polling can now be done more directly. For example, with interactive cable, a viewer can respond to questions by pushing a button on the cable box, thereby sending a signal to the station. Conceivably, interactive technologies would allow polling to take place on every public issue, permitting one form of electronic democracy.<sup>158</sup>

These enhanced public polling techniques could be used to provide citizens with greater information and to stimulate their interest in public affairs. They could serve, moreover, to provide government representatives with additional information about their constituents' views. According to Christopher Arterton, who analyzed 13 local experiments in the use of interactive communication technologies, this kind of positive outcome is most likely when technology is not used to bypass government, but rather to improve citizens' access to decisionmakers and broaden participation.<sup>159</sup>

Others are much more skeptical, and in some cases even alarmed, about the future prospects of polling technologies. Many note, for example, that polling could enhance the voice of a self-selected subset of citizens. This is likely to be the case when members of an audience are given the option to respond. Self-selected participants may either be more intensely concerned about a given issue, or not very concerned at all. In either case, their opinions would not be representative of the general public.

New polling techniques could also be used to manipulate the public, a possibility suggested by political scientist, Benjamin Ginsberg. According to Ginsberg, the power to manipulate public opinion has affected its nature as well as its relationship to government. No longer a voluntary activity, but rather an externally subsidized activity, polling has been transformed from a spontaneous assertion to a constrained response, and from a property of groups to an attribute of individuals. As a result, argues Ginsberg:

Polling has rendered public opinion less dangerous, less disruptive, and, perhaps, more amenable to governmental control.<sup>160</sup>

Others discount polling as being politically irresponsible because it tends to discourage deliberation and debate. However, some are more sanguine about the impact of polling, believing that the public will not support it. As Pool and Alexander note:

The notion is that the ancient dream of direct democracy, in which the people themselves vote on the issues instead of merely periodically choosing representatives, can at last be made a reality. It rests upon a total misunderstanding of the legislative process . . . Clearly any instant referendum scheme is so destructive as to be inconceivable.<sup>161</sup>

Others agree. They criticize instant polls because they lack prior debate, provide only a sketchy presentation of positions and facts, and provide no overall context in which choices can be made.<sup>162</sup>

<sup>157</sup>For a discussion, see Christopher Arterton, *Teledemocracy: Can Technology Protect Democracy?* (Beverly Hills, CA: Sage, 1987); Benjamin Barber, "The Second American Revolution," *Channels*, February-March 1982, pp. 25, 62; and Pool and Alexander, op. cit., footnote 126.

<sup>158</sup>Most systems have not yet been designed to allow real interaction between respondents and the pollster, or to allow discussion among respondents. Instead, the audience merely responds to preset choices defined by program producers. In 1977, Warner Amex set up a trial system such as this in Columbus, OH. Called QUBE, this system allowed subscribers to send signals back to the system via a hand-held keypad. It was eventually discontinued because of low demand and high financial costs. For a description of QUBE, see Everett M. Rogers, *Communication Technology* (New York, NY: The Free Press, 1986), pp. 62-64.

<sup>159</sup>Arterton, op. cit., footnote 157.

<sup>160</sup>Ginsberg, op. cit., footnote 142, p. 63.

<sup>161</sup>Pool and Alexander, op. cit., footnote 1\*6, p. 79.

<sup>162</sup>For one discussion, see Barber, Op. cit., footnote 157, pp. 21-25.62.

How polling is eventually employed, and its impact on American democracy, will depend in the long run on whether, becoming cognizant of the potential power of polling, government establishes

democratic norms and rules for its use. Of critical importance will be who does the polling, how extensively it is used, and whether or not it is meant to provide a substitute for other political processes.



**Chapter 7**

# **Communication and the Production of Culture**

## CONTENTS

	<i>Page</i>
INTRODUCTION .....	181
THE CULTURAL REALM .....	181
COMMUNICATION TECHNOLOGIES AND CULTURAL ACTIVITIES .....	182
THE IMPACT OF COMMUNICATION TECHNOLOGIES ON AMERICAN CULTURE .....	183
OPPORTUNITIES FOR USE OF NEW TECHNOLOGIES IN THE CULTURAL REALM .....	188
Community and Culture .....	188
Education and Culture .....	195
Religion and Culture .....	200
Entertainment and Popular Culture .....	203

### *Boxes*

<i>Box</i>	<i>Page</i>
7-A. Forms of Community Cable .....	194
7-B. Steps for Making Cable TV .....	195

# Communication and the Production of Culture

---

## INTRODUCTION

Societies are bound together and adapt to changing circumstances by virtue of the wealth of cultural resources on which they can draw. Communication and information technologies have often played a critical role in developing and enhancing these resources. Throughout American history, technologies such as the telegraph, telephone, radio, and television have facilitated the Nation's expansion westward; its transformation from a rural, agriculture society to an urban, industrialized one; and the integration of a wide variety of diverse ethnic groups into one, unified Nation. Today, many people look to the new communication and information technologies to help solve some of the social and cultural problems associated with a postindustrial era, such as illiteracy, personal isolation, crime, and the breakdown of families and communal groups.

From a technical standpoint, it is clear that many of these new technologies have considerable potential. Given their networking capabilities, they can provide an expanded infrastructure for information sharing and exchange. In addition to generating more information and new kinds of cultural forms, they can also be used to make this knowledge more accessible and to provide it in more convenient and suitable ways. Because they are decentralized and can thus be made more widely available, the technologies may create opportunities for many new people to become actively involved in creative activities. Given their ability to store and retrieve vast quantities of information, they can also serve as a storehouse of cultural resources, making them accessible and available for generations and civilizations to come.

However, just as history testifies to some of the positive benefits that communication technologies can provide in the cultural realm, it also illustrates some past disillusionments and points to some of the unintended cultural problems and consequences often associated with the introduction of new technologies. Above all, it is a reminder that the

impact of new technologies in the realm of culture depends as much, if not more, on social and economic factors as it does on technological ones. With this experience in mind, this chapter will seek to identify and analyze the cultural opportunities that new communication technologies engender, and the factors or obstacles that might limit or preclude their optimal use.

## THE CULTURAL REALM

Culture can be defined as a system of symbols, beliefs, behaviors, and institutions that define and reflect the social reality of members of a community. It refers to the realm of "sensibility of emotion, moral temper, and of the intelligence [that] seeks to order these feelings."<sup>1</sup> It comprises all of those imaginative and spiritual activities (such as painting, poetry, or music, as well as litany, liturgy, and ritual) whereby men and women seek to understand their natures—who they are, as well as their relationship to others and to the universe.<sup>2</sup>

Providing a consistent moral and aesthetic frame of reference, culture serves to develop and sustain the identities of both individuals and societies. Without a cultural tradition, individuals' interactions would be meaningless. In order to define themselves and to take purposeful action in different situations and in relationship to others, individuals need reference to a relatively stable construct of shared symbols.<sup>3</sup> As such, culture can be thought of as the "glue," the shared values and practices, that holds a society together.

To be effective in this role, however, a culture must sustain a delicate balance between constancy and change, and between diversity and integration. An overemphasis on homogeneity, for example, can lead to repression or stagnation; a lack of integration can bring divisiveness and disarray. On the other hand, protecting diversity while encouraging integration allows a society to adapt to change and to maximize the advantages of its cultural richness. Reflecting this delicate balance we find, therefore, that new art forms and new ideas do not replace old

---

<sup>1</sup>Daniel Bell, *The Cultural Contradictions of Capitalism* (New York, NY: Basic Books, 1976), p. 12.

<sup>2</sup>Ibid.

<sup>3</sup>Talcott Parsons, *The Social System* (Glencoe, IL: Free press, 1964), pp. 11-12.

ones; they become a part of an ever-expanding source on which individuals can draw to recreate and reinterpret experience. Thus, although the ways that people have dealt with their concerns about life may have changed considerably over time and in different eras, the themes that have preoccupied mankind—death, tragedy, love, sacrifice, heroism, obligation, and redemption—have remained constant.<sup>4</sup>

Looking at diversity and integration, we see that cultures are really nested subcultures—groups that, while sharing a common set of beliefs at one level, also display distinctive characteristics. Thus, diversity and integration occur on a number of levels and dimensions, and subcultures can be defined by many factors, including geographic location, urban/rural lifestyle, gender, ethnicity, sexual preference, age, political affiliation, social interest, class, religion, and race.

In an open and democratic society, the balance between integration and diversity and the relationship among subcultures are determined by the degree to which there is access to a wide variety of cultural forms, as well as by the extent to which the opportunities to participate in the production of culture are widely available.<sup>5</sup> It should be noted, moreover, that people can be passive or active in their participation.<sup>6</sup> They can partake of and produce their cultures through institutions like the family, work, education, community, religion, and entertainment. These institutions coordinate individuals' actions, provide role models, inculcate values, and

proscribe behaviors. As people's experiences are structured by the institutions in which they live, their behavior and actions reinforce and reenact their cultures.

## COMMUNICATION TECHNOLOGIES AND CULTURAL ACTIVITIES

Communication is the process by which culture is developed and maintained. Only when people develop language, and thus a way of communicating, can a culture emerge and be imparted.<sup>7</sup> Information, the content of communication, is the basic source of all human intercourse.<sup>8</sup> Over the course of human history, it has been embodied and communicated in an ever-expanding variety of media, including spoken words, graphics, artifacts, music, dance, written text, film, recordings, and computer hardware and software. Together, these media and the channels through which they are distributed form the web of society that determines the direction and pace of social development.

From this perspective, the communication of information permeates the cultural environment and is essential to all aspects of social life.<sup>9</sup> It is the means by which knowledge is created and shared, roles are negotiated, and social relationships are legitimized. Through communication, culture is both maintained and changed; behaviors, and the values that underlie them, are accepted, questioned, or reinterpreted according to circumstances.<sup>10</sup>

Because communication is linked to all social activity, it is clear why the emergence of new communication technologies has, throughout his-

<sup>4</sup>Bell, *op. cit.*, footnote 1, p. 15.

<sup>5</sup>For other discussions about how groups create, maintain, and alter their norms, social practices, and institutions, see Michele Barrett et al. (eds.), *Ideology and Cultural Production* (New York, NY: St. Martin's Press, 1979); Alvin Gouldner, *The Dialectic of Ideology and Technology* (New York, NY: Seabury, 1976); and John Dewey, *Human Nature and Conduct* (New York, NY: Holt, Rinehart and Winston, 1922).

<sup>6</sup>See A.M. Thunberg, K. Norvak, K. Rosengren, and B. Sigurd, *Communication and Equality: A Swedish Perspective* (Stockholm: Almqvist & Wiksell International, 1982).

<sup>7</sup>*Ibid.* For a discussion of the role of language in cultural formation, see also James R. Beniger, *The Control Revolution: Technology and the Economic Origins of the Information Society* (Cambridge, MA: Harvard University Press, 1986), pp. 84-91.

<sup>8</sup>Lucian Pye (ed.), *Communications and Political Development, Studies in Political Development* (Princeton, NJ: Princeton University press, 1965), p. 4.

<sup>9</sup>*Ibid.*

<sup>10</sup>When people communicate, meaning is both assumed and negotiated—some things are taken for granted, and others are interpreted in new ways or brought up for explicit discussion. When people communicate, they are both differentiating and integrating—displaying their distinctiveness as well as demonstrating their commonality.

tory, had a considerable impact on societies.<sup>11</sup> In her analysis of the impact of the printing press on European culture,<sup>12</sup> Elizabeth Eisenstein describes how printing-by greatly increasing the speed and reducing the costs of reproduction—facilitated the dissemination of ideas. By increasing the general level of literacy, it also made more people susceptible to, and eager to partake of, such ideas. As a result, the market for information products and literary works grew, and their economic value was greatly enhanced. Later, as books and manuscripts ceased to be isolated on monastery shelves and became available to many people simultaneously, they began to serve as an important forum for public discussion. Printing and the widespread distribution of books also fostered new relationships among scientists, artists, intellectuals, and their geographically distant counterparts. As Eisenstein has pointed out:

The fact that identical images, maps, and diagrams could be viewed simultaneously by scattered readers constituted a kind of communications revolution itself.<sup>13</sup>

Looking in particular at the effect of communication technologies on the balance between diversity and integration, and among dominant cultures and subcultures, we see that communication technologies exhibit two basic, and contradictory, tendencies.<sup>14</sup> On the one hand, mass communication technologies (notably radio, television, and film) have served to foster unity by providing disparate groups with a common experience. On the other hand, some means of communication allow individuals isolated in thousands of different and distant

towns who have kindred interests to associate with one another and coordinate their activities, encouraging the development of specialized communities. When the various media allow these dual tendencies to exist in equilibrium, there is sufficient social cohesion to sustain a national community, as well as enough variety to protect the pluralistic quality of modern societies.

## THE IMPACT OF COMMUNICATION TECHNOLOGIES ON AMERICAN CULTURE

The dual tendencies toward diversity and integration are in evidence throughout American history as new communication technologies were developed and evolved. The trade routes that bound the American Colonies to England constituted a communication network, and, naturally, many of the messages dealt with commerce. Although transports of the 1600s and 1700s were primitive by today's standards, the British merchant fleets forged a fairly cohesive community that bridged the "English Atlantic."<sup>15</sup> Thus, at least initially, communication tended to strengthen transatlantic feelings of community within the British Empire.

By the mid-1700s, however, communication among the American colonies was growing more intensively than communication with England. Newspapers, which featured nonlocal news, increasingly focused on matters of common interest to colonists. Thus it has been argued that improved

<sup>11</sup>In his book, *The B@ of Communication*, Harold Innis made the case that the communication regime is the key variable determining the nature of any culture and society. At one extreme, according to Innis, are bulky, durable media that foster civilizations of limited extent and permit tight control by a hierarchy of religious and political leaders, often one and the same. These media emphasize the preservation of information over time and are associated with cultures that treasure religion, stability, tradition, and history. At the other extreme are light, ephemeral media. They foster expansive civilizations in which control over provinces is centralized in a distant capital. These media emphasize the dissemination of information over wide areas and are associated with cultures that prize secular matters, trade, and scientific inquiry. Communication technologies, in Innis's shorthand, have either a time or a space bias. See Harold Innis, *The Bias of Communication* (Toronto: University of Toronto Press, 1951).

<sup>12</sup>Elizabeth L. Eisenstein, *The Printing Press as an Agent of Change Communications and Cultural Transformations in Early Modern Europe*, vols. I and II (Cambridge, England: Cambridge University Press, 1982).

<sup>13</sup>*Ibid.*, p. 56.

<sup>14</sup>John Carey, "The Communication Revolution and the Professional Communicator," *Sociological Review Monograph*, vol. 13, January 1969, pp. 23-38.

<sup>15</sup>Despite the vast distances separating members, specialized associational communities of different religious groups, political interests, and merchants enjoyed regular, albeit slow, transatlantic correspondence. Quakers, for example, exploited the available means of communication to maintain their sense of community with the faithful in other North American colonies as well as in England, Ian K. Steele, *The English Atlantic 1675-1740: An Exploration of Communication and Community* (New York, NY: Oxford University Press, 1986), pp. 263-265.

intercolonial communication—a function of better roads and more coastwise shipping—heightened inhabitants’ sense of American community.<sup>16</sup>

Revolutionary propagandists did more than just wait for changing patterns of communication to foster a new consciousness; they actively took part in restructuring the communication system to accelerate the emergence of a truly American community. Three years before the Declaration of Independence, revolutionaries wrested control of the American posts from the British. By transmitting news from New Hampshire to Virginia, the “Constitutional Post” was designed to fuse colonists, whose interests and experiences varied widely, into a unified whole.<sup>17</sup>

Throughout most of the 19th century, the United States was a society of “island communities”—cities and towns with limited interaction.<sup>18</sup> The postal system provided one bridge, probably the most important, that connected a widely dispersed population. People wanted access to national news and market information, but they increasingly realized that potential economic and cultural influence followed communication routes. A cultural debate erupted concerning how to foster national integration through communication without undermining the viability of local communities.

With improvements in printing technology and the postal delivery system, a new kind of community was built, bound not by space but by specialized interests. Thus, for example, as American society developed different political groups, partisan papers became:

... a major force for factional or party cohesion, communicating partisan information and views from the centers of power to the outlying communities.<sup>19</sup>

Similarly, the various social movements of the 19th century developed communication mechanisms to engender a sense of community among adherents.

The telegraph, on the other hand, made social existence more uniform. Because of high costs, telegraph use was confined largely to businesses and the press; few people used it for social communication, at least in the United States.<sup>20</sup> However, by fostering the standardization and the central processing of news reports, the telegraph meant that, for the first time, Americans were able to read essentially the same national and international news stories, a development presaging true mass communication.<sup>21</sup>

On another level, the telegraph brought a uniformity and large-scale coordination to people’s everyday existence. Before the railroad and telegraph, society’s “island communities” geared their time to local rhythms. For example, Michigan had 27 time zones, Indiana 23, and Wisconsin 39.<sup>22</sup> The advent of the railroad required the coordination of schedules over large areas, and conducting business via telegraph required knowledge of precise times around the world. Hence, standard time zones were established in 1883. As Carey notes:

The telegraph facilitated the temporal coordination and integration of the entire system for business, government, and social life.<sup>23</sup>

The telephone also had a major impact on American culture. It was the only innovation since the mails to effectively increase opportunities for individuals, as opposed to institutions, to send and

<sup>16</sup>See Richard L. Merritt, *Symbols of American Community 1735-1775* (New Haven, CT: Yale University Press, 1966). Analyzing newspaper content between 1735 and 1775, he found growing coverage of colonial affairs. More important, perhaps, colonial newspapers used more words and symbols associated with America and fewer associated with England and empire.

<sup>17</sup>Ward L. Miner, *Goddard: Newspaperman* (Durham, NC: Duke University Press, 1962). PP. 111-136.

<sup>18</sup>Robert Wick, *The Search for Order, 1877-1920* (New York, NY: Hill and Wang, 1967), p. xiii.

<sup>19</sup>William Chambers, *Political Parties in a New Nation* (New York, NY: Oxford University Press, 1963), P. 42.

<sup>20</sup>In European countries, where the telegraph was a government monopoly supervised by the postal authorities, people made greater use of the wires for personal correspondence.

<sup>21</sup>Before the telegraph, editors obtained nonlocal news through the mails essentially cost-free. They culled their exchanges and selected accounts deemed suitable for local readers. News-gathering by wire, in contrast, entailed more costs; press associations, such as the New York Associated Press, were organized to spread the expense of news-gathering and transmitting among many users. News was converted into a commodity to be sold, discounted, and marketed just like any other product. See Frederick Hudson, *Journalism in the United States* (New York, NY: Harpers, 1873), for a history of early news associations. For other discussions of the impact of the telegraph on news-gathering, see F.B. Marbut, *News From the Capital* (Carbondale, IL: Southern Illinois University Press, 1971); and Robert Thompson, *Wiring a Continent: The History of the Telegraph Industry in the United States 1832-1866* (Princeton, NJ: Princeton University Press, 1947).

<sup>22</sup>James Carey, “Technology and Ideology: The Case of the Telegraph,” *Prospects*, vol. 8, 1983, pp. 303-325.

<sup>23</sup>*Ibid.*, p. 323.

receive messages. This radical potential, however, was only slowly realized. The telephone, much like the telegraph before it, was initially used only by business. Ultimately, the telephone vastly increased personal communication within towns and metropolitan areas and, by all accounts, it was especially instrumental in enhancing rural life. This success in fostering local communities was partly the result of Federal policy mandating universal access.<sup>24</sup>

The trend toward the national distribution of printed matter culminated with the emergence of inexpensive popular magazines. Entrepreneurs launched national magazines in the 1880s and 1890s expressly to serve as vehicles for advertising brand-name consumer items featured by mass retailers.<sup>25</sup> This new genre of magazines, epitomized by Curtis Publishing Co.'s *Saturday Evening Post*, *Ladies' Home Journal*, and *Country Gentleman*, cut subscription rates to attract a mass middle-class audience.<sup>26</sup> With advertising-filled periodicals blanketing the Nation, the heavily subsidized second-class mailings grew 20 times faster than the population in the four decades after 1880.<sup>27</sup>

Motion pictures also did much to shape a national community of tastes, style, and culture. Although films are not tied directly to the marketing system,

they have nonetheless served as a powerful tool to promote consumer goods and services. Indeed, they became one of the first communication instruments to project American culture throughout the world.<sup>28</sup> Some governments reacted to the flood of U.S. films with quotas as early as 1927, justifying them on the grounds of protecting their national cultures from the incursions of the values and products purveyed by Hollywood. At the other extreme, some foreign observers welcomed the Americanization of film as the first step in the development of a true world community.

Films quickly established themselves as a principal form of entertainment. Weekly attendance in the United States rose from an estimated 40 million in 1922 to 115 million 8 years later.<sup>29</sup> With this explosive growth, which cut across geographic and socioeconomic lines, came concerns about the effects of the new medium.<sup>30</sup> While the censors watched for scenes that seemingly encouraged crime or sexual promiscuity, they missed a more subtle yet pervasive effect: film's power to nationalize tastes for cultural fare as well as consumer goods.<sup>31</sup>

Radio augmented the effects of magazines and motion pictures as agents of national culture. Although radio was originally envisioned as a local

<sup>24</sup>**Telephony, more than earlier technologies, increased** opportunities for social communication at the 10CSJ level and had dramatic consequences for residents of rural areas. While AT&T promoted the development of the long-distance network, towns and cities launched their own systems, especially after Bell's major patents expired in 1894. See Malcolm Willey and Stuart A. Rice, *Communication Agencies and Social Life* (New York, NY: McGraw-Hill, 1935). See also Michael Olsen, "But It Won't Milk the Cows: Farmers in Colfax County Debate the Merits of the Telephone," *New Mexico Historical Review*, vol. 61, January 1986, pp. 1-13; and Ithiel de Sola Pool, *Forecasting the Telephone: A Retrospective Technology Assessment* (Norwood, NJ: Ablex Publishing Co., 1983), pp. 48-54.

<sup>25</sup>Theodore Peterson, *Magazines in the Twentieth Century* (Urbana, IL: University of Illinois Press, 1964), pp. 1-43.

<sup>26</sup>The mails, of course, were crucial in delivering these publications, and the inauguration of Rural Free Delivery (RFD) in the 1890s enabled magazines to flow from publishers to country lanes. See Wayne E. Fuller, *RFD: The Changing Face of Rural America* (Bloomington, IN: Indiana University Press, 1964).

<sup>27</sup>The explosive growth of popular magazines intensified competition for advertising among segments of the publishing industry and corresponded to shifts in the Nation's marketing system. The small, local retailers that had once served their communities with little competition faced a succession of challengers—department stores, mail-order firms, and chain stores. See Alfred D. Chandler, *The Visible Hand: The Managerial Revolution in American Business* (Cambridge, MA: Harvard University Press, 1977), pp. 224-235.

<sup>28</sup>See Thomas H. Guback, "Theatrical Film," Benjamin Compaine (ed.), *Who Owns the Media? Concentration of Ownership in the Mass Communications Industry* (White Plains, NY: Knowledge Industry Publications, Inc., 1979), p. 181. According to Guback, World War I disrupted the European film industry and paved the way for American dominance of this medium. As he says: "It was possible for American films to achieve this dominance because, in part, investments in them were recouped in the home market, which had about half the world's theatres, and thus films could be rented abroad at rates often undercutting those of foreign competitors."

<sup>29</sup>Willey and Rice, *op. cit.*, footnote 24, p. 179.

<sup>30</sup>Daniel Czitrom, *Media and the American Mind* (Chapel Hill, NC: University of North Carolina Press, 1982), pp. 30-59. See also Robert E. Davis, "Response to Innovation: A Study of Popular Argument About New Mass Media," Ph.D. dissertation, University of Iowa, 1965.

<sup>31</sup>Observers in the United States and abroad noticed that trends in manners, furnishings, toiletries, clothing, and even hairstyles followed the cinema. Styles and fads that had diffused slowly and unevenly in the age of print now pervaded the Nation in a matter of weeks, if not days. Marketers of nationally distributed consumer goods naturally capitalized on the possibilities presented by film. Willey and Rice, *op. cit.*, footnote 24, pp. 181-184. The ability of film to foster a national community of tastes and consumption was abetted by the tight economic controls that lasted through the medium formative years. A relative handful of companies controlled film production, distribution, and exhibition—especially distribution. Producers forced independent exhibitors to accept certain films (the studios also owned many of their own theaters) through a practice known as block booking. To get highly popular films, theaters had to accept several others. Garth Jowett, *Film: The Democratic Art* (Boston, MA: Little Brown and Co., 1976), p. 202.

medium, a number of factors promoted the development of national networks. Among these factors were:

- agreements made among key industry players to divide up the responsibility and opportunity to develop and exploit the new technology;<sup>32</sup>
- the audience demand for more expensive productions, which only networks could afford;<sup>33</sup>
- the development of a system of financing based on national advertising, which called for national programming;<sup>34</sup> and
- regulatory decisions made in radio's formative years that inadvertently prompted the formation of national networks.<sup>35</sup>

Data on station affiliation, programming, and advertising revenue confirm the national orientation of radio. As Daniel Czitrom has noted:

In 1937 NBC and CBS owned or controlled 210 of the 685 total stations, but these accounted for more than 88 percent of the total wattage power of American broadcasting.<sup>36</sup>

Ten years later, 97 percent of all radio stations were affiliated with a network.<sup>37</sup> Through the 1930s and 1940s, radio was the preeminent medium of mass impression, eclipsing newspapers, magazines, and even film.<sup>38</sup>

In its centralizing/decentralizing tendencies and accompanying policies, television's history reprised that of radio. As with radio, technical problems encountered in interconnecting stations initially spawned a great deal of local and regional programming. While AT&T was laying coaxial cables for television networking, Chicago and other cities developed distinctive, innovative programs that were picked up for national distribution. As Baughman notes:

Critics spoke of a "Chicago touch"--a creative, detached, and continually bemused style quite apart from that of New York or southern California.<sup>39</sup>

Like radio, television was also conceived in a regulatory environment that emphasized localism. According to Nell, Pick, and McGowan, the FCC's:

... vision of broadcasting . . . foresaw a local television station in as many communities as possible . . . Larger communities would have several *stations*, but only to the extent that channels were available for small communities as well. Stations would be owned and managed by local residents, and would devote considerable broadcast time to information and commentary on important local issues. The stations would be instruments for community enlightenment and cohesion, much like the hometown newspaper of an earlier era.<sup>40</sup>

<sup>32</sup>Susan Smulyan, "The Rise and Fall of the Happiness Boys: Sponsorship, Technology and Early Radio Programming," paper presented at the 1985 annual meeting of the Society for Historians of Technology.

<sup>33</sup>Listeners demonstrated a fascination with tuning in distant stations. At first, this reflected interest in the technical novelty of radio, but later it stemmed more from the ability of high-power stations or networks to offer well-known talent in alluring productions. Ibid.

<sup>34</sup>Once radio discovered advertising as its economic base, sponsors exerted a great deal of influence on programming. Indeed, sponsors created the most popular programs and controlled the talent. Ibid.

<sup>35</sup>Localism, as conceived by regulators, actually impelled the growth of national networks. When most cities were assigned two, three, or four stations, licensees began looking for a source of programming. Most stations realized that affiliation with one of the three or four networks was the profitable choice. Control over radio content, therefore, was ceded to New York. The networks capitalized on their relationships with affiliates and forced onerous contractual obligations on licensees that further circumscribed their choice. Thus, radio did not begin to fully realize its potential as a medium affording local self-expression until the advent of television altered the media environment. See Bruce Owen, *Economics and Freedom of Expression: Media Structure and the First Amendment* (Cambridge, MA: Ballinger Press, 1975). See also Christopher Sterling, "Television and Radio Broadcasting," *Compaine* (cd.), op. cit., footnote 28.

<sup>36</sup>Czitrom, op. cit., footnote 30 > p. 80.

<sup>37</sup> Sterling, op. cit., footnote 35, p. 66. Affiliate and even network owned-and-operated stations, could, of course, originate local programming. But in 1938, the FCC reported that national networks furnished 29.2 percent of all programs; regional networks 3.8 percent; local stations 30.8 percent; electrical transcriptions 20.8 percent; records 11.67 percent; and announcements 3.8 percent. Nearly two-thirds of all radio programs, therefore, came from national or regional suppliers, and probably a disproportionate share of this aired during prime-time evening hours. C.B. Rose, *National Policy for Radio Broadcasting* (New York, NY: Harper and Brothers, 1940), p. 145.

<sup>38</sup>A well-known sociologist of the time enumerated 150 effects of radio, some trivial, others profound. Several dealt with radio's capacity to promote uniformity and diffusion of culture--the "homogeneity of people increased because of like stimuli"; "regional differences in cultures become less pronounced"; "penetration of the musical and artistic city cultures into villages and country"; "standards of the city made more familiar to the country"; "isolated regions are brought into contact with world events." See W.F. Ogburn, "The Influence of Invention and Discovery," Recent *Social Trends in the United States: Report of the President's Research Committee* (New York, NY: McGraw-Hill, 1933), pp. 122-166.

<sup>39</sup>James L. Baughman, "Television in the 'Golden Age': An Entrepreneurial Experiment," *Historian*, vol. 47, February 1985, pp. 175-179.

<sup>40</sup>Roger Noll, Merton J. Peck, and John J. McGowan, *Economic Aspects of Television Regulation* (Washington, DC: The Brookings Institution, 1973), p. 100.



As with radio, attaining localism in television was partly frustrated by the economics of programming. With two or three local stations serving most communities in television's formative years, only three networks attracted enough affiliates to thrive. By 1969, the networks supplied 82 percent of their affiliates' prime-time programming, and a good share of the remaining time was filled with "nonnetwork films and other national programming."<sup>41</sup>

Television's failure to realize its potential as a local medium was also reflected in its advertising. From the mid-1950s to mid-1970s, local advertising furnished only between 15 percent and 25 percent of television's revenues. The rest came from network advertising as well as national and regional spot advertising. Moreover, television's national advertising had some anticompetitive effects through discounts to heavy users and the cost barriers erected by high rates, both of which favored large established firms.<sup>42</sup>

Network television, then, has become the national forum without equal, the principal communication mechanism for maintaining a sense of national community. Television coverage of certain events—such as the Super Bowl and major congressional hearings—focuses people's attention on the same subject regardless of location or class.

Television significantly preempted the role of newspapers, magazines, motion pictures, and radio as purveyors of information and entertainment to mass audiences. As a result, the established media found narrower niches in the communication environment. The trend toward fragmenting the mass audience was abetted, at least modestly, by the advent of cable television.

Responding to television, and radio before it, newspapers emphasized their traditional strength—

local and regional service. National and international news continued to be produced centrally in a few locations, but in terms of marketing strategies newspapers increasingly identified their immediate community as the principal service area.

In its appeal to a large, heterogeneous audience, television displaced many of the large-circulation popular magazines.<sup>43</sup> *Life* (at least in its original incarnation) and *Look* succumbed when television became a more cost-effective vehicle to deliver the mass audience to advertisers. Like newspapers, the magazine industry has continued to thrive by developing one of its long-standing dimensions—specialized publications. But unlike newspapers, which are defined by geography, magazines reflect continuing differentiation in the realms of work, cultural interests, religious and ethnic backgrounds, and the like. Specialized magazines sustain these interest communities by providing information and symbolic reinforcement missing in the more general media.<sup>44</sup>

Television's effects on the existing media environment were nowhere more pronounced than in the radio industry. Radio's role as a national force declined, but in the process it became more like the regulators originally envisioned—a vehicle for local self-expression. Advertising provides an accurate barometer of this shift. In radio's heyday before World War II, it derived roughly one-fourth of its revenue from local advertising; now about three-fourths of its advertising dollars comes from local sources.<sup>45</sup> For its programming, radio divided the mass audience along the lines of age, interest in news, musical tastes, and activities. The specializa-

<sup>41</sup>*Ibid.*, p. 109. The perceived dominance of the networks triggered recurrent FCC inquiries and led to the adoption of two remedies. First, the FCC considered proposals to deintermix ultra high frequency (UHF) and very high frequency (VHF) stations in the same market. Although the most ambitious deintermixture proposals encountered roadblocks, Congress did empower FCC to require the production of sets that could receive both VHF and UHF. For a discussion, see Erwin G. Krasnow, Lawrence D. Langley, and Herbert A. Terry, *The Politics of Broadcast Regulations*, 3d ed. (New York, NY: St. Martin's Press, 1982), pp. 176-191. Another policy initiative, the Prime-Time Access Rule, was aimed more directly at the excessive standardization and national orientation of television fare. The FCC launched this policy in 1970. It required affiliates in the 50 largest markets to broadcast at least 1 hour of nonnetwork programming, with some exceptions, during prime-time. The effect of the rule has been hotly debated.

<sup>42</sup>Noll et al., *op. cit.*, footnote 40! pp. 37-39.

<sup>43</sup>Peterson, *op. cit.*, footnote 25.

<sup>44</sup>See Benjamin Compaine, "Magazines," in Compaine (ed.), *op. cit.*, footnote 28. See also James L.C. Ford, *Magazines for Millions: The Story of Specialized Publications* (Carbondale, IL: Southern Illinois University Press, 1969). In this sense, the magazine's function has changed little since abolitionists, feminists, and other 19th-century activists launched some of the first specialized magazines. Marketers also find special-interest publications a cost-effective way to reach specific consumers.

<sup>45</sup>Christopher H. Sterling and John M. Mitross, *Stay Tuned: A Concise History of American Broadcasting* (Belmont, CA: Wadsworth Publishing Co., 1978), pp. 516-517.

tion forced on radio by television opened the doors to more educational and public broadcasting, and to a closer realization of FM's potential.<sup>46</sup>

Motion pictures took the longest to rebound from the effects of television. Although still a mass medium, film also underwent some specialization of function.<sup>47</sup> Film developed technologies to distinguish itself from the small screen. More important, it provided more variety, for example, by importing and emulating foreign motion pictures. Some films were aimed largely at children, others at teenagers, still others at adults.

Originating as a means to extend the reach of television, cable television has grown to supplement broadcast fare. Its success in providing complementary programming, however, has thus far been limited. Without a doubt, cable increased the viewer's choice. Much of the choice, however, consisted of Hollywood-made films or former network series in syndication. To some extent, then, cable has just augmented the supply of nationally available programming aimed at a general audience. In other words, it has operated as another medium conveying material produced far beyond the viewer's community.

## OPPORTUNITIES FOR USE OF NEW TECHNOLOGIES IN THE CULTURAL REALM

Communication technologies have had a significant effect on the cultural realm in the past, and new technologies are likely to have a major impact in the future. Communication technologies can serve to fragment groups as well as bind them together. Moreover, experience illustrates that although some technologies appear to foster unity, and others differentiation, the actual impact they will have in the cultural realm will depend as much on the social, economic, and political circumstances in which they emerge as on the particular attributes of the technologies themselves. Thus, government can take some steps to affect the outcome if it has an approximate picture of the alternatives available.

To provide such a picture, this section will examine applications of new communication technologies in four major cultural settings and institutions: community, education, religion, and popular culture and entertainment. The focus of analysis in the cultural realm is on institutions because systems of symbols, objects, and actions alike are generally developed, produced, and maintained through institutional frameworks.<sup>48</sup> Although any number of social institutions might have been chosen for analysis, these four were selected because of their primacy in terms of issues of national culture and public policy, and because of the significant changes that communication technologies are making possible in these areas.

### *Community and Culture*

A community can be defined as a group of people who are recognized by outsiders and by members as having a commonality of purpose, who share common patterns of attention and interest, and who coordinate their activities through patterns or structures of interaction.<sup>49</sup> This definition includes traditional communities based on geographic, historical, and ethnic ties, but also includes "communities of interest" that grow up around shared activities and concerns. It also allows us to look at communities not just as places, but also as social products and processes.<sup>50</sup>

Communities have been the traditional building-blocks of American culture. As historian Daniel Boorstin has pointed out:

Americans reached out to one another. A new civilization found new ways of holding men together—less and less by creed or belief, by tradition or place, more and more by common effort and common experience, by the apparatus of daily life, by their ways of thinking about themselves. Americans were now held together less by their hopes than by their wants, by what they made and what they bought, and by how they learned about everything. They were held together by the new names they gave to the things they wanted, to the things they owned, and to themselves. These everywhere communities

<sup>46</sup>Ibid., pp. 248-314.

<sup>47</sup>Jowett, *op. cit.*, footnote 31, pp. 347-359.

<sup>48</sup>Karl Erik Rosengren, "Linking Culture and Other Social Systems," Sandra J. Ball-Rokeach and Muriel G. Cantor (eds.), *Media, Audience, and Social Structure* (Beverly Hills, CA: Sage Publications, 1989), pp. 88-90.

<sup>49</sup>This definition condenses a number of definitions found in Merritt, *op. cit.*, footnote 16, pp. 15-16.

<sup>50</sup>See James W. Carey, *Communication as Culture: Essays on Media and Society* (Boston, MA: Unwin Hyman, 1989), especially ch. 1, "A Cultural Approach to Communications."

floated over time and space, they could include anyone without his effort, and sometimes without his knowing . . . Americans lived not merely in a half-explored continent of mountains and rivers and mines, but in a new continent of categories. These were the communities where they were told (and where they believed) that they belonged.<sup>51</sup>

However, as the United States evolved from an agricultural to an industrial society, and more recently to a postindustrial one, American communities have undergone considerable change. In their classic works, *Middletown: A Study of Contemporary American Culture*<sup>52</sup> and *Middletown in Transition: A Study in Cultural Conflicts*,<sup>53</sup> Robert and Helen Lynd traced, for example, how the town of Muncie, IN, changed in response to industrialization. They found that industrialization had led to a division between the business and working classes, and a breaking down of the quasi-religious ethos of the individual citizen, which previously had knitted many diverse groups and interests together. With the rise of the business class, a new ethic of utilitarian individualism began to emerge.<sup>54</sup>

More recent works on American culture trace the continuation of this trend. As described by Bellah et al.:

Perhaps the crucial change in American life has been that we have moved from the local life of the nineteenth century—in which economic and social relationships were visible and, however imperfectly, morally interpreted as parts of a larger common life—to a society vastly more interrelated and integrated economically, technically, and functionally. Yet this is a society in which the individual can only rarely and with difficulty understand himself and his activities as interrelated in morally meaning-

ful ways with those other, different Americans. Instead of directing cultural and individual energies toward relating the self to its larger context, the culture of manager and therapist urges a strenuous effort to make of our particular segment of life a small world of its own.<sup>55</sup>

A number of demographic trends are likely to reinforce these developments, critically affecting the nature of American communities in the future. Among these trends are:

- an increase in the percentage of the population accounted for by immigrants, and especially by those immigrant groups that previously were not strongly represented within the population;<sup>56</sup>
- changing family and lifestyle patterns, and a growing diversity among households. Today, for example, there are fewer American couples living with children than ever before, more people live alone or with unrelated adults, and more children will live at least part of their childhood with a single parent;<sup>57</sup> and
- a changing work force, with an increase in the proportion of women, especially among those in their prime child-bearing years; as well as an increase in the age of the work force population, which will lead, in turn, to blurring of the boundaries between the workplace and the home.<sup>58</sup>

Together, these structural changes within society are likely to have a radical impact on community life. Although there is some disagreement with respect to the nature and extent of these changes, most observers agree that they will lead individuals

<sup>51</sup>Daniel Boorstin, *The Americans: The Democratic Experience* (New York, NY: Vintage Books, 1974), p. 2.

<sup>52</sup>Robert and Helen Lynd, *Middletown: A Study of Contemporary Culture* (New York, NY: Harcourt Brace, 1929).

<sup>53</sup>Robert and Helen Lynd, *Middletown in Transition: A Study of Cultural Conflicts* (New York, NY: Harcourt Brace, 1937).

<sup>54</sup>These findings were reinforced by the work of the sociologist, David Riesman. See, for example, David Riesman with Nathan Glazer and Reuel Denney, *The Lonely Crowd: A Study of the Changing American Character* (New Haven, CT: Yale University Press, 1950). See also the study by Herve Varenne of a small town in southern Wisconsin, entitled *Americans Together: Structured Diversity in a Midwestern Town* (New York, NY: Teachers College Press, 1977).

<sup>55</sup>Robert N. Bellah, Richard Madsen, William M. Sullivan, Ann Swidler, and Steven M. Tipton, *Habits of the Heart* (New York, NY: Harper and Row, 1985), p. 50. See also Richard M. Merelman, *Making Something of Ourselves: On Culture and Politics in the United States* (Berkeley and Los Angeles, CA: University of California Press, 1984).

<sup>56</sup>Joseph F. Coates and Jennifer Jarratt, "Forces and Factors Shaping Education," prepared for the National Education Association (Washington, DC: J.F. Coates, Inc., 1989), pp. 4-5. As the authors note: "Many of the new immigrants will have unfamiliar attitudes toward government, education, work, social behavior, and other social values. As political power accumulates to these new Americans, there will be effective challenges to schools, public officials, employers, media, laws, rules, and customs."

<sup>57</sup>*Ibid.*

<sup>58</sup>*Ibid.*

to find new **ways** of establishing community ties and of fulfilling some of the positive functions performed by traditional communities.<sup>59</sup>

What will provide a sense of continuity, belonging, and responsibility in the “information age?” One author conjectures:

... although the yearning for the small town is nostalgia for the irretrievably lost, it is worth considering whether the biblical and republican traditions that small towns once embodied can be reappropriated in ways that respond to our present need. Indeed, we would argue that if we are ever to enter that new world that so far has been powerless to be born, it will be through reversing modernity’s tendency to obliterate all previous culture. We need to learn again from the cultural riches of the human species and to reappropriated and revitalize those riches so that they can speak to our condition today.<sup>60</sup>

Capable of strengthening and reinforcing human interactions, and of extending the reach of people beyond their immediate geographies, communication technologies have played a critical role in maintaining community in the context of a rapidly changing and highly mobile society. New communication technologies offer some potential to ameliorate, or at least help people cope with, the loss of many traditional communal ties. Two kinds of communication applications will be considered here: the possibilities for establishing “virtual communities,” and for extending community-access programming and distribution facilities.

### **Virtual Communities Supported by Electronic Networks**

Virtual communities, supported by electronic networks, create the opportunity for providing new sources of contact and interaction among people, widening their circle of friends and making it easier to connect with others like themselves. Like the “communities of interest” supported by the postal system and the telephone, virtual communities comprise groups of geographically dispersed peo-

ple, united by a common interest or purpose and supported by computer communication such as bulletin boards, conferences, and electronic mail.<sup>61</sup>

In the United States, virtual communities have grown up among people with access to computers and modems. The largest conferencing systems are on commercial services such as The Source. However, any individual with a personal computer and conferencing software could establish a gathering place for others who have personal computers, modems, and communication software.

The Whole Earth ‘Lectronic Link (WELL), for example, supports a virtual community in the San Francisco Bay area. With a local telephone call from many local communities, subscribers can participate in hundreds of topically based conferences. Although people from all over the country can and do participate by paying long-distance charges or using one of the national data networks, most of the conversation has a “northern California” perspective. References to local establishments and events abound, and participants meet periodically for parties and picnics.

The Community Memory Project, also in San Francisco, has put coin-operated terminals in local supermarkets and bookstores, allowing users to post and read messages organized in a relational database.<sup>62</sup> The explicit goal of this project is to revitalize the traditional notion of community as a locus of sharing, support, and responsibility, and to provide a new means for participating in the production of community-based culture.<sup>63</sup>

As in the past, communities with specialized needs are also linking via electronic networks. Recently, for example, a number of antipoverty organizations joined online in a network called HandsNet.<sup>64</sup> By paying an initial fee of between \$95 and \$125, a monthly fee of \$25, and an \$8-per-hour online fee, antipoverty organizations trade statistics and program information. Among the groups in-

<sup>59</sup>Orring Klapp, *Collective Search for Identity* (New York, NY: Holt, Rinehart, and Winston, 1968), p.17.

<sup>60</sup>Bellah et al., op. cit., footnote 55, pp. 282-283.

<sup>61</sup>For a discussion, see Howard Rheingold, “Virtual Communities,” *Whole Earth Review*, No. 57, Winter 1987, p. 78. In the computing community, “virtual” is a technical term referring to functions realized via computers and software, rather than hardware.

<sup>62</sup>Lee Felsenstein, co-founder of the Community Memory Project, personal communication, Feb. 25, 1988.

<sup>63</sup>Ibid.

<sup>64</sup>See Spencer Rich, “computer Network Links Antipoverty Groups,” *The Washington Post*, July 6, 1989, p. A15.

volved are the Low Income Housing Coalition, the Food Research and Action Center, and the National Coalition for the Homeless.<sup>65</sup>

To participate in a virtual community does not necessarily require a familiarity with computers and computing. The French Minitel system, for example, is extremely user-friendly, linking people through networks of dumb terminals and providing them with easy-to-use gateways and menus.<sup>66</sup> As a result, many French people take advantage of the system.

One appeal of virtual communities is their relative anonymity. Users do not encounter the usual nonverbal cues to help them interpret messages from others.<sup>67</sup> Because members of virtual communities can be anonymous, some believe that such electronic communication can be a "medium without prejudice."<sup>68</sup> Anonymity also allows users "the risk-free opportunity to become someone else," and/or to let down barriers and face-maintaining behaviors that exist in face-to-face conversations.<sup>69</sup> Online interactions allow individuals to share life concerns and participate in debates and discussions for which there is no neighborhood forum. Members sometimes arrange face-to-face meetings, further supporting their relationships.<sup>70</sup>

Virtual communities, however, are neither a panacea nor a perfect substitute for face-to-face contact.<sup>71</sup> To the extent that they replace neighborhood ties, they could contribute to the loss of sharing, interdependence, and mutual concern that neighborhoods have traditionally provided. Moreover, if they required users to have a sophisticated technical knowledge or were available only in a text-based form, their usefulness would be limited to those with the requisite skills.

The anonymity of virtual communities also makes it easier for some people to disregard social norms, which, if history is a good indicator, will give rise to issues concerning what constitutes acceptable content and who should be responsible for assuring that content is within the bounds of propriety. Such problems have already emerged, for example, in the case of 976 telephone chat lines.<sup>72</sup> Cases of fraud and issues of liability might also become more frequent, insofar as electronic communication makes it possible to present a false persona.

To what extent, and under what circumstances, virtual communities will become more popular and more prevalent in the future will depend on a number of factors.<sup>73</sup> Cost is an important one. Generally speaking, telecommunication charges are paid either by individual callers (on their telephone bills or through one of the data network providers) or by the sponsoring organization, if it purchases a toll-free number. Most commercial services charge an hourly connection fee to users. This cost would be higher if information-providers were charged an access fee equivalent to that charged by other users of the communication network. To date, users have successfully resisted such a charge, arguing that it would discourage the development of an information-services industry.<sup>74</sup>

When they are financed primarily through advertising, however, some network services can be provided free. In Boston, for example, Citinet offers users free online information about special interest groups, hearing schedules for State government, and financial information on local businesses. Electronic mailboxes on Citinet cost \$19.95 per year.<sup>75</sup> The

<sup>65</sup>Ibid.

<sup>66</sup>Philippe Perron, "Minitel: The Technology of Success," presentation to OTA, Washington, DC, Oct. 6, 1987.

<sup>67</sup>Alfred Glossbrenner, "A New Medium in the Making: How People Are Shaping (and Being Shaped by) On-Line Communication," *Rain*, November-December, 1985, pp. 28-31.

<sup>68</sup>Ibid., p. 29.

<sup>69</sup>Ibid. See also Roxanne Hiltz and Murray Turoff, *The Network Nation: Human Communication Via Computer* (Reading, MA: Addison-Wesley, 1978). It should be noted, however, that as communities form and users begin to develop stakes in them, norms and sanctions, equivalent to those governing traditional communities, will emerge.

<sup>70</sup>Charles W. Steinfield and Janet Fulk, "Computer-Mediated Systems as Mass Communication Media," paper presented to the Telecommunication Policy Research Conference, Airlie House, VA, October 1988. See also Rheingold, op. cit., footnote 61.

<sup>71</sup>See Amy F. Phillips, "Computer Communications: Success or Failure?" *Human Communication Technology*, vol. 7, 1983, pp. 837-855.

<sup>72</sup>For on discussion, see "Dial-a-Porn Case Argued as Preview of Indecency Case," *Broadcasting*, Apr. 3, 1989, p. 57.

<sup>73</sup>For a discussion of some of these factors from a comparative perspective, see Anne W Branscomb, "Videotex: Global progress and Comparative Policies," *Journal of Communication*, vol. 38, No. 1, Winter 1988, p. 59.

<sup>74</sup>Access Charges for Enhanced Services, 3 FCC Red. 2631 (1988).

<sup>75</sup>Melissa Calvo, "Boston-Citinet refers Users Free On-line Information," *Infoworld*, Apr. 28, 1986, p. 23.

Prodigy Service, offered through a joint venture of IBM and Sears, is also partially financed through advertising.

Access to electronic networks can also be facilitated through the use of gateway services, which help users to identify and connect with groups with whom they want to communicate. And, in fact, it was to encourage the development of such services that Judge Harold Greene relaxed the line-of-business restrictions on the regional Bell operating companies, allowing them to develop and provide videotex gateways. The first two such gateways to be developed are the Transtext-T-Universal Gateway, set up by BellSouth and now operating in Atlanta, and Info-Look, established by Nynex in Burlington, VT.<sup>76</sup>

BellSouth's gateway constitutes part of an adjunct and enhanced network infrastructure inserted into the basic local exchange network. Not only does it give users unlimited free access; it also provides some services free. Moreover, aimed at user-friendliness, the system allows customers equipped with personal computers and a modem to enter the system by using a 10-digit telephone number. In addition, it provides simple menus listing databases and services and handles all billing.

Nynex's Info-Look is less fancy, but many of the customer-services are also less expensive. However, there is a \$3 hourly charge for use. Among the services available on Info-Look are:

... a list of biking trails, for 10 cents per minute; news, interviews, classified ads and ski and travel information from the Burlington Free Press for 15 cents per minute; condensed news from Vermont Business Magazine for 10 cents per minute; interactive political debate for 10 cents per minute, a cat lover's forum for 10 cents per minute; a mailing list of Vermont businesses for 10 cents per minute; skiing conditions for 10 cents per minute; Vermont travel information for 20 cents per minute; and a Vermont hunter's guide for 20 cents per minute.<sup>77</sup>

The lack of both familiarity and technical skills has also served to discourage the general public's use of electronic networks. These kinds of barriers can eventually be overcome, however, as is clearly

evident from the successful development of Minitel in France, cultural differences notwithstanding. What was critical in France was the government's proactive efforts to move the country forward into the information age by subsidizing and supporting the development of a national information infrastructure.<sup>78</sup> Having access to easy-to-use terminals provided by the government, French citizens have not hesitated to establish online connections.

### Cable Community-Access Services

Government policy to encourage the creation and development of local community-based information has a history going back as far as the early postal service. Postal subsidies in the form of letters of exchange were designed to encourage and support the development and viability of local newspapers. In like fashion, early broadcast policy sought to foster the development of local programming. However, given the economies within communication industries, most of these policies proved unsuccessful. One after another, each new media industry that emerged assumed a concentrated and vertically integrated form.

Cable, however, unlike its media predecessors, appeared to be an exception, insofar as it provided an abundance of channel capacity. Thus, with its development, the hope of fostering local programming reemerged. Having access to cable, anyone, anywhere, could be a programmer, or so it seemed.<sup>79</sup> As Michael H. Dann, a consultant to the cable industry, characterized his hopes for cable:

... nearly all the information services that cable will specialize in providing will have nothing to do with watching television as we have known it. You'll be using your monitor for something else—for taking academic courses or for using any or all of the other information services available. And whether this takes the form of something with ethnic appeal or of cooking channels it's something that you would not be getting on commercial television. . . . There are no rules in the cable industry requiring you to have only so many minutes for commercials, with every minute so precious, as it is in broadcasting; the cable companies can be so much looser about the length of commercials, because they have so much channel capacity. Everybody can be on cable longer—the

<sup>76</sup>See Fredric Saunier, "The Public Network Goes On-Line," *Telephony*, Apr. 3, 1989, pp. 26-37.

<sup>77</sup>*Ibid.*, p. 27.

<sup>78</sup>Branscomb, op. cit., footnote 73, p. 83.

<sup>79</sup>James Martin, *The Wired Society* (New York, NY: Prentice Hall, 1976), P. 46.

performer can be on longer, the writer can write longer, the cook can cook longer, the talker can talk longer. And cable is so cheap in comparison to broadcasting that in most communities if you want to get on a public-access channel and hum you can go on.<sup>80</sup>

To bring such aspirations to fruition, many local franchise agreements originally required that local cable systems provide channels for community programming.<sup>81</sup> The different kinds of programming that can be required in such agreements are outlined in box 7-A.

According to one recent survey, 57 percent of all cable operators offer public-access channels, about one-half of which are managed by cable operators.<sup>82</sup> Independent, nonprofit organizations manage an additional 30 percent, and the rest are run by local governments, schools, libraries, and for-profit corporations. An estimated total of between 5,000 to 10,000 hours of original programming is produced for such public access channels each week. One of the most successful local access channels, located in Austin, TX, carries 60 to 70 hours of original programming each week.<sup>83</sup> Community-access facilities are usually funded through a combination of revenues from commercial operations, grants, and donations. About two-thirds are under \$100,000, and one-third have annual operating budgets of less than \$25,000.<sup>84</sup>

Because community-access channels give local citizens an opportunity to create programs for their communities, they can provide an opportunity to influence the local culture and strengthen communal ties. Broadcasts of local high school sports events,

for example, can garner support for local teams and reinforce identification with the local community. Local politicians can increase public awareness by airing local meetings and public events. Community members can reinforce their relationships, joining together to produce media events.

Community-access channels can be especially helpful to minority groups. Much as the foreign language press served to both integrate foreign immigrants and enhance their self-esteem, the production of materials by local ethnic groups can serve to promote community understanding and create a sense of pride in local traditions.<sup>85</sup> This kind of access to production and transmission facilities is critical to minority groups because all too often they have been unable to gain an economic foothold in the media,<sup>86</sup> and as a result they have been either very poorly represented or simply ignored.<sup>87</sup>

Young people can also make particularly good use of local-access channels. As Action for Children's Television has pointed out:

For young people, community cable is an opportunity for service that is disappearing from commercial broadcasting. At a time when the commercial TV networks fail to provide one daily or even weekly children's show Monday through Friday, local cable channels can supply a fertile environment for breeding a new variety of children's television.<sup>88</sup>

Despite the distinct benefits of local access, many community-access channels have been underutilized. Moreover, where they have been in operation, they have often been unable to draw the kinds of audiences required to have a significant impact. A

<sup>80</sup>As reported to, and cited by, Tom Whiteside, "Onward and Upward With the Arts, Cable HI," *The New Yorker*, June 3, 1985, pp. 84-85.

<sup>81</sup> Congress approved such access rules in section 611 of the 1984 Cable Communications Policy Act, codified at 47 U.S.C. sec. 531.

<sup>82</sup>Gregory Epler-Wood and Paul D'Ari, *Cable Programming Resource Director 1987* (Washington, DC: National Federation of Local Cable Programmers, 1987), p. D147.

<sup>83</sup>Sharon Ingraham, National Federation of Local Cable Programmers, personal communication, Feb. 23, 1989.

<sup>84</sup>Epler-Wood and D'Ari, op. cit., footnote 82, p. D144.

<sup>85</sup>See Hanno Hardt, "The Foreign Language Press in American Press History," *Journal of Communication*, vol. 39, No. 2, Spring 1989, pp. 114-131.

<sup>86</sup>At present, there is only a small number of minorities and women in ownership and management positions in the communication industries. This situation has been attributed to many factors, including: 1) minorities were not "at the table" when radio and television licenses were given out; 2) majority owners and managers continue to discriminate; 3) minorities lack the funding to support stations; and 4) minorities are inadequately trained. For a discussion, see Vernon A. Stone, "Women Gain, Black Men Lose Ground in Newsrooms," *RTNDA Communicator*, August 1987, pp. 9-11; Dwight M. Ellis, "Communications at the Crossroads: Parity and Perceptions of Minority Participation," paper presented at the Invitational Conference on Minorities and Communication, Howard University, Washington, DC, June 18, 1987; James Forkay, "Time to Speak Up?" *Advertising Age*, Jan. 4, 1988; and Craig Kuhl, "Corporate America's Color Line," *Cablevision*, June 6, 1988, pp. 34-43.

<sup>87</sup>For the treatment of minority groups in the media, see Eric Barnouw, *A Tower In Babel*, vol. 1 (New York, NY: Oxford University Press, 1966); Herman Gray, "Television and the New Black Man: Black Male Images in Prime-Time Situation Comedy," *Media, Culture and Society*, vol. 8, 1986, pp. 233-242; Susan H. Wilson, "The Missing Comic Strip," *Editor and Publisher*, Apr. 23, 1988, p. 164; and "Women Are Disappearing From TV," *Broadcasting*, Nov. 23, 1987, pp. 52-53.

<sup>88</sup>"Community Cable for and by Children: An ACT Handbook," Action for Children's Television, Newtonville, MA, 1983.

**Box 7-A—Forms of Community Cable**

- . Public access-programming initiated and created by members of the community; the cable company should not interfere in the content of the shows. Public access programming is noncommercial.
- . Educational access—schools, colleges, and libraries can produce their own cable programs; students are usually involved in the production.
- . Government access—local officials can use access to increase citizen awareness by cablecasting town meetings and important public messages.
- Religious access—synagogues and churches can publicize activities and spread their views by producing access programs.
- . Leased access—a kind of rent-a-channel, leased access gives companies or individuals a voice on cable TV. Program content is controlled by those who pay for channel time to get their message out.
- . Local origination (LO)—LO programs are produced by the cable company, which controls the content; young people may or may not be involved in production. LO programming can carry advertising.

SOURCE: Reprinted with permission from "Community Cable for and by Children: An ACT Handbook," by Action for Children's Television (ACT), Cambridge, MA.

number of factors account for this situation, including the lack of funds, skills, technical expertise, and adequate equipment. While most community-access systems receive some funding from local governments or commercial operators, providing additional support for production equipment and distribution may be one way of promoting wider access.

Cable community-access networks may also be underutilized because people are either unaware of their existence or unfamiliar with their use as a public media. Opportunities to participate do not translate into actual participation until community members are motivated to become more active in promoting their cultures. People will have to see themselves as producers as well as audiences, and as publishers as well as readers. For many people, accustomed to the passivity of traditional media, this shift can be very difficult. To bring about the requisite change in attitude, young and old alike will need to be taught critical viewing skills, and to learn their way around the technical, social, economic, and political processes of public and commercial communication systems.<sup>89</sup> Action for Children's Television provides some tips on how to get started, as outlined in box 7-B.

Administrative and political battles can further impede access, especially in cases where there are disputes about content.<sup>90</sup> In some instances, there have been efforts to censor unpopular messages, and in other cases groups have requested time to respond

to the messages prepared by opposing groups. In Kansas City, for example, efforts by local Ku Klux Klan members to air controversial programming brought attempts to change the cable franchise agreement to give the cable operator more discretion in selecting programming.<sup>91</sup>

Also discouraging the use of public-access channels is the intense competition with commercial media. On average, amateurs are unlikely to produce exceptional television programming. And even when they do, they generally have insufficient resources to adequately promote their work. The problem that newcomers face is one of differentiating their work, and of gaining the attention of the appropriate audience at a time when the traditional media are spending more and working harder to attract a viewing audience that is becoming increasingly selective and sophisticated.

What role the Federal Government might play in promoting the use of community-access services in the future is open to question. Despite its long commitment on behalf of the development of local programming, the Federal Government has, of late, been much less inclined to impose carriage requirements on local cable companies. However, were the telephone companies to enter the field in competition with cable companies—and perhaps on a common-carrier basis—the hope for local-access channels will certainly be rekindled.

<sup>89</sup>Ibid.

<sup>90</sup>Retha Hill, "P.G. Cable Performers Await Cue in Off-Camera Dispute," *The Washington Post*, June 25, 1988, p. B1.

<sup>91</sup>"Public Access in Kansas City Heads for Showdown," *Broadcasting*, June 13, 1988, p. 58.



### Box 7-B--Steps for Making Cable TV

The first step for anyone interested in any aspect of making community cable TV is to find out what is offered by the local cable system. Is there a separate access facility, or is the cable studio open to the public? Are formal training sessions held, or do newcomers learn by apprenticeship? Does the cable system provide the videotape, or is that up to the access user? After getting an overview of how access works in your community, you might want to:

- . Speak with others who have been involved in access productions.
- Volunteer to work on an *already existing program* for a better idea of what *goes* into cable production.
- . Check the local library for any media-related materials, especially 'how-to' guides.
- . Enroll in a media workshop, run either by the cable system, the local access foundation, or other community groups (check schools, youth groups, religious organizations, video clubs, and so on).
- Think about what's missing from the community cable lineup that you might provide. What interests could you explore and share by making your *own* cable show?
- . Write a detailed proposal and present it to the access coordinator or the head of local programming. Outline specific ideas and how you would present them. Describe the potential audience for your show.
- Round up a cast and crew. Friends, neighbors, and relatives can all play a part.

SOURCE: Reprinted with permission from "Community Cable for and by Children: An ACT Handbook," by Action for Children's Television (ACT), Cambridge, MA.

### Education and Culture

All societies educate, and education is necessary to maintain and to structure the social order. Education mediates between individuals and society. It is the means by which societies transmit acquired knowledge, attitudes, values, skills, sensibilities, and symbols from one generation to the next—and thus the means by which individuals learn the skills and roles necessary to function in and to influence their society.<sup>92</sup>

In the United States, there has always been support for the idea that education plays an essential societal role. Contrasting the attitude of Americans toward education with that of Europeans, Alexis de Tocqueville, the well-known commentator on American society, noted in 1831:

Everyone I have met up to now, to whatever rank of society they belong, has seemed incapable of imagining that one could doubt the value of education. They never fail to smile when told that this view is not universally accepted in Europe. They agree in thinking that the diffusion of knowledge, useful for all peoples, is absolutely necessary for a free people

like their own, where there is no property qualification for voting or for standing for election. That seemed to be an idea taking root in every head.<sup>93</sup>

The public benefits that Americans have associated with education have changed over time and in different historical circumstances. In the earliest years of American history, education was considered essential for the survival of the new democratic Nation. Later, with the need to acculturate immigrants and to unite a divided Nation in the aftermath of the Civil War, it was considered the means for building a Nation of citizens. At the turn of the century, education was expected to train and socialize American youths for participation in a modern, industrialized society. More recently, Americans have seen in education the solutions to some of the Nation's thorniest social problems.<sup>94</sup>

Throughout its history, the American educational system has been quite successful in adapting to meet the changing needs of society. It has been transformed from a system designed to meet the needs of an agrarian society to one tailored to the needs of an urban, industrialized society. It has been changed, moreover, from a system structured to meet the

<sup>92</sup>See Herbert A. Thelen and Jacob W. Gretzels, "The Social Sciences: Conceptual Framework for Education," *The School Review*, vol. XV, No. 3, Autumn 1957, p. 346. See also Charles E. Bidwell, "The School as Formal Organization," James G. March (ed.), *Handbook of Organizations* (Chicago, IL: Rand McNally & Co., 1955), pp. 969-972.

<sup>93</sup>Alexis de Tocqueville, *Journey to America*, translated by George Lawrence (New York, NY: Anchor Books, 1971).

<sup>94</sup>For a discussion of the social goals attributed to public education, see Rush Welter, *Popular Education and Democratic Thought in America* (New York, NY: Columbia University Press, 1963). See also David Tyack and Elizabeth Hanson, "Conflict and Consensus in American Public Education," *America's Schools: Public and Private*, *Daedalus*, Summer 1981.

educational needs of a privileged few, to one more structured to meet the diverse and sometimes conflicting needs of a growing and heterogeneous population.

Today, however, the American educational system is undergoing a number of stresses. Some originate within the educational system itself; others stem from the profound changes taking place in the larger social environment. Among these developments are:<sup>95</sup>

- an increase in the level of education that individuals need to participate effectively in society;
- an extension of the period of time during which individuals can and need to be educated;
- an increase in the diversity of clientele for education, and thus an increase in the diversity of the demand for education;
- a decline in the public resources available for education, resulting in part from:
  - an increase in the cost of producing education,
  - a questioning of the public benefits associated with public education, and
  - a loss of confidence in the institutions providing education; and
- a general decline in educational achievement, especially when measured against education achievement levels attained in other countries.

Because communication technologies can serve as specialized educational tools, they have always been valued as educational resources. With the

development of the penny press, for example, a number of early communication scholars, among them Charles Horton Cooley, John Dewey, and Robert E. Park, conceived of it, above all, as a source of public education and enlightenment.<sup>96</sup>

The radio was also appreciated for its educational potential, although in allocating spectrum the Federal Radio Commission (FRC) gave a clear preference to commercial stations.<sup>97</sup> As Czitrom describes:

The FRC consistently chose not to view advertisers as special interests. It gave preference to commercial stations while discouraging what it termed “propaganda stations,” particularly those run by labor and educational organizations. The FRC thus reduced the ‘public interest, convenience, and necessity’ phrase to mean the needs of commercial broadcasters.<sup>98</sup>

Given this experience, educators quickly learned that if educational broadcasting was to be successful, educators would need to have a number of channels specifically reserved for such a purpose.<sup>99</sup> Moreover, by the time television came along, educators and others interested in educational broadcasting were much more organized and aggressive in making their demands known.<sup>100</sup> As a result, educators were more successful than they had been with radio in gaining the FCC’s support for educational broadcasting. In March 1951, the FCC announced its intent to reserve 209 channels for noncommercial television stations.

<sup>95</sup>For discussions of these stresses, see U.S. Congress, Office of Technology Assessment, *Informational Technology and Its Impact on American Education*, OTA-CIT-187 (Springfield, VA: National Technical Information Service, November 1982); National Commission on Excellence in Education (Washington, DC, 1983); I. Kirsch and A. Jungeblut, *Literacy: Profiles of America’s Younger Adults*, Final Report, No. 16-PL-01 (Princeton, NJ: National Assessment of Education Progress, 1986).

<sup>96</sup>Czitrom, op. cit., footnote 30, especially ch. 4, “Toward a New Community? Modern Communication in the Social Thought of Charles Horton Cooley, John Dewey, and Robert E. Park,” pp. 90-121.

<sup>97</sup>For a discussion and history, see Robert J. Blakely, *To Serve the Public Interest* (Syracuse, NY: Syracuse University press, 1979). According to Blakely, “By 1925 the commercial radio stations had begun to find in the sale of time for advertising an enduring answer to the problem of financial support, while the educational stations had not. When the Secretary of Commerce adopted policies that created trafficking in licenses in 1925, the number of noncommercial stations began to decline. In 1926, when the impetus for networks to get local affiliates and for local stations to acquire network affiliation was added, the decline quickened.” As Blakely notes, under these circumstances, one of the few educational groups that managed to survive, and which thus came to play a major role in educational broadcasting in the United States, was the State universities and land grant colleges (pp. 53-54).

<sup>98</sup>Czitrom, op. cit., footnote 30, pp. 80-81. And as Blakely adds: “Educational stations also suffered from frequent shifts in their frequencies because of shifts made by the FRC. Commercial stations made money, convertible into political power; educational stations cost money. If their programming was not popular enough to attract sizable audiences, they were hard to justify politically, if it was popular, it provoked political opposition.” Blakely, op. cit., footnote 97, p. 55.

<sup>99</sup>An amendment to this effect, sponsored by Senators Robert F. Wagner and Henry D. Hatfield, had been proposed to the communications Act of 1934, but failed to pass for lack of support. However, in 1945, the FCC decided on its own accord to reserve 20 of the 100 channels available in frequencies higher than 25 megacycles for educational radio.

<sup>100</sup>A central force behind this effort was the Fund for Adult Education, which undertook three basic tasks: 1) securing the reservation of channels; 2) activating the stations; and 3) establishing the Educational and Radio Center. Blakely, op. cit., footnote 97, ch. 4.

Also important in assuring the survival of educational television (ETV) was the early funding by the Ford Foundation, and two key pieces of Federal legislation—the Educational Television Facilities Act, which provided money to activate and expand ETV **stations**, and the All-Channel Television Receiver Act, which served to increase the number of receiving sets on which viewers could receive ultra high frequency (UHF) signals.<sup>101</sup> But the ultimate support for educational TV came only in January 1967 with the passage of the Public Broadcasting Act, which incorporated many of the recommendations made in a national study by the Carnegie Commission on Educational Television.

While past efforts to employ technology for educational purposes have had their detractors, the results have been successful enough to inspire those who are concerned about education today and who look to new technologies for potential solutions. And, indeed, a number of recent analyses suggest that communication technologies could play a very effective role in education.<sup>102</sup> Two of the many educational applications of new information and communication technologies will be considered here: remote learning and desktop publishing of educational materials.

## Remote Learning

Remote learning refers to the provision of mediated instruction at a distance. It can take place in a variety of ways, ranging from the simple exchange of printed material via the postal service to two-way interactive, cross-continental television. It can also occur in a variety of settings. Remote learning can include situations in which a student, or students, participate in a class that is meeting elsewhere, or it can be used to create a virtual classroom where students, although dispersed, interact via telecommunication. Moreover, remote educational materials

can be comprised of any number of media formats, including audio/video presentations, graphics, film clips, real-time video conferencing, computer-aided instruction, etc.

In its recent study, *Linking for Learning*, OTA found that advances in information and communication technologies expand the array of remote-learning options and provide potential solutions to a number of educational needs.<sup>103</sup> According to the study:

In distance learning, technology transports information, not people . . . [It] has changed dramatically in response to new technologies and new needs. Technologies for learning at a distance are also enlarging our definitions of how students learn, where they learn, and who teaches them.<sup>104</sup>

Given technological advances in transmission, and in information storage and reprocessing, remote learning may help to reduce educational disparities among regions. It has been estimated, for example, that one-third of the country's schoolchildren are poorly educated due to the limited staff and resources in small; geographically isolated schools.<sup>105</sup> However, as the OTA study points out, modern, interactive-based distance education can help small, remote communities to meet State-mandated curricular reform, especially requirements for courses in mathematics, science, and foreign languages. For where there is a shortage of qualified teachers and/or too few students at any one site to warrant the hiring of a teacher, remote learning provides an effective alternative.<sup>106</sup>

Remote learning also makes it possible to link all levels of education—from kindergarten through college—allowing for a more optimal use of educational resources and the rethinking of educational curricula. Maine's educational telecommunication network, linking universities, high schools, and

<sup>101</sup>*Ibid.*, p. 143. One major incentive for Federal support was the general concern about the state of **American education in the face of the Soviet's success** with Sputnik.

<sup>102</sup>For an early, but extremely powerful, vision of educational technologies, see Seymour Papert, *Mindstorms* (New York, NY: Basic Books, 1980). See also OTA, op. cit. footnote 95; U.S. Congress, Office of Technology Assessment, *Power On/New Tools for Teaching unlearning*, OTA-SET-379 (Washington, DC: U.S. Government Printing Office, September 1988); "Educational Technology 1987," *Electronic Learning*, October 1987; and Michael Rice, "Toward Improved Computer Software for Education and Entertainment in the Home," Report of an Aspen Institute Planning Meeting, Wye Woods Conference Center, Queenstown, MD, June 3-4, 1987.

<sup>103</sup>See Jason Ohler, "Distance Education and the Transformation of Schooling," OTA contractor report, May 1989.

<sup>104</sup>U.S. Congress, Office of Technology Assessment, *Linking for Learning: A New Course for Education*, OTA-SET-430 (Washington, DC: U.S. Government Printing Office, November 1989), pp. 3-4.

<sup>105</sup>Dean Bradshaw and Patricia Brown, "The Promise of Distance Learning," *Policy Briefs*, No. 8 (San Francisco, CA: Far West Laboratory, 1989).

<sup>106</sup>OTA, op. cit., footnote 104.

newly created outreach centers, is an example of how such connections can lead to expanded services and new relationships.<sup>107</sup>

As more and more educators have become aware of the increased potential of remote learning, the number of States and school districts initiating projects and plans for distance education has increased. For example, in 1987, less than 10 States were promoting distance learning; in 1988, two-thirds reported some involvement.<sup>108</sup> Involvement can entail modest efforts at the local level, or more elaborate undertakings requiring collaboration with regional education service centers and nearby universities and community colleges.

Notwithstanding this growing interest in remote learning, the access of students and teachers to these kinds of facilities is still quite limited. One factor inhibiting access is the lack of a telecommunication infrastructure. Even though cable systems now reach many communities and the telephone network is ubiquitous, few classrooms have the wiring required to take advantage of this telecommunication base. And only 7 percent of all school districts have the capacity to receive satellite signals.

Attention to the quality of instruction is also critical to the successful implementation of remote-learning programs. While remote learning helps students overcome a number of barriers, it can at the same time reinforce students' feelings of isolation, if used as a substitute for traditional teacher/student and student/student interactions. And OTA's analysis shows that not all remote-learning systems afford the same levels of student/teacher interaction. Moreover, students report that distance learning is "harder." When the remote-learning group is large, students complain about how difficult it is to raise questions and obtain help during class time. Most of the students interviewed by OTA preferred instruction at their own schools.

Teacher support and active involvement in the development and deployment of remote-learning

systems is also essential to their success, as the history of earlier educational technologies clearly illustrates.<sup>109</sup> Remote-learning systems can provide teachers with a number of advantages. Many teachers report, for example, that remote teaching has improved their skills, forcing them to become more organized and more innovative. \*10 Moreover, distance learning can provide teachers with a wider reach, allowing them to "meet" and consult with national experts, visit other classrooms, or collaborate and share notes with colleagues 50, or even 5,000, miles away. In such fashion, expert teachers in Iowa welcome prospective teachers into their classrooms via satellite, while two teachers in Connecticut join classrooms via a fiber-optic network to team-teach.<sup>111</sup> On the other hand, teachers have also voiced a number of concerns about the prospects of remote learning. Some are concerned about being replaced by technology. Others are unfamiliar with, and thus uncomfortable using, technology. 112 And others fear a loss of control Over their curriculum and course-work. Involving teachers early in the process of developing remote-learning systems will serve not only to improve the design of these programs, but also to assure their long-term viability.

To facilitate the implementation of remote learning, a number of jurisdictional problems may also need to be resolved. Distance education not only has the potential to decrease the amount of local control over schools; at the same time, many of the new institutional arrangements being established to develop and offer student courses, enrichment activities for classroom instruction, and programs for staff development are now being structured in a more centralized fashion, while the curriculum and in-service training are becoming more and more uniform. Under these circumstances, nationwide accreditation procedures might need to be developed to supplement, or replace, current State-administered standards. However, local and State educational institutions may not be eager to renounce their

<sup>107</sup>Bruce O. Barker, "Distance Learning Case Studies," OTA contractor report, June 1989.

<sup>108</sup>*Ibid.*, see also "Educational Technology 1987: A Report on EL's Seventh Annual Survey Of the StateS," *Electronic Learning*, vol. 1, No. 2, October 1987, p. 41.

<sup>109</sup>For a discussion, see OTA, *op. cit.*, footnote 95.

<sup>110</sup>Barker, *op. cit.*, footnote 107.

<sup>111</sup>*Ibid.*

<sup>112</sup>For a discussion, see Gerald W. Bracey, "Still Anxiety Among Educators Over Computers," *Electronic Learning*, March 1988, p. 20.

control in these matters. \* 13 Thus, educational leadership will be a critical factor for planning efforts that draw together public- and private-sector interests, use resources efficiently, and meet a broad base of educational needs.

Although the Federal Government's role in education is limited, its decisions can have a significant impact on the future of remote learning. Because education is a public good, and thus subject to underfunding, government funding programs can be of particular importance. The Federal funding of Star Schools, for example, has already accelerated the growth of distance learning in the United States.<sup>114</sup> Federal telecommunication policies are also important, as the history of public broadcasting in the United States clearly illustrates. For example, it was only when the government began to reserve spectrum for educational broadcasting that educational groups were able to develop a viable system for educational television.

### Desktop Publishing of Educational Materials

Desktop publishing refers to a simplified publication process that uses a personal computer, word-processing and page-layout software, and a printer to produce documents such as newsletters, newspapers, fliers, and books.<sup>115</sup> Desktop publishing is cheaper and easier than traditional publishing because it eliminates the need for typesetting and mechanical page layout. What-you-see-is-what-you-get software allows users to experiment easily with various type styles and sizes, graphics, and page setups. Educational applications include:

- printing of student newspapers and school publications;
- preparation of more sophisticated audiovisual aids by teachers;
- publication of class notes by teachers to supplement or supplant traditional textbooks;
- student class projects, such as writing and printing of storybooks; and
- publication of university press books.<sup>116</sup>

Desktop publishing systems, when used by teachers to "publish" essays, have helped motivate some students to read and write. Some students have improved their writing ability because they can edit and print their work. One elementary school teacher who uses a desktop publishing system with children who are in need of extra help describes the process:

We work with kids we call "compensatory students," . . . which means they're a little slower than average. To improve reading comprehension, 3rd, 4th, and 5th graders are required to write and publish their own storybooks . . . The kids are really motivated to make their stories interesting and nicely illustrated, especially since they know that after the books are published, the authors will be using them in public readings to the kindergarten and 1st grade.

Making their books has really turned these kids around. Last year's evaluation showed that reading comprehension test scores for our 4th and 5th grades were 50 percent higher than the control group's scores.

Not only has "getting published" built reading, writing and problem-solving skills, it had an enormously positive impact upon the "compensatory student's" self-confidence and self-esteem.<sup>117</sup>

For older students, desktop publishing can cut costs and increase flexibility for student newspapers, giving them more experience in editorial and layout decisionmaking. Desktop systems allow teachers to tailor classroom materials to the needs of students, giving them more control over class content. Teachers, administrators, and community leaders could even use desktop publishing to circulate school information within the community to garner more participation in local educational decisions.

The more successful desktop publishing is, however, the more consideration will need to be given to the issue of equity. The costs of such systems are not negligible. As in the case of deploying computers in the schools, without a Federal policy of support, new technologies are likely to be distributed first in well-to-do areas which, in fact, may not be the school districts most in need of the special benefits

<sup>113</sup>In practice, the locus of control over distance education varies from State to State, and the responsibility for educational telecommunication may reside outside of the educational community.

<sup>114</sup>In addition, the Public Telecommunications Facilities Program established in 1962 at the National Telecommunications and Information Administration has funded the purchase of some equipment used in distance-learning efforts. The Rural Electrification Administration (REA) is providing loans for efforts that have educational components to rural telephone cooperatives in rural Minnesota, the Oklahoma Panhandle, and the Papagos Indian reservation, among others. And Title 111 of the Higher Education Act has supported part of the University of Maine's telecommunication network.

<sup>115</sup>Milt Stanley, "Desktop Publishing," *The Computer Teacher*, November 1987, pp. 46-49; Harold A. Sims, "Desktop Publishing in a PC-Based Environment," *Educational Technology*, August 1987, pp. 6-11; and Deborah Little and Charles Suhor, "School Uses of Desktop Publishing: Asking the Right Questions," *Educational Technology*, August 1987, pp. 35-37.

<sup>116</sup>Robert McCarthy, "Stop the Presses! An Update on Desktop Publishing," *Electronic Learning*, March 1988, pp. 24-29.

<sup>117</sup>As cited in *ibid.*, p. 25.

these technologies afford. Moreover, within schools, priorities will need to be set with respect to how such systems will be used. Should in-house production of tickets, fliers, and programs, which save a school money, take precedence over instructional uses? Should the system be used to reward those who are performing well in school, or to boost the skills of poor performers?

To the extent that desktop publishing is used by teachers to develop their own teaching materials, issues may arise with respect to quality control. If desktop publishing is to offer new opportunities to get involved in the production of educational materials, some new quality-control mechanisms might be needed to encourage the production of well-executed educational materials. Moreover, teachers may require additional training to take full advantage of these technologies. \* 18

### *Religion and Culture*

Religious ideas have often been characterized as the answer to the problem of meaning. As Emile Durkheim wrote about religion: "C'est de la vie serieuse."<sup>119</sup> [It's really serious.] And, according to sociologist Talcott Parsons, religious beliefs:

... are those which are concerned with moral problems of human action, and the features of the human situation, and the place of man and society in the cosmos, which are most relevant to his moral attitudes, and value-orientation process.<sup>120</sup>

In fact, American culture was first conceived of in religious terms.<sup>121</sup> As noted by Bellah et al., the early colonists:

... saw their task of settlement as God-given: an "errand into the wilderness," an experiment in Christian living, the founding of a "city upon a hill."<sup>122</sup>

However, although originally conceived of as a quasi-governmental affair, over time, and in response to changing social forces, religion came to be viewed in America as much more of a private matter. As Bellah et al. describe it:

Religion did not cease to be concerned with moral order, but it operated with a new emphasis on the individual and the voluntary association. Moral teaching came to emphasize self-control rather than deference. It prepared the individual to maintain self-respect and establish ethical commitments in a dangerous and competitive world, not to fit into the stable harmony of an organic community.<sup>123</sup>

Among the many factors contributing to this change were, for example, the political separation of church and state, the breakdown of traditional, communal ties in the wake of industrialization, the growth in the diversity of the population, and the widespread adherence to the philosophy of laissez-faire and individualism.<sup>124</sup>

The privatization of religion in the United States has not significantly affected the level of individual participation in religious activities. Religion continues to be one of the primary ways in which Americans involve themselves in communal life.<sup>125</sup> About 60 percent of the U.S. population claim membership in a church or synagogue, a percentage that has decreased only slightly since 1950.<sup>126</sup> In one annual survey, about 40 percent of the adult population said that they had attended a church or synagogue within the previous 7 days, compared to 42 percent in 1970 and 47 percent in 1960.<sup>127</sup> And, a 1983 Gallup poll reported "a rising tide of interest and involvement in religion among all levels of society," with 57 percent of the respondents report-

<sup>118</sup>Scott Jaschik, "Use of Telecommunications for Instruction Across State Lines Attracting Official Notice," *Chronicle of Higher Education*, Nov. 6, 1985, p. 15.

<sup>119</sup>Emile Durkheim, *The Elementary Form of the Religious Life*, translated by Joseph Ward Swain (London: George Allen & Unwin Ltd., 1976).

<sup>120</sup>Parsons, op. cit., footnote 3, p. 368.

<sup>121</sup>Sacvan Bercovitch, *The Puritan Origins of the American Self* (New Haven, CT: Yale University Press, 1975). See also Boorstin, op. cit., footnote 51, especially ch. 1.

<sup>122</sup>Bellah et al., op. cit., footnote 55, p. 220.

<sup>123</sup>Ibid., p. 222.

<sup>124</sup>Ibid., ch. 9.

<sup>125</sup>As noted by Bellah et al.: "Americans give more money and donate more time to religious bodies and religiously associated organizations than to all other voluntary associations put together." Ibid., p. 219.

<sup>126</sup>1984 *Yearbook of American and Canadian Churches* p.(s) the percentage at 59.6 for 1983 and 59.7 for 1984.

<sup>127</sup>Princeton Religion Research Center, *Emerging Trends* (Princeton, NJ: PRRC, 1983)

ing that they were more interested in religious and spiritual matters than they had been 5 years previously.<sup>128</sup>

As society comes face to face with an increasing number of major ethical issues—such as abortion, dealing with AIDS, and genetic engineering—the links between religion and public policy are, again, likely to become pronounced. Already there are a number of indications that people are moving in this direction.<sup>129</sup> Religious values that have shaped personal perspectives are now being voiced in the political and economic arenas, and organized faith groups are trying to influence public policies on a variety of issues. Public officials and candidates, moreover, are now coming out of the ranks of religious institutions and/or are justifying their behavior on religious as well as social policy grounds.<sup>130</sup>

The problem for society, in this context, is to maintain the requisite balance between diversity and integration. For pluralism in American religion was essentially made possible by a basic underlying agreement about religious values. As Bellah et al. have emphasized:

The fact that most American religions have been biblical and that most, though of course not all, Americans can agree on the term “God” has certainly been helpful in diminishing religious antagonism. But diversity of practice has been seen as legitimate because religion is perceived as a matter of individual choice, with the implicit qualification that the practices themselves accord with public decorum and the adherents abide by the moral standards of community.<sup>131</sup>

Because they exhibit both centrifugal and centripetal tendencies, new communication technologies and how they evolve are likely to significantly affect the balance among religious subcultures and be-

tween religious subcultures and the national culture. Although religious activities have traditionally been centered around face-to-face interactions and sacred texts, religious groups have been among the first to take advantage of new communication media to achieve their ends, and they have done so to considerable effect. The evangelical religious groups of the 1820s, for example, were among the first to exploit improvements in printing technologies—faster presses, stereotyping, and machine-made power—to advance their causes.<sup>132</sup> And remote broadcasts of religious services have been taking place since the introduction of radio in the 1920s. In fact, because religious broadcasting was perceived to be “in the public interest,” most stations and networks offered religious groups some air time on a sustaining (free) basis. \*33

To understand how new communication innovations might change how people participate in religious activities, and thus in the larger production of culture, this section will focus on two applications: electronic networks used by faith groups to coordinate administrative and ministerial activities, and religious programming networks that distribute faith-oriented messages.

### Electronic Networks

Religious organizations are beginning to use electronic connections to broaden and strengthen communication among their administrators and members. The Presbyterian Church (USA), for example,<sup>134</sup> operates Presbynet, an online computer communication network that links religious leaders, staff, and lay people and transmits a variety of church-related discussions. Presbynet was created to promote participation in church dialog and to help mend an ecumenical rift within the church, and it was designed with this goal in mind.<sup>135</sup> It provides toll-free telephone numbers, free connect-time, user-

<sup>128</sup>Gallup Organization poll for the Christian Broadcasting Network, reported in *ibid.*

<sup>129</sup>For discussions, see Kenneth D. Wald, *Religion and Politics in the United States* (New York, NY: St. Martin's Press, 1987); and William F. Fore, *Television and Religion* (Minneapolis, MN: Augsburg Publishing House, 1987).

<sup>130</sup>Wald, *op. cit.*, footnote 129.

<sup>131</sup>Bellah et al., *op. cit.*, footnote 55, p. 225.

<sup>132</sup>Originally local, the evangelical groups centralized their production and distribution activities in New York City because of efficiencies in communicating to the Nation from the leading commercial center. Some even claimed that God had ordained the move to New York. See David P. Nerd, “The Evangelical Origins of Mass Media in America, 1815 -1835,” *Journalism Monographs*, No. 88, 1984, for an account of how early religious groups adopted the newest printing technologies to reach everyone with the same message.

<sup>133</sup>And religious groups were quite successful in their use of the radio. By 1932, there were more than 400 programs. classified by *The Sunday School Times* as “sound and scriptural,” airing on 80 radio stations. *Ibid.*

<sup>134</sup>Many other denominations have similar networks.

<sup>135</sup>Sandra Grear, Director of Communication of the Presbyterian Church (USA), personal communication, Oct. 18, 1986.

friendly software, promotion and support by local church members with computer experience, and even nonelectronic means of learning about what was being said on the system. Most systems consist primarily of a central computer with conferencing and communication software. Using their computers and modems, members can dial the central computer through the public telephone network to share private messages, public announcements and articles, religious ideas, graphic information, and requests for information. The combination of electronic mail, computer conferencing, and bulletin boards is supported by pooled funds.<sup>136</sup>

Electronic networks could provide new opportunities for involvement in church activities. For church leaders and administrators, the networks are a new way to share ideas, discuss common problems, and coordinate activities. Successful programs developed in one area of the country can be shared with peers throughout the Nation and even internationally, cutting costs for all and encouraging efficient use of effort. For lay members, the networks can provide a new set of contacts and make discussions of faith-related issues more accessible. People who are more aware of and active in their church activities have more impact on church actions, and can extend the effects within their own social circles.

Networks can also be used to link church communities of different sects, providing a means for cooperation and ongoing dialog. The networks of a number of religious groups are linked, for example, via Ecnnet, an umbrella network that is sponsored by the National Council of the Churches of Christ.<sup>137</sup> Conferences range from those having to do with traditional religious functions to those addressing broad social issues. Conference topics are set up by individual participants, and conversations are for the

most part among the lay members of the church, although there is a predominance of those interested in computers and communication technology.<sup>138</sup>

One problem with these networks is that they tend to exclude those who lack the necessary computer resources or are unfamiliar with technology. Thus, some people may become cut off from religious dialog and lose some of their input into church affairs. Moreover, if networks are given precedence over face-to-face and local contact, interactions over the network could weaken ties to local church groups and community, depriving some members of social interaction and the spiritual guidance offered by more traditional forms of interaction.

### Religious-Programming Networks

Until the 1970s, most video religious programming consisted of individual shows produced by faith groups to carry their message to the broadcast audience. With the rising costs of video-program production and the growing penetration of cable, a number of cable channels emerged for religious programming. Many of these relied on charismatic evangelists and on-air fundraising until scandals and falling ratings led several of the leading networks to reposition themselves.<sup>139</sup> Now a number of evangelical networks, such as the Reverend Jerry Falwell's Family Net and The Christian Broadcasting Network, broadcast a wide array of talk, music, and variety shows in addition to evangelical programs.<sup>140</sup> Mainline churches also support program networks like the Catholic Eternal Word Television Network and the Jewish Television Network, and several have recently joined together to establish an interfaith cable network, the Vision Interfaith Satellite Network (VISN).<sup>141</sup>

Faith groups, then, have taken advantage of the increased channel capacity offered by cable (and other technologies) to reach larger audiences with

<sup>136</sup>Ibid.

<sup>137</sup>David Pomeroy, National Council of the Churches of Christ, personal communication, June 13, 1989.

<sup>138</sup>Ibid.

<sup>139</sup>According to the memorandum, *The Inspirational Network*, circulated by PTL, an evangelical is "an individual who, in addition to having a 'born again,' or 'life changing spiritual experience,' believes in the literal truth of the Bible, has repented of sin and received the Holy Spirit of Jesus Christ, which then literally indwells the individual." Jeffrey K. Hadden and Anson Shupe, *Televangelist: Power and Politics on God's Frontier* (New York, NY: Henry Holt & Co., 1988). According to John Motavelli: "Virtually all the major TV evangelists have faced sharp declines in their popularity since 1980. CBN's Robertson has seen his approval rating drop from 65 percent to 50 percent; Oral Roberts has dropped even more dramatically, from 66 percent to 28 percent; and Jimmy Swaggart has plummeted from 76 percent to 44 percent." John Motavelli, "Born Again: Religious Channels Emphasizing Entertainment to Broaden Appeal," *Cablevision*, Sept. 28, 1987, pp. 20-22.

<sup>140</sup>For example, about 25 percent of the Christian Broadcasting Network's programs are religious. "CBN at Age 11 Drops the Classics for Original programs," *Television/Radio Age*, Apr. 18, 1988, p. 34; and "Falwell Backs New Religious Cable Channel," *Electronic Media*, May 2, 1988, p. 3.

<sup>141</sup>Laura Landro, "As Evangelists Fade on Cable TV, Mainline Churches Claim the Air," *The Wall Street Journal*, Mar. 9, 1988, p. 32.



their messages. Their founders see the networks as a means of reasserting the role of the church in shaping cultural values.<sup>142</sup> Increased contact with audiences could also challenge churches to be more accountable to viewers' current concerns and conditions.<sup>143</sup>

While this opens new opportunities for faith groups to participate in cultural production, it also raises several issues. It is possible that new networks will simply escalate a ratings war among religious broadcasting groups.<sup>144</sup> Interfaith networks, especially if they are backed by powerful cable companies, could replace other religious programming and therefore narrow the opportunities for independent participation.<sup>145</sup> Some church leaders worry that "electronic evangelism" is not true evangelism, but instead "makes religion some thing you can soak up, like a sponge, rather than work at."<sup>146</sup> Some local church officials worry that national or international "electronic churches" will steal members away from local churches, turning members into passive donors rather than activists in local religious affairs.<sup>147</sup> The degree of coordination between local churches and national program producers will help determine the extent to which this phenomenon occurs. \*48 Others see churches' increased cultural role as signifying a larger political role as well. Some either feel that religious organizations should not be so involved in politics or fear the specific political stands that such organizations might take.<sup>149</sup> This,

and the profitability of some religious broadcast networks, has raised questions about the appropriateness of tax exemptions for religious broadcasters and politically active churches.

### *Entertainment and Popular Culture*

Although often thought of as a personal activity or a business enterprise, entertainment performs a significant cultural function as well.<sup>150</sup> Like any form of play, entertainment inculcates the predominant cultural values and socializes individuals to execute certain roles.<sup>151</sup> In fact, participating in entertainment is a form of ritual. It entails:

. the collective reenactment of symbolic archetypes that express the shared emotions and ideas of a given culture. \*52

Participants witness and reaffirm the basic myths and stories that structure their experience, playing them out in circumstances that are familiar or believable to an audience.

Given the critical impact that entertainment can have on the lives of individuals, and on society in general, the creators of content can exert a great deal of influence. For this reason, policy makers, elites, social critics, and social observers throughout history have, in general, paid particular attention to the rules that govern the creation and distribution of entertainment content.<sup>153</sup> Concerns have been par-

<sup>142</sup>Will Bane, acting manager of VISN, personal communication, June 22, 1988.

<sup>143</sup>Dan Matthews, Trinity Church and Board Chair of VISN, personal communication, June 19, 1988.

<sup>144</sup>Peter G. Horsfield, *Religious Television: The American Experience* (New York, NY: Longman, 1984), p. 169.

<sup>145</sup>Officials of the PTL cable network, for example, mounted a campaign against the new VISN network to convince cable operators that the new mainstream network was unnecessary. VISN founders see their network as a supplement to, not a replacement for, evangelical networks. "New Multifaith Cable Service Angers PTL," *TV Guide*, Apr. 23-29, 1988, p. A1; "Cable's Vision," *Broadcasting*, Mar. 21, 1988, p. 56; and K. Harold Ellens, *Models of Religious Broadcasting* (Grand Rapids, MI: William Eerdmans Publishing Co., 1974), p. 144. For programming networks, access to the means of producing programs is as important as access to the finished programs. Because the number of cable channels on a system is limited, and competition for carriage on those channels is becoming severe, it is likely that competition among faith groups will increase.

<sup>146</sup>Fore, op. cit., footnote 129.

<sup>147</sup>Ibid. However, Fore also notes that the audience for religious broadcasts is made up largely of people who are also active church-goers, indicating that electronic churches are more likely to reinforce religious activities than to undermine them.

<sup>148</sup>One study found that religious programs mention local churches in one out of four programs, and encourage local attendance in one out of eight programs. George Gerbner et al., "Religion on Television and in the Lives of Viewers," report for the Ad Hoc Committee on Religious Television Research, National Council of Churches of Christ, New York, 1984.

<sup>149</sup>Wald, op. cit., footnote 129. See also David S. Broder, "Will Evangelistic Politics Fade?" *The Washington Post*, May 4, 1988.

<sup>150</sup>For one discussion of the development of entertainment as a cultural form, see Harold Mendelsohn and H.T. Spetnagel, "Entertainment as a Sociological Enterprise," Percy Tannenbaum (ed.), *The Entertainment Functions of Television* (Hillsdale, NJ: Lawrence Erlbaum Associates, 1980), pp. 13-20.

<sup>151</sup>See Clifford Geertz, *The Interpretation of Cultures* (New York, NY: Basic Books, 1973).

<sup>152</sup>Michael Real, *Mass Mediated Culture* (New York, NY: Prentice-Hall, 1977), p. 6.

<sup>153</sup>The granting of copyright in England, for example, was originally designed as a mechanism for censorship.

ticularly great with respect to mass media, which allow small groups of individuals to speak to large and distant audiences.<sup>154</sup>

Many people were concerned, for example, by the advent and popularity of motion pictures. The 1914 warning of writer, Frederick C. Howe, was typical:

Commercialized leisure is moulding our civilization—not as it should be moulded but as commerce dictates . . . And leisure must be controlled by the community, if it is to become an agency of civilization rather than the reverse.<sup>155</sup>

To address such concerns, many municipalities and States set up local censorship boards “to stem the glorification of crime and sex on the nation’s screen.”<sup>156</sup>

Not surprisingly, similar concerns about the negative impact of the mass media on American culture continue to be voiced today. The media have been criticized, for example, for fostering consumerism, supporting the “powers-that-be,” reinforcing negative stereotypes, downplaying social issues and mollifying social concerns, and contributing to the decline in popular taste.<sup>\*57</sup>

However, entertainment media are not necessarily or inherently conservative; they can also serve to engender and manage cultural change. By virtue of their power to select and interpret content, media can subtly introduce new, and even controversial, ideas.<sup>158</sup> But, whether or not the media will lead or follow depends to a large degree on the structure of the media industry, how it is financed, and the

relationship of key media industry players with other elite groups in society. Thus Ball-Rokeach and Cantor argue that it is impossible to know what messages will reach an audience without looking at the sociology of the organizations involved in mass Communication.<sup>159</sup> Looking at the United States, they note for example:

. . . in a free enterprise system as it exists in the United States, those who control the means of communication (for example, newspapers, radio stations, television stations) and the means of distribution (such as networks and distributors) must depend on advertisers and other sources of financial support (such as financiers and international trade agents) as well as creators. To make matters even more complex, they must also depend upon the judicial, regulatory, and legislative agencies to continue to provide a situation that is conducive to their production process. Power over what is shown rests finally with those who own or finance the media, rather than with the individual creators.<sup>160</sup>

We find, therefore, that in the United States today there are a number of people who are concerned not only because the media industry is, itself, becoming increasingly concentrated and vertically integrated; but also because the leaders in these industries are becoming increasingly linked and interconnected with other industrial groups. As Ben Bagdikian describes:

A handful of mammoth private organizations have begun to dominate the world’s mass media. Most of them confidently announce that by the 1990s they—five to ten corporate giants—will control most of the

<sup>154</sup>For the classic discussion of the differential impact of media, see the work of Harold Innis, op. cit., footnote 11. For an explication and interpretation of Innis’s work, see James W. Carey, “Space, Time, and Communication: A Tribute to Harold Innis,” Carey (ed.), op. cit., footnote 50, ch. 6. For some of the earlier works on media effects in the United States, see Paul Lazarsfeld, *Radio and the Printed Page* (New York, NY: Columbia University Office of Radio Research, 1940); and Paul B. Lazarsfeld, B. Berelson, and H. Gaudet, *The People’s Choice: How the Voter Makes Up His Mind in a Presidential Campaign* (New York, NY: Guell, Sloan and Pearce, 1944).

<sup>155</sup>As cited in Czitrom, op. cit., footnote 30, p. 44.

<sup>156</sup>James J. Parker, “The Organizational Environment of the Motion Picture Sector,” in Ball-Rokeach and Cantor (eds.), op. cit., footnote 48, p. 146. Although called onto act, the Federal Government did not become involved in censorship until U.S. entry into the World War II. And, in fact, the movie industry took steps to avoid government censorship by promoting a private civic organization, the National Board of Censorship of Motion Pictures, to perform this role. Czitrom, op. cit., footnote 30, pp. 52-55.

<sup>157</sup>For some discussions, see Arthur A. Berger, *Television in Society* (New Brunswick, NJ: Transaction Books, 1986); Mark Crispin Miller, *Boxed In: The Culture of TV* (Evanston, IL: Northwestern University Press, 1988); and Ben H. Bagdikian, *The Media Monopoly* (Boston, MA: Beacon Press, 2d ed., 1987).

<sup>158</sup>As Thelma McCormack notes, the literature on how the media are used by dominant groups to reinforce socioeconomic divisions and legitimate cultural values is quite extensive. However, there has been much less thorough and empirical investigation devoted to the subject of how, and under what circumstances, media can serve to bring about social change. For a discussion, see Thelma McCormack, “Reflections on the Lost Vision of Communications Theory,” in Ball-Rokeach and Cantor (eds.), op. cit., footnote 48, pp. 34-42. For one study that makes this case, see Elisabeth Noelle-Neumann, “Mass Media and Social Change in Developed Societies,” Elihu Katz and Tamas Szecsko, *Mass Media and Social Change* (London: Sage Publications International, 1981). On the basis of her analysis of the effects of the media in the Federal Republic, the author claims that under circumstances where there is a significant degree of ‘media consonance,’ the media act as agents of change.

<sup>159</sup>Sandra J. Ball-Rokeach and Muriel Cantor, “The Media and the Social Fabric,” Ball-Rokeach and Cantor (eds.), Op. Cit., footnote 48, p. 15.

<sup>160</sup>Ibid.

world's important newspapers, magazines, books, broadcast stations, movies, recordings and videocassettes . . .

Many of the media magnates also indulge in another form of synergism; interlocks with financial and commercial operations that are affected by news, opinion and popular culture, and which can be either promoted or protected by the parent firm's media. While Capital Cities/ABC, for example, controls the ESPN cable channel, RJR Nabisco, the global food and tobacco company (and an important advertiser with ABC), has a 20 percent interest in ESPN. General Electric, a second-level giant in the media through its ownership of NBC, is a first-rank giant in world military and nuclear reactor production.<sup>161</sup>

The impact of the media on culture will also depend on the nature of the audience.<sup>162</sup> Audiences are not passive receivers of content, as was once believed. As J.T. Klapper has pointed out,<sup>163</sup> people tend to interpret content differently depending on their background, expectations, peer relations, and the context in which they are operating. On this point, Karl Erik Rosengren notes, for example:

Mass media use is not independent of other socializing agents. It may, for example, be affected by the shortcomings of other socializing agents—school, for instance, or the family. There is an interaction not only between the individual and socializing agents, then, but also among the socializing agents themselves.<sup>164</sup>

People can also exert some leverage in determining the kind of content made available to them. Through their purchases, for example, audiences will show a preference for some forms of media, and some kinds of content, over others.<sup>165</sup> Moreover, individual members of audiences can also join together to lobby media organizations about content,

an approach that has been successful in a number of instances in the past.<sup>166</sup> Audiences also have control over the content they absorb; whether reading a book or watching a film or movie, an audience will be selective in its perception of actions and events.<sup>167</sup>

In democratic societies, efforts to promote a diversity of cultural content, and to guard against any one group playing an inordinate role in its development, have focused on structuring organizational arrangements and the relationships among players in the communication system. One way that the government in the United States sought to structure these relationships was by establishing and setting limits on many forms of ownership rights.

New technologies can also restructure these relationships, altering the balance of who can participate, and how, in the production of culture. Two such technological applications will be considered here. One of these, pay-per-view television, could enhance the audience's role in determining content. The other, digital sampling and editing, could reduce the barriers for creators wishing to enter the cultural-production process.

### Pay-Per-View Television

Pay-per-view (PPV) refers to the sale of programs to viewers in their homes, on an unbundled, show-by-show basis. Theatrical exhibition and videocassette rentals are primitive forms of PPV, but new technologies are making PPV more convenient. Cable is the most common means of providing it, and about one-half dozen PPV networks are now offering programming to cable systems serving approximately 10 million cable households.<sup>168</sup> In

<sup>161</sup>Ben H. Bagdikian, "The Lords of the Global Village," *The Nation*, June 12, 1989, pp. 805.815.

<sup>162</sup>For a discussion, see Muriel G. Cater and Joel M. Cantor, "Audience Composition and Television Content: The Mass Audience Revisited," Ball-Rokeach and Cantor (eds.), op. cit., footnote 48.

<sup>163</sup>J. T. Klapper, *The Effects of Mass Communication* (New York, NY: Free Press, 1960).

<sup>164</sup>Karl Erik Rosengren, "Linking Culture and other Societal Systems," Ball-Rokeach and Cantor (eds.), op. cit., footnote 48, p. 91.

<sup>165</sup>The feedback does not have to be this direct. Tracing the changing content of American soap operas in relationship to a changing audience, Cantor and Cantor note, for example: "In free enterprise under the capitalist system, the important influence on how content is created is who the creators intend to be the target audience (or audiences) of consumers, not necessarily the actual audience(s) attracted to particular programs . . . We do not postulate that there is a direct, immediate, linear causal relationship between the target audience and the content they receive but rather a dynamic interaction based on several different kinds of feedback from the audience over time to the creators." Cantor and Cantor, op. cit., footnote 162, p. 219.

<sup>166</sup>For a discussion of the role of media interest groups, see Kathryn Montgomery, "The Political Struggle for Prime Time," Ball-Rokeach and Cantor (eds.), op. cit., footnote 48. As the author notes, minority groups seeking fair representation have had more success than groups such as the PTA that have criticized the media for its overemphasis on sex and violence. She explains this discrepancy in terms of the media's desire to maximize audience size. Incorporating minority points of view may attract new audiences, whereas deleting sex and violence might have the opposite effect.

<sup>167</sup>& notion of selective perception was first introduced in 1944 by Paul B. Lazarsfeld et al., op. cit., footnote 154. More recently, many have said that it is less applicable to television because as a medium it is more forceful and direct. For a discussion, see Noelle-Neumann, op. cit., footnote 158.

<sup>168</sup>Alan Breznick, "Pay-Per-View Networks," *Channels Field Guide* 1988, November/December 1987.

most of these systems, movies are shown at specified times, and subscribers can elect to pay to receive them at those times.

Ordering and billing capabilities are key to the development of PPV. Many systems employ service representatives who answer subscribers' telephone orders and arrange for delivery of programs; other systems have automated ordering systems. A more recent development is the use of automatic number identification (ANI), a service offered by telephone companies to cable operators that automatically identifies the caller and thereby streamlines ordering and billing. "Impulse" systems provide even more convenience—with addressable converters in their homes, viewers can simply tune into programs and be billed automatically.<sup>169</sup> Impulse systems are more expensive to install, but generate more than twice as many subscriber purchases than nonimpulse systems.<sup>170</sup> As fiber-optic cable is laid to residential households, it will be possible to provide "video on demand"—PPV in which viewers can order content from catalogs, receive programs at their convenience, and be billed automatically.<sup>171</sup>

PPV is a new means for distributing entertainment content. It could serve, however, as much more than a convenient way to receive programming. It could also give viewers more control, allowing them to be more selective when receiving content. In fact, by all accounts viewers are using new technologies to do just that.<sup>172</sup> Moreover, because these technologies link the user more closely to the media provider, audience feedback with respect to content can be more direct.

In the short run, it is unlikely that PPV will have a direct effect on the range of media content. To date, the greatest demand for PPV programs has been for hit titles readily available in other media, although a few shows aired only for PPV—wrestling matches, fights, and concerts—have attracted small audiences. PPV companies have also experienced some difficulty raising capital, with slow growth putting pressure on their cash outlays and increasing their debt service.<sup>173</sup> Mergers have been suggested as a solution to these financial problems, but greater vertical integration in the media industry would be counterproductive, serving to impede the development of a wider range of content.<sup>174</sup>

PPV might become more popular over time, however. If this were to occur on a large scale, it could undermine the economic basis of network television—advertising.<sup>175</sup> Without advertising, the cost of entertainment would be considerably higher for some, giving rise to issues concerning equity of access. Moreover, a PPV entertainment environment would make the market the final arbitrator of the Nation's cultural needs. While such an outcome would be welcomed by some, others contend that there exists a public interest above and beyond consumer choice.<sup>176</sup>

### Digital Sampling and Editing

Machine tools enhanced people's ability to perform physical tasks. Similarly, new information and communication technologies will enhance their ability to carry out intellectual pursuits. Among other things, these technologies will allow more

<sup>169</sup>The Kanematsu-Gosho's "Sprucer" 300 system employed by the New York Times' New Jersey cable systems is an example of an impulse system. See John Motavalli, "PPV at the Next Plateau: How Big a Business is It?" *Cablevision*, July 6, 1987, pp. 36-38.

<sup>170</sup>Nancy Brumback, "PPV Proves Hot Topic at New England Meeting," *Multichannel News*, Aug. 3, 1981, p. 17.

<sup>171</sup>In June 1988, GTE filed an application for permission to build an optical fiber testbed to test several video services, including video on demand, in Cerritos, CA. "GTE Files Fiber Test Bid," *Television Digest*, vol. 29, No. 27, July 4, 1988, p. 6.

<sup>172</sup>See, for example, Glen Collins, "From a Vast Wasteland to a Brave New World," *The New York Times*, Mar. 20, 1988. See also Peter Ainslie, "Confronting a Nation of Grazers," *Channels*, September 1988, p. 54. So far, the greatest demand for PPV programs has been for hit titles readily available in other media, suggesting that PPV, at least in the short run, will not dramatically increase the range of program fare. A few shows aired only on PPV—wrestling matches, fights, and concerts—have gathered small audiences, however.

<sup>173</sup>Wayne Friedman, "Expected PPV Merger Provokes Hope, Skepticism," *Cablevision*, Feb. 15, 1988.

<sup>174</sup>Most recently, for example, Walt Disney Pictures and Television invested equally (14.3%) with multiple system cable operators American Television and Communication, ContinentalCablevision, Cox Communications, Newhouse Broadcasting, Telecable, and Viacom Cable in the New York-based pay-per-view system, Viewer's Choice. "Disney Buys Into Viewer's Choice," *Broadcasting*, June 26, 1989, p. 53.

<sup>175</sup>As Jay Blumler points out: "Despite the increased number of viewing options, the amount of time that people spend with television is not very elastic. [This being the case] the audience that one programmer attracts will typically be gained at the expense of some other provider. The chase for audiences is now almost a zero-sum game." Jay Blumler, "The Role of Public Policy in the New Television Marketplace," Benton Foundation Project on Communications and Information Policy Options, paper no. 1, Washington, DC, 1989, p. 9.

<sup>176</sup>For a discussion, see *ibid.*; and Victor E. Ferrall, Jr., "The Impact of Television Deregulation on Private and Public Interests," *Journal of Communication*, vol. 39, No. 1, Winter 1989, pp. 8-38.

people to participate in the creative processes and to share the products of their work. As Ithiel de Sola Pool noted:

The technologies used for self-expression, human intercourse, and recording of knowledge are in unprecedented flux. A panoply of electronic devices puts at everyone's hand capacities far beyond anything that the printing press could offer. Machines that think, that bring great libraries into anybody's study, that allow discourse among persons a half-world apart, are expanders of human culture. They allow people to do anything that could be done with communications tools of the past, and many more things too.<sup>177</sup>

One particular technological application that may enhance access to the process of cultural production is digital sampling. Digital sampling and editing can be thought of as akin to genetic engineering—manipulating and recombining sound and video images instead of genetic material. In digital sampling, sounds are converted to digital signals that are stored as information in computer files. These signals can then be processed in a number of ways—the pitch, volume, and sequences altered to create new sounds on the basis of the original recording. Digital video images can be similarly processed—items can be moved or removed, faces can be altered, and colors can be changed. With these techniques, existing images, sounds, and performances become more than single performances—they are also the basis for new artistic works.

Computer and video technologies are having such an effect on film editing. With tools such as EditDroid, developed by Lucasfilms, the arduous task of editing thousands of feet of film is simplified by this kind of electronic snipping and pasting.<sup>178</sup> By computerizing the editing process, a film artist can rearrange footage in the same way a writer rearranges words on the word-processor: inserting and deleting images frame by frame; taking those sequences from one place and shifting them to

another; and scrolling through sequences again and again. All this is done in a matter of seconds.<sup>179</sup> As in creating texts or developing online databases and information services, films can also be edited, merged, and re-formed. In the same fashion, old films, stored tape footage, and other archival material can all serve as the basis for new derivative products and creative works.

Electronic snipping and pasting has also altered the world of the still-image photographer. Using laser and computer technologies to scan original photographs and convert them into digital data, one can manipulate the “no-longer-photographic” image in very sophisticated ways.<sup>180</sup> The same technologies can also transmit photographs electronically to printers in remote locations.

The production of music and sound is equally amenable to electronic snipping and pasting. Using the ability to store recording sound digitally and gain increased digital control of that sound, the musician can mix and match not only sounds, but also rhythms and pitch. According to composer Michael Kowalski, these new tools allow for:

... unprecedented access to reproducing, copying and editing sound—an ability to take tiny snippets of sound, anywhere from a twenty thousandth of a second of a sound to the whole piece of music, and manipulate it to your heart's content.<sup>181</sup>

However, these technological advances also have the potential to damage creators' interests. The same images and sounds that the artist, photographer, or musician has stored to use, manipulate, revise, and reproduce can also be manipulated, revised, copied, and used in a multitude of ways by others, with or without their permission.<sup>182</sup> Some creators worry that a:

... cavalier attitude will develop toward taking whatever you want and doing whatever you want with it.<sup>183</sup>

<sup>177</sup>Ithiel de Sola Pool, *Technologies of Freedom* (Cambridge, MA: The Belknap Press of Harvard University Press, 1983), P. 226.

<sup>178</sup>Experts point out that film editing is a major component in the making of a film. It can take as long as the shooting itself. A typical finished feature film consists of 10,000 feet of film on 6 reels, the result of as many as 2,000 splices from the original footage. Stuart Games, “Lights, Cameras . . . Computers,” *Discover*, August 1984, pp. 76-79.

<sup>179</sup>Ibid.

<sup>180</sup>Steward Brand, Kevin Kelly, and Jay Kinney. “Digital Retouching,” *Whole Earth Review*, No. 47, July 1985, pp. 42-47.

<sup>181</sup>Michael Kowalski, OTA Workshop on Technologies for Information creation, Dec. 6, 1984.

<sup>182</sup>U.S. Congress, Office of Technology Assessment, *Intellectual Property Rights in an Age of Electronics and Information*, OTA-CIT-302 (Springfield, VA: National Technical Information Service, April 1986).

<sup>183</sup>Lauretta Jones and Bonnie Sullivan, graphic artists in New York City, personal communication, March 1985.

This attitude has already surfaced within the artistic community itself, as well as in advertising and publishing.<sup>184</sup> Although many of these innovative tools for cutting and pasting are still relatively expensive and unavailable, they may be more accessible in the future. With wider deployment of

such techniques, artists, photographers, and musicians may find it increasingly difficult to track or trace the uses of their work. Hence, by virtue of their ability to increase access, these technologies may pose problems for the intellectual property system and for the integrity of the creator's work.

---

<sup>184</sup>Carol Risher and Jon Baumgarten, "The American Experience: Two Views of Electrocopying," *Publishers Weekly*, July 14, 1989, pp. 52-53.

## **Chapter 8**

# **Communication and the Individual**

## CONTENTS

	<i>Page</i>
INTRODUCTION .....	211
THE COMMUNICATION NEEDS OF INDIVIDUALS .....	211
Approach 1: Measuring Today's Behavioral a Blueprint for the Future .....	212
Approach 2: Asking People What They Want and Why .....	213
Approach 3: Considering Social and Demographic Trends in Forecasting Future Needs.....	213
Approach 4: Trying To Identify Why People Use Existing Communication Systems.	215
OPPORTUNITIES PROVIDED BY THE NEW COMMUNICATION TECHNOLOGIES .....	216
Education and Self-Improvement .....	216
Counseling and Psychological Support .....	218
Recreation and Leisure, Entertainment and Self-Expression. ....	219
Social Interaction .....	221
Economic Participation .....	223
Personal Business .....	225
Controlling and Manipulating Technology-Mediated Interactions .....	227
Potential for Overcoming Barriers to Physical Mobility. ....	228
KEY FACTORS SHAPING IMPLICATIONS FOR THE INDIVIDUAL .....	229
Technological Literacy Factors .....	229
Socioeconomic Factors .....	232
System Design and Support Factors .....	235

### Box

<b>Box</b>	<i>Page</i>
8-A. Data on Technology Use. ....	214



# Communication and the Individual

## INTRODUCTION

Virtually every aspect of an individual's existence involves communication. Whether trying to make a decision, keep in touch, hunt for a job, or relax at home, individuals are highly dependent on the web of communication systems and the mechanisms that surround them. Individuals' lives are shaped in part by the communication tools available to them, and by the information networks in which they participate.

Traditionally, technological innovations have been a mixed blessing for the individual. New technologies have improved the lives of some; posed problems for others; and changed the nature of daily life for almost everyone. The advent of television, for example, may have brought greater awareness and companionship to many people, but it also brought the questionable impacts of advertising, graphic violence, and TV-delivered morality.

Communication systems used by individuals have evolved in response to and in tandem with social and demographic change. Today's trends foreshadow future communication needs and suggest directions for the adoption of technology. For example, the U.S. population is aging and becoming more ethnically and linguistically heterogeneous. Thus, communication systems may be called on more and more to compensate for lack of mobility, or to translate or customize certain information.

New communication capabilities may offer dazzling opportunities to amplify the powers of human talent, substitute convenience for drudgery, foster social interaction, make education more universally and continuously available, provide new flexibility in working and living arrangements, and so on. At the same time, however, they may threaten to erode personal privacy, sharpen social inequalities, and create frustration and isolation. Moreover, the technologies that create opportunities for some may create problems for others.

As new capabilities emerge, conflicts will arise among stakeholders over priorities in implementing

the technology. New control and screening capabilities in the telephone system, for example, may pit guardians of personal privacy against direct-marketers. New tools for creative expression may cause friction between individuals who want access to raw informational material and those who hold the intellectual property rights to that material.

This chapter will examine the opportunities and problems that the new technologies pose from the point of view of the individual. It will:

- . describe different ways of looking at individual communication needs;
- . examine a number of opportunities and limitations posed for individuals by new technologies; and
- . examine some of the factors, such as literacy and ability to pay, that may determine whether and how individuals will be able to use the new systems.

## THE COMMUNICATION NEEDS OF INDIVIDUALS

Gauging the communication needs and desires of individuals has always been difficult. The history of modern communication media is strewn with embarrassing predictions and assumptions, such as Harry M. Warner's 1927 statement: "Who the hell wants to hear actors talk?"

Nonetheless, analysts with a variety of perspectives--public policy, marketing, academic, and consumer advocacy--continue to try to identify and define "communication needs." There are several approaches to this task, each with its own strengths and weaknesses.<sup>1</sup> This section discusses four distinct approaches:

1. measuring today's behavior as a blueprint for the future;
2. asking people what they want and why;
3. considering demographic and social trends in forecasting future needs; and
4. trying to identify the fundamental, underlying reasons why people communicate.

<sup>1</sup>For a discussion of **battles** between behaviorists and cognitive psychologists over how to measure **needs**, see "what **Do People Want, Anyway?**" *The New York Times*, Nov. 8, 1987, p. 11.

**Approach 1:  
Measuring Today's Behavior as a Blueprint  
for the Future**

Looking at how people presently communicate is perhaps the most obvious way to determine how they might want or need to communicate in the future. It is also, on the surface, the most straightforward and objective approach. Furthermore, technology is quickly improving our ability to measure some types of communication behavior. Libraries with new online circulation systems, for example, can better find out which books are circulating, and among which user populations.<sup>2</sup>

However, controversy over television's rating systems indicate that this approach is not without its problems.<sup>3</sup> Measuring behavior and determining what the measurements really mean are both difficult. While it is often possible to figure out who is using a communication system, it is not always easy to tell what people are using it for. In other words, you can find out how many people are buying the newspaper, but not necessarily what sections they are reading.<sup>4</sup> Or you can tell definitively how many people are using the telephone, at what time of day, but not what they are talking about. Nor are data on current behavior always available in a comprehensive form, both because of their value as a proprietary strategic weapon in the marketplace and because this kind of information is not always collected systematically. When data are available, they

are often contradictory. For example, a recent Harris poll showed a drop in concert and performing-arts' attendance, but the figures were vigorously disputed by concert and performing-arts' associations.<sup>5</sup>

Another problem with the "present behavior" approach is that people's communication behavior is sometimes more indicative of their options than of their preferences. In the case of television programming, one scholar claims: "Scheduling factors . . . appear to confound any observed relationship between preferences and viewership."<sup>6</sup> Widespread participation may not mean people are completely satisfied with a system or service. Conversely, low use of a system or service may reflect its shortcomings rather than a lack of need for it. If only a small percentage of the population uses libraries, is there little need for libraries or is there a great need for better libraries?<sup>7</sup>

The pitfalls of forecasting needs by projecting from present behavior are perhaps clearest in hindsight. As Russell Neuman points out:

If we had tried to estimate the market demand for photocopiers 25 years ago based on the total market for carbon paper, we would have been off by several orders of magnitude.<sup>8</sup>

Small differences in quality, e.g., in ease of use, can translate into large differences in degree of use.<sup>9</sup>

Finally, the behavior-measurement method falls short in light of the widely accepted assumption that people will increasingly do things via communica-

<sup>2</sup>As Elaine Albright, a librarian at the University Of Maine, explains: "It [forces] us to have a dialogue that we never had before, to see why certain things really aren't being used." Personal communication, Oct. 1, 1987.

<sup>3</sup>"Nielsen Ratings May Be Axed by Networks," *The Washington Post*, Jan. 18, 1987, p. H1.

<sup>4</sup>Christine D. Urban, "The Competitive Advantage of New Publishing Formats," *Electronic Publishing Plus* (White Plains, NY: The Washington Program of the Annenberg School of Communications and Knowledge Industry Publications, 1985).

"Poll Finds Arts Attendance Has Declined," *The New York Times*, Mar. 16, 1988, p. C19.

<sup>6</sup>Carrie Heeter, "Cable and Program Choice," Dolf Zillmann and Jennings Bryant (eds.), *Selective Exposure to Communication* (Hillsdale, NJ: Lawrence Erlbaum Associates, 1985), p. 204.

<sup>7</sup>For low use of libraries by the general public, see Ching-chih Chen and Peter Herson, *Information Seeking: Assessing and Anticipating User Needs* (New York, NY: Neal-Schuman Publishing Co., 1982); and Brenda Dervin, "Communication Gaps and Inequities: Moving Toward a Reconceptualization," Brenda Dervin and Mel Voigt, *Progress in Communication Sciences* (Norwood, NJ: Ablex Publishers, Inc., 1980, vol. 2), pp. 73-112. Another potential telecommunication benefit that raises this question is that of "online" provision of health information. The Consumer Federation of America, in comments to Federal Judge Harold Greene, noted that elderly and low-income individuals are much less likely than the rest of the population to consult with health care service providers over the phone, and the elderly are less likely to use health information lines. (Response of the Consumer Federation of America, United Church of Christ Office of Communication, and the United States Public Interest Research Group to Comments on the Report and Recommendations of the United States Concerning the Line of Business Restrictions Imposed on the Bell Operating Companies by the Modification of Final Judgment, Mar. 13, 1987, p. 12). But does that mean that they would not use an 'online' health information resource?

<sup>8</sup>W. Russell Neuman, *The Media Habit* (White Plains, NY: Electronic Publishing Plus, The Washington Program of the Annenberg School of Communications and Knowledge Industry Publications, 1985), p. 9. This is true even when the projection is near-term. Neuman points out, for example, that media executives often fail miserably at predicting demand for programming for today's technology—the majority of movies and TV shows simply flop. *Ibid.*, p. 6.

<sup>9</sup>See, for example, Gary Stix, "What Zapped the Electronic Newspaper?" *Columbia Journalism Review*, vol. XXVI, No. 1, May/June 1987.

tion systems that they currently do in person, or that they currently don't do at all. If new capabilities encourage applications that have previously been impractical, it is difficult to imagine what those new applications might be simply by focusing on traditional applications.

For a summary of individuals' use of communication systems, including traditional, well-entrenched, and emerging systems, see box 8-A.

### **Approach 2:**

#### **Asking People What They Want and Why**

Another approach to needs' analysis is to ask people, through surveys, polls, and focus groups, what communication capabilities they want, or what they think of a hypothetical communication capability. This approach assumes that people can evaluate a communication capability before actually using it in a concrete, daily setting. With rapidly changing communication and information technologies, this may not always be possible.<sup>10</sup> For one thing, the immature prototype systems on which people often base their opinions are not always very representative of how the technology will evolve. And it can be very difficult to ask enough questions and present enough scenarios to illustrate the range of possibilities. Yet, accurate judgments about pricing, ease of use, convenience, and a host of other characteristics can be crucial in predicting usage.<sup>11</sup>

Notwithstanding these difficulties, it is tempting to try to infer from the data that are available. In the Harris poll on the arts, for example, 32 percent of those surveyed said there were not enough arts events and institutions in their areas.<sup>12</sup> Can it be inferred that they need more access to arts events via communication systems? Or would only in-person access alleviate this perceived deficiency?

In our marketplace-oriented society, needs are often defined by people's willingness to pay. However, it may be a mistake to equate "wants" with

"needs." People may not know, particularly in advance, "what's good for them." This argument is often made, for example, with respect to television.<sup>13</sup>

### **Approach 3:**

#### **Considering Social and Demographic Trends in Forecasting Future Needs**

A third approach to assessing needs is to identify social and demographic trends that influence how people communicate or how they might communicate in the future. It is universally agreed, for example, that the U.S. population is getting older. It is also widely believed that elderly persons frequently suffer from decreased mobility, loneliness, and the frustration of not being able to contribute to society as productively after retirement. Finally, some say that economic realities will force our society to find ways to keep the elderly participating in the work force longer. Taken together, these trends have led many to predict the need for communication systems that support increased involvement for the elderly.

There are many other social and demographic trends that one could identify, for the purpose of inferring communication needs. Some examples are:

- There are more women working outside the home. By 1986, nearly 52 million women were working, about 200 percent more than at the end of World War 2.<sup>14</sup> One inference that might be drawn from this trend, for example, is that there may be a greater demand for time-saving technologies, such as shop-at-home.
- There are more single-parent families. This trend might suggest the need for telework opportunities, as might the following trend.
- Traffic congestion and commuting times are increasing in many large metropolitan areas.<sup>15</sup>
- The number of non-English-speaking residents is rising, especially persons of Hispanic and

<sup>10</sup>In a recent National Regulatory Research Institute study of 1,000 business and 2,000 residential telephone subscribers in Ohio, less than 40 percent could name any new telephone service they would need in the next 5 years. *BOC Week*, Nov. 16, 1987.

<sup>11</sup>none 1985 survey, for example, found that although 44 percent of personal-computer users thought they would use their machines for "education," only 12 percent actually did; of the 19 percent who thought they would use them for "home budgeting/management," only 7 percent actually did. Evan Roth, "Power Surge in Personal Computers," *Editorial Research Reports*, vol. 1, No. 1, Jan. 9, 1987, p. 6.

<sup>12</sup>"Poll Finds Arts Attendance Has Declined," Op. Cit., footnote 5.

<sup>13</sup>See, for example, Robert MacNeil, "Is Television Shortening Our Attention Span?" *National Forum*, vol. LXVIII, No. 4, fall 1987, p. 21.

<sup>14</sup>David E. Bloom, "Women and Work," *American Demographics*, vol. 8, No. 9, September 1986, pp. 24-30.

<sup>15</sup>Robert Dunphy, "Urban Traffic Congestion: A National Crisis?" *Urban Land*, vol. 44, No. 10, 1985, pp. 2-7.

### **Box 8-A—Data on Technology Use**

*The* average person watched about 30 hours of TV per week in 1986. Women and elderly persons watched more, and there was little variation by household income.<sup>1</sup> The 1986 top 10 network programs were primarily entertainment-oriented shows: *The Bill Cosby Show*; *Family Ties*; *Cheers*; *Murder, She Wrote*; *Golden Girls*; *Night Court*; *60 Minutes*; *Growing Pains*; and *Moonlighting*. The top 10 syndicated programs were: *Wheel of Fortune*, *Jeopardy*, *PM Magazine*, the *New Newlywed Game*, *MASH*, *People's Court*, *Three's Company*, the *Oprah Winfrey Show*, *Southwest Conference Football*, and the *Phil Donohue Show*.

A 1983 study found that the average American spent about 11 hours per week on all forms of reading material. About one-half read books and spent an average of about 9 hours per week on them. Of these people, 40 percent read for "pleasure or recreation," and 27 percent for "general knowledge."<sup>2</sup>

Of the magazines we read, 21 percent are sports magazines (by number of titles, not circulation). Fourteen percent are general editorial, 6 percent travel, 5 percent crafts/hobbies, 4 percent each for music, literary, home/garden, art/antiques/amusements, 3 percent women's, 31 percent all others.<sup>3</sup>

Our household-originated mail consists primarily of bill payments (36 percent), greeting cards (21 percent), responses to ads (15 percent), letters to friends or relatives (11 percent), and invitations or announcements (4 percent).<sup>4</sup>

Most telephone calls are made for social reasons to the same handful of friends and family. One recent study found that the average household's five most frequently called numbers accounted for over two-thirds of all their calls. However, it is difficult to establish very precisely how people use the telephones.

The number of videocassettes households rent or buy rose from a median of 5.8 in 1984 to 22.6 in 1987 (during the same period, VCR penetration increased from 17 to 55 percent).<sup>5</sup>

Fifty-eight percent of Americans visit a library at least once a year, women more than men, and people with household incomes between \$20,000 and \$50,000 more than others.<sup>6</sup>

What are people using their computers for? A survey of members of the largest U.S. computer users group showed that 66 percent use their [home, not office] computers for word processing, 42.8 percent for entertainment, 33 percent for spreadsheet work, about 30 percent each for communications, programming, and database management, 28 percent for education, and 23 percent for budgeting.<sup>8</sup>

What are online computer conferencing networks being used for? One content analysis of an experimental system in California showed that 15 percent of all messages were "interpersonal" (mostly advice giving and seeking), 14 percent were "graffiti" (idle or obscene comments), 13 percent were "insults or alliance building," 10 percent were buy/sell advertisements, 5 percent social comment (mostly political), 4 percent "public service," 4 percent about the system itself, 3 percent about housing, 3 percent about music, 2 percent jokes, 2 percent event announcements, and the rest miscellaneous.<sup>9</sup> Other online systems cover a wide variety of subjects. The Whole Earth Electronic Link, for example, harbors conversations on movies, local and national politics, science fiction, the stock market, gardening, spirituality, business, and even the WELL itself.<sup>10</sup>

<sup>1</sup> "Television: 1987 Nielsen Report," The A.C. Nielsen Co.

<sup>2</sup> Joseph F. Brinley, Jr., "The 1983 Consumer Research Study on Reading and Book Purchasing," John Y. Cole (ed.), *Books In Our Future: Perspectives and Proposals* (Washington, DC: Library of Congress, 1987).

<sup>3</sup> IMS directory of publications, 1986.

<sup>4</sup> U.S. Postal Service Household Diary Study, November 1987, USPS Office of Rates.

<sup>5</sup> "Low-Income Households in the Post-Divestiture Era: A Study of Telephone SubscriberShip and Use in Michigan," study prepared by the Michigan Citizens Lobby for the Michigan Divestiture Research Fund, October 1986. See also B.D. Singer, *Social Functions of the Telephone* (Palo Alto, CA: R&E Associates, 1981); Martin Mayer, "The Telephone and the Uses of Time," Ithiel de Sola Pool (ed.), *Social Impact of the Telephone* (Cambridge, MA: The MIT Press, 1977).

<sup>6</sup> "Poll Finds Arts Attendance Has Declined," The New York Times, Mar. 16, 1988, p. C19.

<sup>7</sup> American Library Association, "Libraries in an Information Society: A Statistical Summary," June 1987.

<sup>8</sup> Boston Computer Society.

<sup>9</sup> Susan Douglas, "The Segmented Society: Can New Technologies Narrow the Gap," San Francisco State University, 1987.

<sup>10</sup> For more information see Mick Winter, *The Complete Guide to the WELL* (Yountville, CA: self-published, 1986).

Asian origins. This trend suggests the need, perhaps, for translating devices.<sup>16</sup>

Other trends are more derivative, and thus less reliable in assessing needs. They might include, for example:

- The complexity of life may be increasing, if gauged by the number and nature of the decisions that individuals face and the types of information they must assimilate to make decisions on matters such as health, for example. Such a trend might suggest a greater need for information access.
- A developing emphasis on self-improvement, which might foretell an increased demand for training and educational applications of communication and information technologies.
- A decline in overall free or leisure time, which would suggest the need for time-saving technological applications.<sup>17</sup>

#### **Approach 4:**

#### ***Trying To Identify Why People Use Existing Communication Systems***

Using more systematic and theoretical approaches, many researchers have sought to interpret the role of communication systems in people's lives. A sampling of these approaches follows.

Pioneered by Harold Lasswell in the 1940s, mass media theory identified four major functions of the media:

1. alerting individuals to shifts in their social, cultural, or political surroundings ("surveillance");
2. providing facts and analysis useful in decision-making or opinion formulation ("correlation");
3. facilitating escape ("entertainment"); and

4. providing a focus for social interaction and a means of obtaining information that can be used socially or to enhance status ("socialization").

*Uses and gratifications theory*, which emerged in the 1970s, claimed that media use is motivated both by "gratifications" (defined as "transitory mental or emotional responses that provide momentary satisfaction"), and by "uses" ("the anticipation of attaining pragmatic goals such as learning new behaviors, solving problems, making decisions, coping with environmental forces, reducing uncertainty, and strengthening predispositions").<sup>18</sup> This theory also acknowledges that media use is often "deficit-motivated"—that is, that people use media to relax, to relieve tension or fatigue, to kill time, to avoid boredom and loneliness, and to evade social conflict or psychological problems.<sup>19</sup>

*The theory of parasocial interaction*, introduced by Horton and Wohl in 1956, claims that mass-media users, particularly television-viewers, find friendship and intimacy in mass communication systems by developing "relationships" with persons in the media.<sup>20</sup>

*Interpersonal communication theory* holds that communication is crucial to the establishment, maintenance, and termination of human relationships, and to establishing and sustaining individuals' self-concepts.<sup>21</sup> Also cited as important functions are: informing and being informed, forming attitudes and beliefs, making decisions, attaining pleasure, assessing values, maintaining values, generating social change, and expressing ideas and innermost feelings.<sup>22</sup>

Each of the four approaches to identifying communication needs has its own strengths and weaknesses. These approaches, however, are not mutually exclusive, and each can contribute to the

<sup>16</sup>The number of Hispanics in the United States has grown by 30 percent since 1980, four times faster than the population as a whole. Joe Schwartz, "Hispanics in the Eighties," *American Demographics*, vol. 10, No. 1, January 1988, pp. 42-45.

<sup>17</sup>"Poll Finds Arts Attendance Has Declined," op. cit., footnote 5. See also John P. Robinson, "Trends in Americans' Use of Time: Some Preliminary 1975-1985 Comparisons," Survey Research Center, University of Maryland, College Park, MD, December 1986.

<sup>18</sup>Charles K. Atkin, "Informational Utility and Selective Exposure to Entertainment Media," Zillmann and Bryant, op. cit., footnote 6.

<sup>19</sup>For more on this approach, see E. Katz, J. Blumler, and M. Gurevitch, "Uses and Gratifications Research," *Public Opinion Quarterly*, vol. 37, 1973-74, pp. 509-523.

<sup>20</sup>Alan M. Rubin et al., "Loneliness, Parasocial Interaction, and Local Television News Viewing," *Human Communication Research*, winter 1985.

<sup>21</sup>See, for example, Donald P. Cushman and Dudley D. Cahn, Jr., *Communication in Interpersonal Relationships* (Albany, NY: State University of New York Press, 1985).

<sup>22</sup>Rebecca Rubin et al., "Interpersonal Uses of Communications," paper prepared for the annual meeting of the International Communications Association (ICA), Montreal, Canada, May 1987. See also C.C. Arnold and K.D. Fransen, "Conceptions of Rhetoric and Communication," C.C. Arnold and J.W. Bowers (eds.), *Handbook of Rhetorical and Communication Theory* (Boston, MA: Allyn and Bacon, 1984).

analysis in this chapter. To incorporate them all, however, it is necessary to stand back and focus not so much on communication needs per se, but on what people's needs are as individuals, and to ask how communication and the new communication technologies might best fill those needs.

## OPPORTUNITIES PROVIDED BY THE NEW COMMUNICATION TECHNOLOGIES

An approach that focuses on the needs of individuals assumes that human beings have a fundamental nature, a nature that can be observed and defined. This assumption is not new; it has formed the basis of both Eastern and Western religious thought, as well as political and social ideologies ranging from humanist philosophy to existentialist psychology.<sup>23</sup> There is some historical consensus, moreover, not only about the existence of human nature, but also on the subject of the human being's most basic needs. From Aristotle to Spinoza, Goethe, and Ibsen, poets and philosophers through the centuries have conceived of individuals as being compelled to search for the meaning of life through their individual endeavors to fulfill their potentials. This same perspective is repeated in art and literature.<sup>24</sup>

Psychologist Abraham Maslow also addressed the subject of human needs, which he viewed as being ordered in a particular hierarchy.<sup>25</sup> The basic survival needs, such as food and shelter, come first, followed in order of importance by needs for safety; belonging and relatedness; ego, relating to one's position within a group; and self-actualization, autonomy, and creativity. Individuals seek fulfillment of their higher-level needs only after they have satisfied their lower, more basic needs. The full

development of the individual, however, requires attention to those at the top of the hierarchy.

Communication and communication technologies are basic to all that an individual does. The following discussion of opportunities and constraints examines the uses of technology in a whole range of activities that, together, might contribute to the individual's meeting all of the basic needs as defined by Maslow. The activities examined include:

- education and self-improvement;
- counseling and psychological support;
- recreation and leisure, entertainment and self-expression;
- social interaction;
- economic participation;
- personal business;
- controlling and manipulating technology-mediated interactions; and
- overcoming barriers to physical mobility.

### *Education and Self-Improvement*

In a 1984 Gallup poll, 41 percent of the general public who responded ranked "encouraging lifelong learning" as the most important goal of the education system.<sup>26</sup> This response is not surprising, given that continuing education is prevalent in the United States today and is becoming more popular all the time. Overall, approximately 23 million people over the age of 17, or 13.5 percent of all adults, participated in some kind of part-time education in 1983, nearly double the number reported in 1957.<sup>27</sup>

New communication technologies could enable more individuals to take advantage of opportunities for convenient and effective education and self-improvement, both formal and informal. In the past, avenues for informal self-improvement—from

<sup>23</sup>Erich Fromm, *Beyond the Chains of Illusion: My Encounter with Marx and Freud* (New York, NY: Simon and Schuster, Inc., 1962). Writing on behalf of this notion, Erich Fromm notes, for example: "The question is by no means of a purely academic nature. If men differed in their basic psychic and mental structure, how could we speak of humanity in more than a psychological and anatomical sense? How could we understand the 'stranger' if he were fundamentally different from us? How could we understand the art of entirely different cultures, their myths, their drama, their sculpture, were it not for the fact that we all share the same human nature?"

<sup>24</sup>Characterizing human growth, the 20th century humanist psychologist, Karen Homey, writes: "The human individual, given a chance, tends to develop his particular human potentialities. He will develop then the unique alive force of his real self; the clarity and depth of his own feelings, thoughts, wishes, interests; the ability to tap his own resources; the strength of his will power; the special capacities or gifts he may have; the faculty to express himself; and to relate himself to others with his spontaneous feelings. All this will in time enable him to find his set of values and his aims in life. In short, he will grow, substantially undiverted towards self realization." Karen Homey, *Neurosis and Human Growth: The Struggle Towards Self Realization* (New York, NY: W.W. Norton, 1950), p. 17.

<sup>25</sup>Abraham Maslow, "A Theory of Motivation," *Psychological Bulletin*, vol. 50, July 1943, pp. 370-396.

<sup>26</sup>Phi Delta Kappa, *The Gallup Poll of Teachers' Attitudes Toward the Public Schools*, part 2, January 1985.

<sup>27</sup>U.S. Congress, Office of Technology Assessment, *Technology and the American Economic Transition: Choices for the Future*, OTA-TET-283 (Washington, DC: U.S. Government Printing Office, May 1988), p. 128.

“how-to” books to private lessons—have had very little to do with formal instruction through educational institutions. New technologies could potentially break down this barrier by making more of the institutional curricula available in a more appealing and attractive format for the home.<sup>28</sup> Recently, for example, “how-to” videotapes are proliferating on subjects ranging from golf and cooking to “How To Build a Gazebo” and “Teaching Your Parrot To Talk.”<sup>29</sup> Books-on-tape, convenient for filling niches of time (for example, while driving to work), are also very popular. The sale of nonmusical audio cassettes generated \$175 million in revenues in 1985.<sup>30</sup>

Meanwhile, schools and corporate training centers are experimenting with new audiovisual tools and formats—including live two-way audio and video remote-teaching systems—that, in many ways, resemble traditional home-entertainment media. The University of Maine, for example, is using fiber optics, satellites, and cable TV systems to provide interactive multimedia courses to underpopulated areas of the State, in some cases piping courses directly into individual homes. The Annenberg/Commission for Public Broadcasting project has funded several experiments on a new system that allows students at a remote classroom site to receive freeze-frame video or graphic images, superimposed with notations from an instructor’s pen, over normal telephone lines.<sup>31</sup> And several universities—including New York’s New School for Social Research, Purdue University, the New York Institute of Technology, and Nova University—offer online access to text-only courses for credit toward degrees or other credentials.<sup>32</sup>

Other efforts leave out the telecommunication component; one law school is using optical disk-

based interactive video programs to simulate courtroom situations.<sup>33</sup> Students, acting as lawyers, can participate (raising objections, for example) by typing instructions on a keyboard. The video then jumps to a point where the judge or opposing counsel responds to the particular objection. Such systems are also being used to let students perform simulated chemistry experiments, practice cardiopulmonary resuscitation, or learn how to weld metal seams.

Such experiments are precursors of the type of system that might provide home access to America’s educational infrastructure.<sup>34</sup> Much attention has already been focused on the potential of educational video. Video is being used to train and teach in a variety of settings. The Public Broadcasting Service’s National Narrowcast Service, for example, broadcasts educational programming via satellite and microwave systems to audiences at work sites and college campuses across the country.<sup>35</sup> Other groups are importing foreign programming via satellite for language and culture courses.

But critics note that unfulfilled promises of educational benefits have accompanied every wave of new technology, from the radio to the videodisk of the 1970s. And indeed, today’s systems face many obstacles. One commentator notes, for example, that although:

. . . the telecommunication technologies appear to have the potential to provide access to a wealth of intellectual resources . . . they are being developed in isolation from each other . . . We must find efficient ways to pass along to others both the learning materials that are being pioneered around the country and the teaching ideas that give them Power.<sup>36</sup>

<sup>28</sup>This curriculum has often been available through mail-order or extension courses, but in a less convenient or attractive form.

<sup>29</sup>Carol R. Riggs, “How-To Videos Are Growing Fast,” *D&B Reports*, September/October 1986.

<sup>30</sup>John Carey, “Telecommunications Technologies and Public Broadcasting 1986,” report prepared for the Corporation for Public Broadcasting, June 1986, p. 65.

<sup>31</sup>Lewning Math in the Space Age,” *The Boston Globe*, Mar. 1, 1987, p. 45. For a report on the use of new communication technologies for distance learning, see U.S. Congress, Office of Technology Assessment, *Linking for Learning A New Course for Education, OTA-SET-430* (Washington, DC: U.S. Government Printing Office, November 1989).

<sup>32</sup>0&. such courses are offered through intermediary institutions, such as the Electronic University Network, a division of San Francisco-based TeleLearning, Inc., “Turning Computers Into College Classrooms,” *Business Week*, Oct 14, 1985. See also Patricia Kirby, “Going to College Via the Computer,” *Capital Computer Digest*, June 1988.

<sup>33</sup>“Students Hone Skills in Video Courtroom,” *The New York Times*, Mar. 24, 1987.

<sup>34</sup>Some minimal level of access is already available. There are 30 thriving dial-a-grammar services nationwide, for example, mostly run by university writing centers.

<sup>35</sup>Mara Mayor and Peter J. Dirr, “Telelearning in Higher Education,” *National Forum*, vol. LSVI, No. 3, summer 1986, pp. 7-10.

<sup>36</sup>Ibid.

Others have expressed concern that telecommunication-mediated educational services might be used to justify the reduction of support for conventional education. They note that if this were to happen and educational materials were distributed via the marketplace, it could lead to great inequities in educational opportunities and attainment.<sup>37</sup>

### *Counseling and Psychological Support*

Closely related to the need for education and self-improvement is the need for counseling and psychological support in coping with life's problems. In today's environment of high divorce and crime rates, widespread substance abuse, and financial insecurity there is a need for both formal and informal support mechanisms.<sup>38</sup> One indicator of this need is the fact that, although participation in both traditional therapy and less-structured self-help groups is on the rise,<sup>39</sup> experts estimate that most mental health problems are going untreated, mainly because most people with such problems still do not seek professional help.<sup>40</sup>

Today, with the exception of telephone hotlines and book-based systems ("How to Lose Weight," for example), counseling is a face-to-face activity. However, new communication technologies could potentially make psychological support and counseling of many kinds more accessible to individuals, and help overcome the obstacles that typically prevent them from seeking help. In the nascent world of computer-conferencing, dozens of organized fora for sharing advice on general and specific problems have emerged, and experiments with more personalized services, incorporating traditional elements of therapy, are under way.

The online "support groups" were originally pioneered by handicapped and disabled people. Online groups are similar to face-to-face support groups, except that the discussions can be accessed from anywhere in the country, bringing together people with obscure problems who would otherwise never meet. And because they are ongoing, participate-at-your-own-convenience affairs, help is almost constantly available. As one person familiar with such groups noted:

A guy gets on [a computer conferencing system] and talks about his mother being sick and suddenly there are twelve other people there typing in their thoughts. It can be very supportive.<sup>41</sup>

There has been considerable discussion about using interactive electronic media to supplement or substitute for some types of traditional face-to-face therapies.<sup>42</sup> Such an approach, some claim, might cut down on the distractions of interpersonal proximity that have traditionally plagued therapy.<sup>43</sup>

Computer bulletin boards aimed at behavior modification have also been used experimentally, and in conjunction with traditional therapy, to help individuals set goals for themselves and monitor their progress toward achieving them. "The Health Connection," an online system headquartered in Houston, TX, enables participants to record information about their exercise, diet, and medication. The system then generates graphs showing indicators such as the number of calories consumed and expended. Participants can also send questions to experts online, and search a database of health information. Computers are also being widely used by professionals to administer and evaluate standardized diagnostic tests, such as the Minnesota Multiphasic Personality Inventory.

<sup>37</sup>"An '~ formation Age' for Everyone? Telecommunications and Information Services in California's Future," introductory paper for an informational hearing before the Assembly Committee on Utilities and Commerce, California Legislature, Sacramento, CA, Feb. 1, 1988.

<sup>38</sup>A recent study by the National Institute of Mental Health found that between 29 and 38 percent of adults have experienced a psychiatric "disorder." According to a 1983 Harris Poll, three out of five adults say they feel under great stress at least once a week. Problems with marriage or intimate relationships are the most frequent reason people seek help, followed by depression, relationships with co-workers, parents, or children; lack of self-esteem or feelings of insecurity; substance abuse; personality or character disorders, and sexual problems. See Martha F. Riche, "Behind the Boom in Mental Health Care," *American Demographics*, vol. 9, No. 11, pp. 34-37, 60-61, November 1987.

<sup>39</sup>From 16 to 25 percent of all visits to doctors' offices in the early 1980s were for psychological problems. An estimated 12 million Americans participate in roughly 500,000 self-help groups. Dan Hurley, "Getting Help From Helping," *Psychology Today*, January 1988.

<sup>40</sup>Riche, op. cit., footnote 38.

<sup>41</sup>Vic Sussman, "personal Tech: Let Your Fingers Do the Talking," *The Washington Post Magazine*, Oct. 19, 1986.

<sup>42</sup>For an overview, see Russ V. Reynolds, "Computer-Automated Service Delivery. A Primer," *The Behavior Therapist*, vol. 10, No. 5, 1987. The media under discussion are primarily computer-based, although at least one psychiatrist is already offering therapy via cellular telephone to Los Angeles motorists enraged at traffic tie-ups. "Car Phones Transforming U.S. Highways Into Moving Telephone Booths," *The New York Times*, Aug. 21, 1987.

<sup>43</sup>For example, some patients become physically attracted to the therapist; others attribute successes to the presence of the therapist, and then feel unable to achieve them without him/her.



Praising the benefits of online counseling, one researcher notes that changing behavior patterns is more easily accomplished if programs can be tailored to and scheduled into an individual's life. And computer programs are being designed to do just that.<sup>44</sup> Online systems also encourage participants to be more open in discussing their problems, and may allow the therapist to more easily obtain "confirming reports" and assistance from family and friends.

Other experts are less optimistic about the new technology. A number of them warn that technology may dehumanize the helping process. Others are concerned about the problems of quality control. At present, there are no official bodies that set standards or systematically evaluate the quality of therapeutic or self-help software.<sup>45</sup> In addition, issues involving medical confidentiality, malpractice, and liability for actions taken on the advice of online medical programs are still unresolved.

### *Recreation and Leisure, Entertainment and Self-Expression*

From movies to novels to rock-and-roll, "entertainment" has traditionally been one of the main driving forces in the development of American communication systems.<sup>46</sup> And so it continues today, judging from the time and money spent on it.<sup>47</sup>

Several trends relate to the future of leisure and communication media. First, as already noted, Americans have less and less leisure time,<sup>48</sup> putting a premium on home entertainment to eliminate travel.<sup>49</sup> Second, more entertainment options are becoming available via new technologies in the home, notably cable TV and videocassette recorders.<sup>50</sup> To the degree that most Americans enjoy spectator sports, theater, concerts, and other forms of art and entertainment, they are increasingly able to do so by means of the mass media.<sup>51</sup>

Mass-media entertainment, however, has traditionally been and continues to be primarily a passive activity. In contrast to participatory, communication-related, recreational activities, which have also been on the rise in recent years.<sup>52</sup> One of the promises of new communication systems is that they may offer a new meeting ground for traditionally separate active and passive activities—a way to combine entertainment and self-expression, and foster more active participation and creativity.

Self-expression and participation have always played a role in some mass media formats, from letters to the editor, to radio and TV talk shows, to game shows and shows like "People's Court," where the audience is encouraged to take sides and form an opinion.<sup>53</sup> And there is little doubt that people are interested in expressing themselves, judging from the deluge of artifacts like T-shirts, bumper stickers,

<sup>44</sup>Robert p. Hawkins et al., "Reaching Hard-To-Reach Populations: Interactive Computer Programs as Public Information Campaigns for Adolescents," *Journal of Communication*, vol. 37, No. 2, spring 1987, p. 11.

<sup>45</sup>Christopher Joyce, "This Machine Wants to Help You," *Psychology Today*, February 1988.

<sup>46</sup>Daniel J. Czitrom, *Media and the American Mind: From Morse to McLuhan* (Chapel Hill, NC: University of North Carolina Press, 1982).

<sup>47</sup>Not everybody has a telephone, but almost every single household has a TV and a radio. Watching television, experts agree, is the most popular leisure pursuit, followed in descending order by visiting or socializing, playing cards or other games, attending movies, making home or car repairs, gardening, exercising, attending sports events, visiting amusement parks, and attending arts events. John Robinson, "The Arts in America," *American Demographics*, vol. 9, No. 9, September 1987, p. 44.

<sup>48</sup>Robinson, op. cit., footnote 17.

<sup>49</sup>Office of Technology Assessment, op. Cit., footnote 27, p. 139. And a migration to more home-based entertainment is evidenced by industry statistics. By 1986, movie industry revenues from videocassette sales equaled revenues from box-office movie sales. See also "Studios Woo Cassette Mass Market," *The New York Times*, Feb. 27, 1986, p. C26; and "Poll Finds Arts Attendance Has Declined," op. cit., footnote 5.

<sup>50</sup>Other formats have emerged (such as compact disc audio) or may be emerging (such as direct broadcast satellite).

<sup>51</sup>Most broadcast events have higher media audiences than in-person audiences. One study showed, for example, that while only 13 percent of the population attended a classical music concertina given year, 20 percent listened to classical music on the radio, and 24 percent watched a classical music performance on television. Robinson, op. cit., footnote 47. See also Jeremy Schlosberg, "Who Watches Television Sports?" *American Demographics*, vol. 9, No. 2, February 1987, pp. 45-49, 59. For an example of the recent diversity available in entertainment programming, see "Fish Are Jumping on Many TV Screens and the Corn Is High," *The Wall Street Journal*, June 25, 1987.

<sup>52</sup>The number of painters, authors, and dancers rose at least 80 percent in the past decade; and between 1975 and 1980, the proportion of Americans involved in amateur photography rose from 19 to 44 percent, and of those who play a musical instrument from 18 to 30 percent. Robinson, op. cit., footnote 47; and James Ogilvy, "The Experience Industry," *American Demographics*, vol. 8, No. 12, December 1986, pp. 26-29, 59.

<sup>53</sup>For some audience members, the perceived line between reality and make-believe in this genre is thin: real small-claims courts are packed with people citing precedents from the television show, "People's Court." Michael Pollan, "Reality Shows: The Syndicated Bench," *Channels*, vol. 7, No. 7, July/August 1987, pp. 52-54.

coffee mugs, and posters that help people communicate their personalities to the world.<sup>54</sup>

Lately, other forms of pseudo-participation have emerged. There are hotlines that allow people to vote on the fate of their favorite TV characters,<sup>55</sup> and novelty-shop services where individuals can add their personality to a mass-media product by recording their own voice over the instrumental track of a top-40 hit.<sup>56</sup> Another recent phenomenon is the emergence of millions of home-based audio “broadcast” stations, in the form of telephone-answering machines. Several types of technology are emerging, or are being developed, that may strengthen the trend toward participation in entertainment.

Information production tools, for example, are making many forms of self-expression cheaper, easier, and more impressive, shifting the emphasis—as some put it—from perspiration to inspiration. Desktop publishing and design software, for example, enable individuals to produce professional-quality documents, layouts, and all manner of designs. Computers linked to synthesizers are giving amateurs studio-quality capabilities for creating and performing music, and, incidentally, for working collaboratively by trading musical “patches” (digitized musical excerpts) over telephone lines and via computer bulletin boards.<sup>57</sup>

Optical disks, together with authoring software, might further empower the would-be recreator/creator. According to one researcher:

Future videodisk novels will provide scenes of historic crisis, fantasy castles, or exotic modern locales that the “readers” will people, both visually and imaginatively, with characters of their own choosing.<sup>58</sup>

Such a description may call to mind the video game of the late 1970s, viewed by many as a fad but now making a comeback.<sup>59</sup>

Whether people will take advantage of such new opportunities is uncertain. Although video cameras and tape recorders have been widely available for some time, they have not sparked a new grassroots media genre. This lack of interest may reflect, in part, the dearth of distribution mechanisms available to the individual, as well as a lack of interest in programming not packaged with Hollywood’s gloss and slickness. It may also be a sign of limited talent or expertise. As one commentator says of desktop publishing:

If you don’t know what you’re doing, you’re just going to produce ugly documents faster.<sup>60</sup>

There are, however, notable exceptions. High school and college students across the country are producing video yearbooks. People with access to public cable TV studios are producing a hodgepodge of programs. In New York City, for example, one lady does a weekly singing tribute to Frank Sinatra, and a dentist answers callers’ questions about dental work. Talented individuals on shoestring budgets occasionally produce low-gloss, homespun films that succeed because their concept is good,<sup>61</sup>

The evolution of systems for self-expression and participation will also depend on the willingness of traditional information providers to provide raw material on an unbundled basis for repackaging by individuals. It has been said that the second best sports magazine in the United States would be a compilation of the cuttings in the editor’s wastebas-

<sup>54</sup>John W. Heeren, “Phrases on Your T-Shirt: Personal Graffiti in Modern Society,” *California Sociologist*, winter 1980.

<sup>55</sup>When Victoria principal announced she was quitting the TV show, “Dallas,” for example, *USA Today* set up telephone lines so people could vote on how the show should cleave with the loss of her character, Pam.

<sup>56</sup>Other popular items are custom-made sports cassettes, baseball cards, and magazine covers, where the customer is the star who hits the home run in the ninth inning or whose face appears on the card or cover.

<sup>57</sup>Between 1983 and 1986, sales of synthesizers soared more than fivefold to 350,000, while sales of brass-band instruments fell about 15 percent to 139,500. “Music Amateurs Find New Inspiration Composing at the Keyboard of Computers,” *The Wall Street Journal*, Oct. 29, 1987, p. 29. For more information about Musical Instrument Digital Interface (MIDI), see Michael Boom, *Music Through MIDI* (Redmond, WA: Microsoft Press, 1987), and Craig Anderton, *MIDI for Musicians* (New York, NY: Amoco Publications, 1986).

<sup>58</sup>Charles A. Goodrum and Helen Dalrymple, “The Computer and the Book,” John Y. Cole (ed.), *Books in Our Future: perspectives and Proposals* (Washington, DC: Library of Congress, 1987), p. 176.

<sup>59</sup>In 1981, video game arcade users spent \$5 billion—equal to the combined revenues of the Las Vegas gambling industry and the U.S. film industry, or the total television revenues and gate receipts of major league baseball, football, and basketball. Ronald Rice, “New Media Technology: Growth and Integration,” Rice and Associates, *The New Media Communication, Research, and Technology* (Beverly Hills, CA: Sage Publications, 1984).

<sup>60</sup>“Computers Let a Thousand Publishers Bloom,” *The New York Times*, Sept. 8, 1987, p. A1.

<sup>61</sup>For example, the movies “She’s Gotta Have It,” financed with the producer’s credit cards, and “Sherman’s March,” shot by one man with his videocamera. Also note the popularity of rock songs redubbed with spoof lyrics—a format pioneered by “Weird Al” Yankovic.

ket at *Sports Illustrated*. But what company will sell its material for such purposes? Will individuals have access to the vast archives of sounds, images, and text as raw material for repackaging? Certainly not without raising a host of intellectual property issues.<sup>62</sup> Moreover, without intermediaries to provide a modicum of quality control, some issues may also arise with respect to content, as in the case of Dial-a-Porn.

### Social Interaction

People use communication systems to build and maintain their “networks” of relationships.<sup>63</sup> These relationships are crucial both in satisfying specific needs, such as information-seeking,<sup>64</sup> and in sustaining a general sense of well-being.<sup>65</sup>

Innovations in communication have influenced patterns and characteristics of social interaction, whether among friends and relatives, or strangers. Pool notes, for example, that the telephone reduced loneliness, strengthened family ties, produced discontinuous communities, and generally stimulated social interaction.<sup>66</sup>

The past few years have seen the widespread adoption of telephone-answering machines, making interpersonal communication more convenient, and a drop in long-distance telephone rates, making such communication more practical for more individuals. A whole wave of electronic technologies is poised to revolutionize interpersonal interaction, potentially making such contacts more varied in format, more convenient, more random, more purposeful, or—depending on one’s perspective—more impersonal and unsatisfying. The new technologies can be divided into two categories: messaging systems such as facsimile, electronic (text-only) mail, and voice mail; and conferencing systems, which, like confer-

ence calls, enable two or more people to communicate interactively at the same time.<sup>67</sup>

The promise of electronic-conferencing systems is that they will encourage new types of social interactions among people who share common interests and among people at random. These systems create new types of situations in which people can meet, broaden the geographic scope of their potential interactions, and take some of the element of coincidence out of meeting people with specific interests. One example of such a technology already in widespread use is audioconferencing, also known as group bridging.<sup>68</sup> These systems allow people to participate in a conference call with a handful of complete strangers. Already active in several cities, these services are developing special lines for specific interest groups such as trivia buffs, soap-opera addicts, rock fans, and born-again Christians. One party-line in Boston even caters to men and women in the midst of divorce proceedings.<sup>69</sup>

One attraction of this type of system is the random contact with strangers it provides—an electronic sort of hitchhiking from the safety of one’s telephone. As Robert Kraut, a social psychologist at Bell Communications Research, says:

It is not that different from the anonymity you find on bus rides or plane rides. There’s someone you know you can spill your guts to without repercussions.<sup>70</sup>

In contrast, another new electronic meeting-place, the computer conference, better facilitates purposeful contacts. Much has been written about the stereotypical “hackers” who live, breathe, and hold their wedding ceremonies on these systems.<sup>71</sup> Behind this stereotype is a vast and growing universe of conferencing networks—corporate and nonprofit,

<sup>62</sup>For a discussion, see U.S. Congress, Office of Technology Assessment, *Intellectual Property Rights in an Age of Electronics and Information*, OTA-CIT-302 (Springfield, VA: National Technical Information Service, April 1986).

<sup>63</sup>Cushman and Cahn, op. cit., footnote 21, p. 1.

<sup>64</sup>Russell Neuman notes that more people rely on personal friends than organized or institutional sources for important information. Neuman, Op. Cit., footnote 8, p. 8.

<sup>65</sup>Cushman and Cahn, op. cit., footnote 21, p. @.

<sup>66</sup>Ithiel de Sola Pool, *Forecasting the Telephone A Retrospective Technology Assessment* (Norwood, NJ: Ablex, 1983), pp. 129-131.

<sup>67</sup>The line between these two categories is blurry, however, because some systems combine elements of the two by enabling people to participate in a conference by leaving messages that everyone else can see, regardless of when they “check in.”

<sup>68</sup>Ken Franckling, *UPI* (Lifestyle), dispatch on group bridging services, Sept. 22, 1987.

@Jack Seamonds, “The Newest Dating Game: Party Lines Are Humming and Also Controversial,” *U.S. News and World Report*, June 8, 1987.

<sup>70</sup>Franckling, op. cit., footnote 68.

<sup>71</sup>One researcher characterizes “the hacker” as “an addict who sleeps by day and works at a computer keyboard at night, feeding on junk food and the euphoria of computing.” Everett Rogers, *Communication Technology: The New Media in Society* (New York, NY: The Free Press, 1986), p. 235.

academic and commercial. It is estimated that there are between 7,000 to 10,000 private home-based bulletin boards in the United States today.<sup>72</sup> These online forums cater to every imaginable interest, from *botany* to arms control to dirty jokes. People with unusual interests can find their niche quickly, sometimes by searching the profiles of other participants to get specific details about them and their interests.

Some claim that electronic conferencing encourages freer communication because without visual and audio cues, such as appearance, tone of voice, and body language, people may be less embarrassed and therefore less inhibited. Says sociologist Sara Kiesler:

People focus their attention on the message rather than on each other.<sup>73</sup>

Theodore Roszak notes that electronic conferencing systems have “a liberating and leveling effect,” encouraging a certain amount of role-playing, because they “blank out race, age, gender, looks, timidity, and handicaps.”<sup>74</sup> He adds, however, that more anonymity can mean less accountability, leading to what he calls “nasty material: racist and sexist slurs, dirty jokes, profanity.”

While conferencing systems may change the nature of communication between strangers or acquaintances, new capabilities for keeping in touch could also affect closer relationships, in particular those among friends and relatives. The freeze-frame videophone, for example, one of the notorious unfulfilled promises of the 20th century (along with 3-D television and personal robots), shows signs of finally emerging as a popular and economical supplement to the telephone. Matshutsita, which recently began marketing a \$300 set that connects to a telephone line, had sold 64,000 of them by May 1988.<sup>75</sup> Although household demand for video

communication remains uncertain,<sup>76</sup> many organizations are already using videoconferencing; and as the technology gets cheaper, more are likely to do so.

New technology may also enable geographically dispersed individuals to share more experiences. Communication tools such as the television or the snapshot have often served as a setting or topic for social interaction. Future systems—those that allow people to share work or play games or learn together from a distance—could serve a similar purpose.<sup>77</sup>

Questions arise, however, regarding the hard-to-measure indirect and psychological effects of the new technologies. How effective, for example, is technology-mediated communication as a substitute for face-to-face interaction? Will improved communication capabilities accelerate geographic dispersal of families and friends? Or will they siphon off time spent in face-to-face interactions with nearby friends and neighbors? One indicative dilemma is the new phenomenon of “video visits” to nursing homes. Some have reported that showing videotapes of family members to elderly patients calms them and may make them feel “more involved.”<sup>78</sup> One Washington, DC, nursing home has initiated a “Visiting Through Video” program, funded by the Markle Foundation. The videos:

... have been particularly useful in helping staff cheer up residents who may be experiencing depression or having a difficult day . . . The staff benefits as well . . . By learning more about each resident's history and personality, they are able to provide individualized attention and deal more directly with specific problems and concerns.<sup>79</sup>

But some say video visits may also encourage relatives to postpone or avoid visits in person.

With respect to electronic conferences—whether audio, video, or textual-society may need to decide:

<sup>72</sup>*Whole Earth Review*, Winter 1987; also Steve Johnson, personal communication, May 12, 1988.

<sup>73</sup>Sara Kiesler, “Thinking Ahead: The Hidden Messages in Computer Networks,” *Harvard Business Review*, vol. 64, No. 1, January-February 1986, p. 48.

<sup>74</sup>Theodore Roszak, “Partners for Democracy: Public Libraries and Information Technology,” *Wilson Library Bulletin*, February 1986, p. 15.

<sup>75</sup>*Time* Magazine, Apr. 21, 1988.

<sup>76</sup>Only anecdotal evidence is available. One successful experiment, called the “Hole in Space,” set up cameras and TV screens at public locations in Los Angeles and New York so passers-by could see and talk to each other across the continent.

<sup>77</sup>Whether this will happen may depend on whether people perceive these systems as shared social, rather than individual, tools. Information-retrieval tools, for example, if equipped with large display screens that several people could view at one time, might be treated as a fun “game.” Most contemporary computer-related technologies (not to mention radio walkmen) have the reverse image: that of a personal shell to withdraw into.

<sup>78</sup>“Video Visits Help Elderly and Kin,” *The New York Times*, Feb. 25, 1987

<sup>79</sup>Barbie White, “Video Visits Help Families Say ‘I Love You,’” *Media & Values*, No. 45, winter 1989, p. 20.

- who will be admitted to them, and at what level of participation;
- what types of conferences can be kept private;
- whether content will be regulated—that is, will some types of electronic interactions require a monitor—and whether there will be well-defined rights, roles, and limitations for participants;<sup>80</sup> and
- whether people will be able to conceal their true identity or pretend they are someone else.

### *Economic Participation*

Technological change has historically brought about changes in the ways individuals participate in economic life. In preindustrial times, for example, the family served as the basic economic unit with most people working on a number of tasks, cooperatively, in their homes.<sup>81</sup> Industrialization gave rise to the factory system in which workers were organized to perform ever more routinized and specialized forms of labor.<sup>82</sup> Today, as discussed in chapter 5, new technologies once again create opportunities for changing economic relationships.<sup>83</sup> And, as in the preindustrial era, technology will now allow individuals to more easily work on their own schedules, at their own paces, in their homes. This technical capability, moreover, has come about at a time when, for a variety of reasons, self-employment, moonlighting (multiple job-holding), and part-time work are on the rise and at their highest levels in many years.<sup>84</sup>

One way in which new technologies have created economic opportunities is by lowering the barriers for individual endeavors. One such barrier, for example, is access to markets for professional services. New capabilities such as facsimile transmission, overnight mail, and electronic messaging

are enabling knowledge-workers such as writers, programmers, designers, and accountants to do much more freelancing, consulting, and part-time work. Consider freelance photographers, for example. In the past several years, taking advantage of these technologies, services have emerged that, for a fee, inform photographers across the country of editors' photographic needs. One person who runs such a service describes the implications for freelancers this way:

Before, if you were right next to the flagpole, you got the job. Today, if you're in Colorado and you see a request for a picture of a wildflower with a little bit of snow around it, you can get the job.<sup>85</sup>

Future communication systems could go even further in helping individuals advertise, sell, and deliver their intellectual products. One researcher has noted that France's Minitel:

... seems to make it possible for anyone, with next to no capital, not only to publish . . . but also to capture revenues, all in a single, integrated system.<sup>86</sup>

Technologies for coordinating work activities and enabling more flexible schedules may have a similar impact on the nature of economic participation. Telephone-answering machines, for example, have made it easier for freelancers to hold a daytime job and also keep in touch with customers. More recently, the advent of call-forwarding has made it substantially easier to hire an answering service.

Finally, the increasing capabilities and falling prices of information tools, particularly computers, have stimulated entrepreneurial participation in many industries. This trend is likely to continue. For example, a hot-air ballooning enthusiast in Sacramento, CA, who began publishing his monthly magazine, "Balloon Life" (circulation 2,500), when

<sup>80</sup>Audioconferencing services typically provide a monitor who is responsible for keeping the conversation going and warning about "inappropriate" language. In some areas, audioconferencing systems got off to a rocky start due to criticisms that they were being used for drug deals and for arranging trysts, in addition to the fact that children were running up huge bills without their parents' knowledge. Franckling, op. cit., footnote 68.

<sup>81</sup>Neil J. Smelser, *Social Change in the Industrial Revolution: An Application of Theory to the Lancashire Cotton Industry, 1770-1840* (London: Routledge & Kegan Paul, 1959).

<sup>82</sup>Shoshana Zuboff, *In the Age of the Smart Machine* (New York, NY: Basic Books, 1988).

<sup>83</sup>Michael Piore and Charles Sabel, *The Second Industrial Divide* (New York, NY: Basic Books, Inc., 1984). See also *ibid.*

<sup>84</sup>Of the approximately 700,000 new companies formed in 1985 (compared to 90,000 in 1950), 300,000 consisted of self-employed individuals. Roger Thompson, "Small Business," *Editorial Research Reports*, vol. 1, No. 23, June 19, 1987, p. 305. There are approximately 6 million "moonlighters," working an average of 14 extra hours per week. Richard Worsnop, "Part-Time Work," *Editorial Research Reports*, vol. 1, No. 22, June 12, 1987, p. 294. And there were about 19.5 million part-time workers in 1987, up from 12 million in 1970, according to the Department of Labor's Bureau of Labor Statistics, as cited in *The Washington Post*, Feb. 11, 1988, p. A18. About 3 million of these were "professionals," with the biggest gains in the ranks of part-time editors, library workers, and accountants. Worsnop, op. cit., footnote 84.

<sup>85</sup>Rohn Engh, personal communication, Apr. 14, 1988.

<sup>86</sup>Michael Rice (ed.), "Toward Enhancing the Social Benefits of Electronic Publishing," report of an Aspen Institute Planning Meeting, 1987.

desktop publishing equipment became available, explains:

The market is so small, the overhead had to be small to make it a viable product.<sup>87</sup>

Further reductions in the cost of distribution, perhaps via telecommunication, could make such efforts even more viable.

New technologies have also been regarded as the means by which businesses could provide flexible work arrangements, allowing people to perform their jobs at home. Such arrangements, it is argued, will not only increase worker productivity, but will also provide opportunities for people who, because of family responsibilities or physical disabilities, might be unable to work in an office situation.<sup>88</sup> In fact, recent experience with telework has proved that it is relatively successful in both regards.<sup>89</sup> However, it also shows that the technology, in and of itself, will not alter the nature of the work experience. On the contrary, the most successful cases of telework were those in which the traditional organizational principles of the office could be most easily transferred to the home.<sup>90</sup> As Margrethe Olson has noted, for telework to have a major, structural impact on work at home, the office itself will need to be integrated, and the technology will have to go further in assuring that:

- . computing power is inexpensive and portable;
- . there is access to all information resources required to perform the work in a form that is

accessible by computer, requiring that it be both “machine-readable” and “online;” and  
 . there is access to other people in the organization through communication networks that link all locations, office and home.<sup>91</sup>

New communication technologies will affect individuals’ economic lives not only as entrepreneurs and workers, but also as consumers. The increasing number of video transmission channels, for example, allows consumers to browse through a variety of live or taped home-shopping television programming services, and it will not be long before many people can routinely use their VCRs to examine products exhibited on full-motion catalogs, or videologs.<sup>92</sup>

More important to the consumer than browsing is the capability for comparative shopping that videotex services afford.<sup>93</sup> The systems now being used employ a tree-branch menu architecture-requiring a user to perform the motions of entering a store, selecting a department, and choosing a product. New information technologies, however, can engineer quick searches for all listings of a particular product in an entire catalog/mall, allowing consumers to compare and sort the relevant lists according to their own particular criteria. This opportunity could be extended even further, so that single catalogs are created to include listings of all products available from anywhere in the Nation, or even the world, in a particular product area. One might even envision many of the current specialized magazine publishers creating affiliated catalogs. This network market

<sup>87</sup>*The New York Times*, Oct. 8, 1987.

<sup>88</sup>At one time it was argued that as many as 50 percent of all office jobs could be performed in the home. See, for example, R.C. Harkness, “Technology Assessment of Telecommunications-Transportation Interactions,” Stanford Research Institute, Menlo Park, CA, 1977.

<sup>89</sup>For a discussion of recent experience with telework options, see Robert E. Kraut, “Predicting the Use of Technology: The Case of Telework,” Robert E. Kraut (ed.), *Technology and the Transformation of White-Collar Work* (Hillsdale, NJ: Lawrence Erlbaum Associates, Inc., 1987), pp. 113-133; and Margrethe H. Olson, “Telework: Practical Experience and Future Prospects,” *ibid.*, pp. 135-152. See also Jack M. Nines, “Traffic Reduction by Telecommuting: A Status Review and Selected Bibliography,” *Transportation Research*, vol. 22A, No. 4, 1988, pp. 301-317.

<sup>90</sup>Generally speaking, the successful cases were those involving people who either occupied upper-level positions and who traditionally managed their own time, or who were in low-level positions and their work performance could be easily monitored on the basis of output. Kraut, *op. cit.*, footnote 89; Olson, *op. cit.*, footnote 89.

<sup>91</sup>*Ibid.*

<sup>92</sup>“Re-ilers Page Through Videolog Possibilities,” *Advertising Age*, Jan. 18, 1988, special report on direct marketing, p. S13. In early 1988, two firms began pursuing shared use of a videolog, creating CD-ROM disks with up to 50,000 frames/pages of detailed catalog information. The catalogs, which include up to seven detailed photos of items from sellers equivalent in number to one mall, were made accessible to subscribers to the cable systems serving two small communities outside of Boston and Chicago. Both services permit users to instruct the central CD-ROM player to search and retrieve pages/frames by using the telephone. The still photos are distributed to homes via a cable television channel reserved for the service.

<sup>93</sup>Videotex is a general name for a “mass medium which delivers text and visual information directly to consumers. The user interacts with the system via a hand-held keypad, push-button console, or full alphanumeric keyboard. Desired information is retrieved interactively from a videotex center, through telephone lines, via cable, or over a regular television network, with text and graphics displayed on a television screen or other video monitor. While early systems involved terminals, increasing emphasis is being put upon accessing videotex systems with personal computers.” As defined by W. Wayne Talarzyk and Murray A. Young, “The New Electronic Media ‘Videotex,’” College of Business, The Ohio State University, RS 88-4, March 1988, p. 252.

concept can also be expanded beyond the realm of easily specified commodities to handle customized requests. For example, networks might be created that allow buyers to specify their needs—verbally or, more likely, in a written form on an electronic bulletin board—so that interested sellers could respond with bids in a kind of reverse auction.

Such systems could also improve buyers' access to evaluation services. The videotex service provided by Prodigy Services Co., for example, facilitates comparative shopping by providing easy access to *Consumer Reports*. As the use of such online catalogs increases, other evaluation services will probably be developed, ranging from those that rate items as acceptable or not to those that go into greater depth, evaluating different aspects of a product.

Notwithstanding these potential benefits, many experiments with videotex have failed, and most Americans remain unfamiliar with its concept.<sup>94</sup> However, this situation may be changing. In a recent survey on consumer awareness of videotex, one-half of the respondents expressed interest in videotex-type services. The results of this survey suggest that:

... videotex may be in a position similar to where television was following World War II. Some people have heard about it, a few had experienced it, but almost no one envisioned the impact it would have upon society over the next forty years.<sup>95</sup>

It should be noted that not all aspects of videotex are beneficial from the consumer's point of view. In participating in such systems, consumers make themselves available, in effect, to considerable intrusion on their private lives and increasingly sophisticated marketing devices. As pointed out in a U.S. Federal Trade Commission (FTC) report on videotex technology:

But the monitoring and control capability also raises substantial and difficult issues of individual privacy. And it places potentially enormous marketing power in the hands of vendors with access to personal or disaggregated information on viewing

and purchasing patterns. As a result, will marketers and advertisers be able to manipulate consumers more effectively knowing what their previous purchases have been?

Thus many of the new media, especially those that allow direct sales, raise troubling privacy issues. While some consumers may be willing to sacrifice privacy for the convenience of direct "electronic" ordering, the idea of a central data bank compiling viewing habits, purchasing behavior, and answers to opinion polls for every participating household raises the specter of Big Brother.<sup>96</sup>

By using videotex services consumers may benefit from reduced prices. However, they will also be assuming some of the work that was previously performed by marketers and retailers.

### *Personal Business*

*New* technology has typically, if not always accurately, been heralded as improving the quality of daily life by eliminating drudgery and enhancing the effectiveness of the individual's efforts. In an age of declining leisure time and increasing demands on that time due to the growing complexity of modern life, some claim that communication technology can make good on this promise by simplifying routine "personal business" activities such as shopping, scheduling, getting information, and personal finance management. Moreover, these technologies may enable people to feel more secure, confident, and in control, and to make better-informed decisions.

One potential the new communication technologies have is to allow individuals to make better use of their time. The videocassette recorder and the automated-teller machine have already introduced individuals to the benefits of "time-shifting"—doing something at one's convenience that would otherwise be impractical. Now a number of new technologies, such as call-waiting and electronic-messaging, are emerging to enable individuals to better juggle their activities.

<sup>94</sup>Ibid., p. 254.

<sup>95</sup>Ibid.

<sup>96</sup>U.S. Federal Trade Commission, *Report on the FTC Policy Review Session on New Media* (Washington, DC: U.S. Government Printing Office, 1979), p. 69, as cited in Vincent Mosco, *Pushbutton Fantasies: Critical Perspectives on Videotex and Information Technology* (Norwood, NJ: Ablex Publishing Corp., 1982), p. 104.

Portable systems such as pagers are also helping individuals to coordinate their activities.<sup>97</sup> Hospitals now dispense pagers so that prospective fathers and organ-donor recipients can be “on-call,” for example. And Sears, Roebuck’s dental care centers provide beepers to walk-in patients so they can browse until a dentist is available. There is a down side to these technologies, however, as anyone who has ever been paged by their boss late at night, or while on vacation, can attest.

We have already discussed how technology can match buyers with sellers. These same technologies may provide a host of other matching services that are useful to the individual. For example, online systems have been designed to facilitate ride-sharing by matching up riders with drivers. Some department stores have computerized their bridal registries so users can view a list of requested marriage gifts and determine which ones have already been purchased by others.<sup>98</sup>

Another time-consuming task that many individuals face is managing personal or family finances. A range of new technologies, from electronic home-banking to electronic-payment systems such as debit cards, promise to speed the completion of these tasks and give the individual more and timelier information about their financial situation. The Internal Revenue Service, for example, is field-testing online tax-filing systems to accompany computerized tax-preparation aids already available from tax-preparation firms or as stand-alone software packages.<sup>99</sup> Benefits to taxpayers could include quicker refunds and earlier warning of arithmetic or other errors.<sup>100</sup>

Another potential for enhancing personal efficiency may be realized by new systems that could improve access to a variety of information, from transportation directions and schedules to answers to questions concerning food preservation.<sup>101</sup> Already, toll-free and so-called “dial-it” [recorded information] telephone lines have revolutionized individual access to such “information on demand.”<sup>102</sup> A list of dial-it numbers available through New York Telephone, for example, includes horoscopes, horserace results, “technical sex tips,” Wall Street Reports, grammar tips, and many more topics. \*03

Another potential, if controversial, benefit of new communication technology is the security provided by devices that allow people to keep closer watch over one another. Some parents are reportedly giving their children pagers so they can check on them at any time. Elderly citizens already have access to a wide range of monitors and warning devices<sup>104</sup> that sound an alarm at a remote location should help be needed. Some claim these enable them to maintain a less risky independence in their own home. And although, as of 1987, only 3 percent of U.S. residences had monitored alarm systems to warn of fire, vandalism and burglary, and medical emergencies,<sup>105</sup> more effective technologies are emerging all the time.

Concerned that interpersonal relationships will come to be overly dependent on technological mediation, Jacques Ellul calls for a new ethic to deal with the use of technology:

This new ethic would also be an ethic of freedom. Powerful means do not necessarily insure freedom;

<sup>97</sup>By 1986, there were about 6 million pagers in operation. The most sophisticated were able to display up to 40 letters or numbers, scroll forward and backward, and store up to five messages. Doctors, the first to wear beepers, now represent only one-half of the users. Intercity paging networks have come online, and one can even buy rhinestone-studded beepers as Mother’s Day gifts. Peter W. Huber, Antitrust Division, U.S. Department of Justice, “The Geodesic Network: 1987 Report on Competition in the Telephone Industry,” January 1987.

<sup>98</sup>John Carey, “Terminals in Public Locations,” *Electronic Publishing Plus*, p. 18.

<sup>99</sup>Judy Rosenfeld, “The Electronic Taxman,” *PC World*, April 1987.

<sup>100</sup>Lest taxpayers get too enthusiastic, however, the IRS is also testing automatic dialer/recorded message players for calling to chastise delinquent taxpayers early on Saturday mornings.

<sup>101</sup>Which is not to say that traditional information sources like the newspaper will disappear, quickly or ever. As Huber notes: “A newspaper carries 30 million bits of information, weighs less than three pounds, handles both text and graphics, is completely portable, randomly accessible, 24 hours a day, costs less than 25 cents a connect-hour, and is mostly paid for by somebody else.” Huber, *op. cit.*, footnote 97, p. 22.

<sup>102</sup>Such lines have grown tremendously in recent years, but are not new. As early as the 1930’s, lines like dial-it existed for weather and time and were getting 20,000 and 60,000 calls a day, respectively. Pool, *op. cit.*, footnote 66, p. 121. See also “The Revolution Wrought By Toll-Free Calls,” *The New York Times*, Feb. 12, 1987.

<sup>103</sup>Huber, *op. cit.*, footnote 97, table PS.1.

<sup>104</sup>Not to mention emergency-care devices. Portable defibrillators can now send status information, such as a electrocardiograms, over telephone lines to a doctor in a hospital. The doctor can then decide if a shock is necessary, and instruct the onsite device to deliver it. “Reach Out and Defibrillate Someone,” *The Washington Post*, Health Section, Dec. 8, 1987, p. 5.

<sup>105</sup>Huber, *op. cit.*, footnote 97, p. 13.1.



on the contrary, technique has come to represent both necessity and fate for modern man, and thus, the effort to recover our ethical identity is the equivalent of resuming the fight for freedom. . . . In other words, we must decide that it is not technique that frees us but rather it is from technique that we must free ourselves.<sup>106</sup>

### *Controlling and Manipulating Technology-Mediated Interactions*

**New** technologies give some individuals more control over who they communicate with, when, and under what circumstances; at the same time, they deprive others of the ability to escape gracefully from unwanted communication or to benefit from anonymity in their communication. People have always taken advantage of their communication systems to exert control over their communication interactions. Some executives use secretaries to screen their calls, for example, and many people use telephone-answering machines for the same purpose. Tomorrow's communication systems will offer more opportunities for such screening and manipulation. By providing advance information about callers, new technologies, for example, allow people to program their telephone to screen out certain callers or to dispense different recorded messages to different callers.<sup>107</sup> Such capabilities will supposedly make communicating more convenient and efficient—for example, by helping to eliminate unwanted communication such as wrong numbers or crank calls. But they will also alter the psychological landscape of interpersonal communication, as have previous innovations.<sup>108</sup>

First, increased control and flexibility may invalidate traditional excuses for avoiding communication. With call-waiting, for example, keeping the line busy is no longer a viable avoidance strategy. In the near future, call-forwarding and portable devices like cellular telephones and laptop computers may make it physically possible for a person to be reached anywhere, anytime.<sup>109</sup> Such developments would make it increasingly difficult for individuals to distance themselves from the demands of others. <sup>110</sup>

Secondly, these capabilities may remove an element of anonymity, and thereby equality of opportunity, from communication. The ability to find out who is calling in advance, as Joshua Meyrowitz, author of *No Sense of Place*, explains, would “re-establish what the phone used to bypass,”<sup>111</sup> perhaps leading to a more formal communication environment where one would have to “present credentials” before being electronically admitted.

Part of the beauty [of electronically mediated communication] is the anonymity. The phone is an equal opportunity instrument.<sup>112</sup>

For some people, from resourceful reporters to job-hunters,<sup>113</sup> the loss of such anonymity might be a serious problem. One State American Civil Liberties Union (ACLU) director fears that people would stop reporting instances of crime and child abuse if they thought they might be identified.

Whether anonymity or “escapability” will actually be lost, or convenience gained, will depend on what future communication networks are allowed to do. For example, it is unclear whether service

<sup>106</sup>Jacques Ellul, “The Power of Technique and the Ethics of Non-Power,” Kathleen Woodward (ed.), *The Myths of Information: Technology and Postindustrial Culture* (Madison, WI: Coda Press, Inc., 1980), p. 246.

<sup>107</sup>Several regional telephone companies have already begun field-testing such services, which are known generically as “CLASS” (Custom Local Area Signaling Services).

<sup>108</sup>The telephone-answering machine, for example, allows people to “strategically call others when they know they are not home, so they can get credit for calling, but do not have to talk.” *The New York Times*, May 13, 1987, p. B1.

<sup>109</sup>Researchers are developing ways for people to “take their phone numbers with them,” perhaps by inserting a “smart” plastic card into the nearest telephone wherever they wish to be able to receive calls (in addition to the voice or text messages they may be able to receive wherever they are). Our culture has been anticipating this development for awhile—remember Maxwell Smart’s “shoe phone” on “Get Smart” and Dick Tracy’s watch-radio?

<sup>110</sup>Inescapability is not necessarily imposed by technology alone, however. Pool notes that the telephone’s ring is “an imperious command” that very few people today can ignore. Pool, op. cit., footnote 66, p. 142.

<sup>111</sup>Personal communication, Nov. 16, 1987.

<sup>112</sup>*Ibid.*

<sup>113</sup>Some job-hunters are already under pressure to provide more advance information in the form of “video resumes.” The tapes, which can cost up to \$300 to produce, are especially important for visually oriented (e.g., artistic) jobs, but are increasingly catching on in other fields. As one employer notes, (WSJ) the tapes are “a quick way of deciding whether [a candidate] met the basic requirements: appearance, command of the language and presentation abilities.” Colleges are also beginning to receive the tapes—on average, from 5 percent of their applicant pools. *The New York Times*, Jan 3, 1988.

providers would be allowed, or even able, to provide the name as well as the number of a caller.<sup>114</sup> Or whether there would be restrictions on subscribers' abilities to trace calls. Is the invasion of privacy an unwanted call, or is it the tracing of that call? And what about unlisted telephone numbers? Many people will not want their communication "address" revealed to others, or to selected types of others. A recent New Jersey field test of a prenotification service prompted complaints from the ACLU and individuals that it compromised the individual privacy of individuals with unlisted numbers.<sup>115</sup> The desire for invisibility may also be selective—a company might want its directory available to clients, for example, but not to headhunters.

Finally, etiquette will play a role in structuring the new communication environment. As technological capabilities change, so may society's perceptions of what is appropriate and acceptable in interactions.<sup>116</sup> We are entering a period of rapid change, with many new capabilities emerging simultaneously. Their design and presentation will likely have a significant impact on how they are used.

### ***Potential for Overcoming Barriers to Physical Mobility***

Many people are prevented from participating in society as fully as they would like because of serious barriers to physical mobility. These barriers can be biological—such as physical handicaps and advancing age—or situational, such as difficulty in finding adequate child care, traffic congestion, and lack of time. In an age characterized by impending labor shortages,<sup>117</sup> a growing population of elderly people who may face increasing pressure to continue contributing economically, and more women in the work force, communication technologies that facili-

tate fuller individual participation will be very important.

Technologies such as the VCR that allow an activity to be rescheduled to a more convenient time have come to be known as "time-shifting" technologies. Systems are emerging that could be called "space-shifting" technologies because they allow individuals to do things in a more convenient place. A videoconferencing system in Brooklyn, New York, for example, designed to streamline the arrest process, allows crime victims and witnesses at the 73rd Precinct station to converse "face-to-face" with prosecutors 5 miles away, in many cases making depositions possible where they otherwise wouldn't be.<sup>118</sup> In Whitman County, WA, a bookmobile equipped with a packet radio<sup>119</sup> offers mobile access to the central library's online card catalog. A cellular telephone hookup in Livonia, MI, allows mobile units to take onsite X-rays for instant analysis at a hospital miles away.<sup>120</sup>

Workers such as writers, data-entry clerks, and engineers are less and less tied to one work location because the technology allows them to transmit textual and graphical information over telephone lines. Even prisoners are using communication systems to participate in the outside world. Inmates of the Stillwater, MN, correctional facility are making telemarketing calls as part of a rehabilitation plan. And inmates of an Arizona women's prison have been taking 800-number telephone reservations for Best Western Hotels for nearly 9 years.<sup>121</sup>

Technologies under development may further sever ties to physical locations. Joint authoring, design, and editing technologies, for example, will make it easier to collaborate with someone who is far away.<sup>122</sup> New call-distribution systems will enable businesses to route overflow call traffic to home-based clerks at their home telephone numbers

<sup>114</sup>If the caller were a friend calling from an unfamiliar number, or a stranger calling from a familiar number, this would obviously not be possible.

<sup>115</sup>According to Survey Sampling, Inc., Fairfield, CT., one in four Americans has an unlisted telephone number, and unlisting has increased by 25 percent nationwide in the last 4 years. As cited in "Sorry, No Number," *The New York Times*, The Editorial Notebook, Dec. 14, 1988, p. A30.

<sup>116</sup>See Judith Martin, "The Telephone at Home," *Miss Manners' Guide to Excruciatingly Correct Behavior* (New York, NY: Warner Books, 1983), pp. 196-206.

<sup>117</sup>See Terry S. Supple, "The Coming Labor Shortage," *American Demographics*, vol. 8, No. 9, September 1986, pp. 32-35.

<sup>118</sup>"Picturetel Videoconferencing Systems Help Link police, Prosecutors and Crime Victims in Brooklyn, New York," *Telecom Highlights International*, vol. 8, No. 29, July 22, 1987, p. 13.

<sup>119</sup>Packet radio is a technology for transmitting data over the airwaves.

<sup>120</sup>Barbara Swaab, "Cellular Speeds X-Ray Diagnosis," *Cellular Business*, July 1986.

<sup>121</sup>"Prison Inmates in Telemarketing Sales," *D&B Reports*, November/December 1986.

<sup>122</sup>See "Proceedings of the First Conference on Computer Supported Cooperative Work," sponsored by the Association for Computing Machinery, 1987.

whenever the in-house clerks are busy.<sup>123</sup> And capabilities such as those provided by CD-ROM (compact disk-read only memory) optical disks that may substitute for the shared support resources of a central office (like libraries or reference materials) could further increase the geographical flexibility of some workers.

Space-shifting systems may enable certain groups—like the elderly—to participate in society longer and more fully than would otherwise be possible. After 2 years, the results of an online program at the University of San Francisco, called SeniorNet, indicate that:

SeniorNet members began to play more active roles in their communities. Learning computer skills opened up job possibilities for some and helped others relate with computer-using family members. . . [also] by giving them access to technological tools we have the opportunity to share their ideas, learn from their experiences and understand their wisdom.<sup>124</sup>

Space-shifting also benefits individuals suffering from serious health problems. For example, a recent report on corporate strategies for coping with AIDS promoted working at home—technology-assisted if possible—as a way of keeping AIDS victims on the job as long as they are able to work.<sup>125</sup>

But some argue that such systems may only increase feelings of isolation and frustration. Says Erik Sandberg-Diment:

Most people would probably miss the real world too much. Have you ever asked your computer, “What are you doing after work?”<sup>126</sup>

John Naisbitt, author of *Megatrends*, agrees:

The utilization of electronic cottages will be very limited: people want to go to the office; people want to be with people.<sup>127</sup>

Martin Elton wonders whether such arrangements might not in fact become “electronic ghettos,” and notes that the results might be mixed, particularly for the elderly.<sup>128</sup> These systems enable them to socialize and participate more without going out, he says, but perhaps the excuse to go out and be with people is what keeps them going.

## KEY FACTORS SHAPING IMPLICATIONS FOR THE INDIVIDUAL

How individuals use the new communication technologies and the impacts they have on their lives will depend on a number of factors. This chapter examines three of these:

1. technological literacy factors;
2. socioeconomic factors; and
3. factors relating to system design and support.

### *Technological Literacy Factors*

The issue of literacy has received much attention in recent years, with estimates of rampant illiteracy sparking controversy over the definition of the problem and the nature of possible solutions.<sup>129</sup> Increasingly, the literacy debate is being broadened to include discussions of new communication tools and the skills required to use them. This section will address this issue by focusing on the following questions:

- Do skill requirements constitute a barrier to individuals’ use of emerging communication systems?
- What characteristics of the new technologies influence the level of skills required to use them? and
- Should these skills be incorporated into a more general definition of literacy?

<sup>123</sup>Personal communication, Michael Gibbons, Vice President, Bell Communications Research, June 13, 1988.

<sup>124</sup>SeniorNet, an online program for seniors, was established in 1986 at the University of San Francisco, supported by the John and Mary Markle Foundation. For a discussion, see Mary Furlong, “On-Line Connection Makes Friends for Seniors,” *Media & Values*, No. 45, Winter 1989, p. 11. See also Greg Kearsley and Mary Furlong, *Computers for Kids Over Sixty* (San Diego, CA: Park Row Press, 1988).

<sup>125</sup>*The Wall Street Journal*, Jan. 20, 1988.

<sup>126</sup>Erik Sandberg-Diment, “Waving to the Future from the Electronic Cottage,” *The New York Times*, Jan. 21, 1986, p. 19.

<sup>127</sup>John Naisbitt, *Megatrends: Ten New Directions Transforming Our Lives* (New York, NY: Warner Books, Inc., 1982), p. 46.

<sup>128</sup>Martin Elton, “When Will the Information Explosion Reach Older Americans?” *American Behavioral Scientist*, vol. 31, No. 5, May/June 1988, pp. 564-575.

<sup>129</sup>Estimates of the number of illiterates have ranged from single-digit percentages to one-third of the population. For an overview of the debate, see Charles A. Goodrum and Helen Dalrymple, “Illiteracy in the U.S.,” Cole (ed.), op. cit., footnote 58, pp. 40-50.

Many experts, especially in the wake of the proliferation of personal computers, take the position that communication technologies are broadening the range of skills that should be considered necessary to be "literate." <sup>130</sup> Others claim that, as was the case with the automobile, the need for special expertise in using the new technologies will pass as the devices become more sophisticated. <sup>131</sup> Few dispute, however, that the current generation of communication technology is posing substantial challenges to individuals' learning abilities. From computers to programmable VCRs and answering-machines, to advanced-calling features, the frustrations of figuring out the often complex procedures are widely in evidence.

Corporations have been forced to spend millions of dollars, for example, to teach their employees how to use new private branch exchange (PBX) telephone systems. <sup>132</sup> User groups have sprung up across the country so people can help each other master the nitty-gritty details of computing. <sup>133</sup> As one scholar puts it:

The home computer is a rather complex product requiring special skills and possibly some training. <sup>134</sup>

Such complexities may discourage potential users. Many people, according to Casimir S. Skrzypczak, Vice-President at Nynex, find the new communication services "too difficult to either learn

in the first place or [to] remember." <sup>135</sup> Jakob Nielsen concurs:

Just the perception of the necessity of acquiring a huge amount of knowledge to get started keeps many people from trying new systems. <sup>136</sup>

Contributing to this phenomenon is the fact that people may be uncertain about the benefits of the technology in the first place. One Bell Communications Research study of residential users' adoption of new telephone services found that:

... in cases where it was clear to users how they could do it and what it would do for them, [the new services] were used. \*37

But otherwise they were not.

Even the people who do try out new communication technologies, however, frequently experience frustration. According to recent research, people tend to shy away from investing in the additional learning necessary to take full advantage of the new tools--exhibiting what some researchers call "satisficing" behavior. <sup>138</sup> The pull of familiarity is so strong, in fact, that many people:

... prefer to continue to use an older, less powerful software package that they have learned rather than face a new learning curve. <sup>139</sup>

Several hypotheses have been advanced to explain the difficulties individuals are having with emerging communication technologies. Although the research has focused primarily on the computer

<sup>130</sup>See, for example, Carolynn Van Dyke, "Taking 'Computer Literacy' Literally," *Communications of the ACM*, May 1987, vol. 30, No. 5, Pp. 366-374.

<sup>131</sup>The automobiles of the 1920s, for example, required a person to crank the starter handle and muddle through other technical details. The automobile analogy is often made in the computer industry. Lotus Development Corp. founder Mitchell Kapor, for example, says that most people "don't want to know how it [the computer] works. They want to get it in drive." *The Wall Street Journal*, "Computer Firms Step Up Efforts to Make Machines Easier to Use," Dec. 14, 1987, sec. 2, p. 1.

<sup>132</sup>"Modern Telephone End-User Illiteracy Problem Being Confronted," *Network World*, Nov. 17, 1986, p. 23.

<sup>133</sup>A recent *New York Times* article on poor productivity in the service industries quoted one analyst as saying: "Many managers and employees still lack the knowledge to use computers and electronic hardware effectively . . . there is a lot of experimentation . . . and a lot of horror stories." *The New York Times*, June 29, 1987.

<sup>134</sup>Nicholas P. Vitalari et al., "computing in the Home: Shifts in the Time Allocation patterns of Households," *Communications of the ACM*, May 1985, vol. 28, No. 5, p. 520.

<sup>135</sup>Casimir S. Skrzypczak, "The Intelligent Home of 2010," *IEEE Communications Magazine*, December 1987.

<sup>136</sup>Jakob Nielsen et al., "Integrated Software Usage in the Professional Work Environment," Proceedings of the 1986 Conference of the Computer-Human Interaction Special Interest Group of the ACM. Often this perception is reinforced by the size and grammatical obfuscation of the manuals that accompany many new communication tools.

<sup>137</sup>Michael A. Gibbons, Assistant Vice President, Bell Communications Research, personal communication, June 13, 1988. Call-waiting, according to one report, has grown twice as fast as any other custom-calling feature because access is completely automatic--customers do not press any buttons to use it. "The Telecom Strategy Letter," Northern Business Information, Inc., 1987.

<sup>138</sup>"Satisficing," a term coined in 1969 by H.R. Simon, is the "satisfying of critical requirements just sufficiently to handle the problem at hand without necessarily optimizing the solution." Nielsen, op. cit., footnote 136. In other words, this is getting by any way you can even when you know there must be a better way.

<sup>139</sup>Association of Data Processing Organizations, "Report on Computer Connectivity," March 1987, p. 15.

because it is programmable, multipurpose, and heterogeneous, the results are relevant to other technologies that may share these characteristics. Some researchers point to the fact that the new systems require more abstract and deductive reasoning than traditional tools such as copying machines or typewriters, which are amenable to simple rule-following.<sup>140</sup> One commentator has compared learning how to use a computer to taking up a musical instrument.<sup>141</sup> Others note that often individuals must modify computer-related tools to fit their particular needs and circumstances—for example, by customizing a word processor's printer driver file to a specific printer, or by designing a database to store specific information. This "reinvention" process, as Everett Rogers calls it, often entails "several weeks of frustrated problem-solving and information seeking after the initial purchase."<sup>142</sup> Still others point to the diversity of systems as an impediment to communication "literacy," claiming that the multiplicity and inconsistency of command schemes and other procedures confuse individuals and deprive them of synergies in acquiring expertise. Nicholas Vitalari, a professor at the University of California, Irvine, comments:

Industry cannot expect the average consumer to be fluent in person-machine interfaces of multiple systems. 143

It is uncertain whether technological advancements will alleviate the difficulties of operating communication systems, thereby decreasing the need for any special literacy.<sup>144</sup> Technology is

emerging to make systems easier to use and understand,<sup>145</sup> but these user-friendly helper programs may sacrifice functionality for simplicity. According to Tom Stewart, they can be "slow, lacking in power and rather rigid in the way they [can] be used."<sup>146</sup>

In the meantime, it is clear that skill requirements remain a barrier to individual use of communication tools. What is not clear is the relative importance of, and the distinctions between, different types of new communication skills. As one observer notes:

Few educators understand which [new technology] subjects fall into which category. . . [and] the general public is even in worse shape in guessing what skills they should learn. \*47

Recent definitions of literacy, in the traditional sense, perhaps offer a model for a definition of communication literacy in the emerging technological environment. These definitions have tended to identify a range of skills that comprise literacy, and different levels of those skills that contribute to different levels of literacy. One might be able to read a bus schedule, for example, but not be able to figure out when the next bus is coming. 148 Defining literacy requires determining which skills are necessary, and at what levels of proficiency. To this end, it is necessary to ask questions about specific technologies, while paying attention to their role in society. For example, if a library stops updating its paper card-catalog (as the Library of Congress did in 1986), should literacy include the ability to perform

<sup>140</sup>At The Women's Computer Literacy Project in San Francisco, computer skills are taught by explaining the whole system in everyday terms, using analogies that reduce **technical** terms to familiar concepts.

<sup>141</sup>Everett Rogers, *Communication Technology: The New Media in Society* (New York, NY: The Free press, 1986), p.116.

<sup>142</sup>Ibid.

<sup>143</sup>Nicholas p. Vitalari and Alladi Venkatesh, "In-Home Computing and Information Services," *Telecommunications Policy*, March 1987, p. 70.

<sup>144</sup>Among those who argue that it will be Roger Schank and Peter Childers, *The Cognitive Computer* (Reading, MA: Addison-Wesley, 1984).

<sup>145</sup>An example of such a technology is "Grateful Meal," a system that helps users formulate searches for the database of the National Library of Medicine. Progress is also being made on software to compensate for human inconsistencies in searching and navigating—the tendency to use different synonyms to refer to the same topic on different days, for example. G. W. Furnas, T.K. Landauer, L.M. Gomez, and S.T. Dumais, "The Vocabulary Problem in Human-System Communications," *Communications of the Association for Computing Machinery*, vol. 30, No. 11, November 1987, pp. 964-971.

<sup>146</sup>Tom Stewart, Editorial Opinion, *Behavior and Information Technology*, vol 6, No- 2, April/June 1987, p. 95.

<sup>147</sup>Rob Horn, (wanginst!infnet!rhorn on the USENET, a computer mail network). The general confusion over the importance of computer skills has been evidenced by the ephemeral boom of "computer camps." There were over 500 overnight camps offering computer training as an activity at the phenomenon' speak in the summer of 1984, and about 20 devoted exclusively to teaching computer skills. By 1987, there were fewer than 200 offering any training and only several full-time computer camps. Jim Lemonn, American Camping Association, personal communication, Dec. 10, 1987.

<sup>148</sup>A fairly interesting definition, relevant also because it is nontechnology-specific, is the one recently advanced by the National Assessment of Educational Progress: "using printed and written information to function in society, to achieve one's goals, and to develop one's knowledge and potential." Irwin S. Kirsch and Ann Jungeblat, "Literacy: Profiles of America's Young Adults," National Assessment of Educational Progress, Princeton, NJ, 1986, p. 3.

an online keyword search? <sup>149</sup> Will literacy in the year 2005 mean the ability to use a spreadsheet? To manage a hard disk? To hook up an old-style 1980s 1200-baud modem and get it running? <sup>150</sup>

Finally, some argue that regardless of the technological environment, literacy will still rest on basic abilities which, by many current accounts, are still severely lacking. According to two writers:

The information gap is not likely to be solved by easier-to-use interfaces, better ergonomic designs, or artificially intelligent programs. [These systems] require basic reading literacy, knowledge and certain cultural backgrounds, to be used effectively and employed beyond the level of simple entertainment. <sup>151</sup>

The question of promoting literacy in new communication technologies is inextricably intertwined with the question of socioeconomic factors and access to these technologies. But in a society where many will not be able to afford to buy technology for their homes, public-access facilities may be crucial to maintaining certain minimum levels of communication competence. When the telephone emerged in the early 1900s, one of the primary functions of public telephones was to allow people to learn to use them by watching others. <sup>152</sup> Other public-access facilities—from schools to libraries—have traditionally provided a repository for the expertise, in both print and human form, to help people communicate or get information.

A new vision of the public-access facility, to help individuals cope with the complexities of information-age tools, is perhaps in order. In recent years, there have been several noteworthy initiatives. “Hands-on” learning centers—part museum, part classroom, part recreation center—seem to be taking hold across the country. One example is “Playing to Win,” a New York City-based nonprofit center, located in the basement of a housing project building, where neighborhood residents can work with and learn about computers. On a larger scale, the Boston Computer Society is planning a \$3 million “Computer Discovery Center” to address people’s basic questions such as: “What can I do with a computer?” “What do I need to know about computers?” and to “help them feel in control of, rather than controlled by, technology.” <sup>153</sup>

### *Socioeconomic Factors*

*The* relationship between socioeconomic status and access to communication systems has traditionally been a matter of lively debate and a focus of policy efforts. The concept of universal service, for example, was developed when access to a telephone was deemed vital for an individual to function in society. <sup>154</sup> Since the 1970s, the debate over the link between socioeconomic status and “access” has intensified, with some claiming that there is an increasing stratification of society based on differential access to communication tools and information sources. <sup>155</sup> Others have questioned the validity of these claims, countering that many innovations such as computers and satellites are indirectly benefiting

<sup>149</sup>Or the ability to know when not to use an online system? According to Edmund Pellegrino, it is important for individuals to know “what information [they] want processed, what has been left out, when to ditch the program or the algorithm, and whereto go to read it for [themselves].” Edmund D. Pellegrino, “The Computer and the Book: The Perils of Coexistence,” Cole (ed.), op. cit., footnote 58, p. 86.

<sup>150</sup>Carolynn Van Dyke lists the general categories into which most academic researchers currently divide “computer literacy:” familiarity with computers and data processing (“awareness”); ability to use applications programs; ability to program; and knowledge of the ways in which computerized systems are integrated into the social order. These categories may soon begin to divide up into more categories, as authoring systems become available that will allow people to design and actually construct programs of varying sophistication without understanding the nitty-gritty of computer language semantics and structures. Van Dyke, op. cit., footnote 130, p. 367.

<sup>151</sup>Vitalari and Venkatesh, op. cit., footnote 143, p. 73.

<sup>152</sup>Carey, op. cit., footnote 13. It sounds silly now, but at the turn of the century, “telephone literacy” courses were offered commercially. Lloyd Morrisett, in Michael Rice (ed.), “Toward Harnessing New Electronic Technologies to Meet the Needs of Elderly People,” report of an Aspen Institute Planning Meeting, 1987.

<sup>153</sup>From the fund-raising literature of the Boston Computer Society. In Sweden, some villages have “tele-cottages” equipped with a variety of high technology equipment. These provide an information bank and training center; provide services to small businesses; create a network of competence; and create employment in rural areas. Funding comes from county government and municipal boards, and Swedish Telecom. “The Tele-Cottages in the Nordic Countries,” *Telecommunication Journal*, vol. 55, No. V, May 1988, pp. 307-310.

<sup>154</sup>Cross-subsidies and “lifeline” programs have been the chief weapons in the battle to get a telephone in every home, a battle that has not yet been completely won.

<sup>155</sup>These researchers speak of communication gaps between the “information rich” and the “information poor.” See, for example, Oscar Gandy, “The Political Economy of Communications Competence,” Vincent Mosco (ed.), *The Political Economy of Information* (Madison, WI: University of Wisconsin Press, 1987). See also Cecilie Gaziano, “The Knowledge Gap: An Analytical Review of Media Effects,” *Communication Research*, vol. 10, No. 4, October 1983.

the entire population,<sup>156</sup> and that other innovations will follow historical patterns and achieve widespread dissemination after initial adoption by an affluent minority.<sup>157</sup>

From either point of view, questions emerge. How strongly does income correlate with access to communication systems? How is this relationship changing with the emergence of new technologies? Are there classes of technology-empowered individuals, and might new technologies sharpen or blur the divisions between these classes? And, as Ben Compaine asks of the new tools and capabilities:

What are necessities, what are frills, and what falls in a debatable middle ground?<sup>158</sup>

There has traditionally been some link between communication behavior and socioeconomic status. People without telephone service, for example, have generally been poorer, younger, and less settled than the rest of the population.<sup>159</sup> And people from higher-income households read more books,<sup>160</sup> and could better afford magazines, long-distance calls, and transportation for face-to-face interaction. Nonetheless, the major systems of communication (television, radio, basic telephone service, newspapers, and the postal service) have achieved widespread penetration and use in most strata of society.

Recent technologies, however, have broken this pattern, running into what one observer calls "penetration Walls."<sup>161</sup> Although these products and services are expected to achieve greater penetration over time, income appears to be a strong factor limiting

this penetration. Penetration of videocassette recorders, for example, seems to be reaching a plateau at between 60 and 65 percent. With respect to computers, while 21 percent of all respondents in a survey conducted by AT&T, Consumer Federation of America, and the American Association of Retired Persons said they owned one, the figure was 15 percent for Black respondents, 6 percent for those with incomes below \$10,000 a year, and 3 percent for those aged 65 and over. The average member of the Boston Computer Society—at 23,000 members the country's largest computer-users group—earns \$50,000 a year, about double the Nation's median annual income.<sup>162</sup>

Part of the reason for this trend may be the increasing range of available services and capabilities, with a corresponding range of prices and fees. In the past, a household either had a telephone or it didn't. Individuals could either get a book or periodical, or they couldn't. They could either send a letter or they couldn't. Today, a telephone subscriber can have touch-tone service, custom-calling services, measured service, wide-area calling, speed-dialing, cellular service, and any number of other features. A bibliographic search can be done in the card catalog—the old-fashioned way—or via one of several different computer databases, containing either citations only or full copy. A text message can be sent via paper mail, electronic mail, facsimile, or overnight courier. In short, the range of communication options is much wider.

<sup>156</sup>Others cite examples such as increasing availability of diverse video programming and new calling services as evidence of benefits accruing to a large number of Americans. Call-waiting, for example, offers the same flexibility previously provided by a second telephone line—at a fraction of the cost.

<sup>157</sup>Ben Compaine, "Information Gaps: Myth or Reality," *Telecommunications Policy*, March 1986, p. 11.

<sup>158</sup>*Ibid.*

<sup>159</sup>Project Summary, Joint Telecommunications Project, Consumer Federation of America, American Association of Retired persons, and AT&T > Feb. 12, 1987, p. 21. The majority of households without telephones had incomes below \$10,000 per year. Other studies show that although 92 percent of all households have a telephone, only 81 percent of Black and Hispanic households have one. Entire States fall well below the national average, as do many inner city areas. See also "Low-Income Households in the Post-Divestiture Era: A Study of Telephone Subscribership and Use in Michigan," study prepared by the Michigan Citizens Lobby for the Michigan Divestiture Research Fund, October 1986. These figures are especially significant because studies have shown that people are likely to reduce their spending on medical care and food before they will take a cut in telephone service. "Let's Talk Telephones," Telecommunications Consumer Coalition, 1987, as cited in William Evans, "Towards an Equitable Information Age: Comments and Suggestions Regarding Recent OTA Proposals," Temple University, unpublished paper, Mar. 16, 1987.

<sup>160</sup>Book readership rises progressively with income, from 35 percent of those earning less than \$15,000 per year to 70 percent of those making more than \$40,000. Cole (cd.), *op. cit.*, footnote 58.

<sup>161</sup>Carey, *op. cit.*, footnote 30, p. 7.

<sup>162</sup>Boston Computer Society, and U.S. Bureau of the Census, "Current Population Reports." Such data go on and on. One study found, for example, that penetration of custom-calling services [call-waiting, call-forwarding, and three-way calling] was 34 percent among households with yearly incomes over \$50,000, 32 percent in the \$35,000 to \$50,000 group, and 23 percent in the \$25,000 to \$35,000 group. "Custom Calling and the Promise of Enhanced Consumer Communications," *Yankeevision*. The Yankee Group, January 1987. For videotex, of the households subscribing to current home systems, the average annual income is estimated to be in excess of \$36,000, with one-half of those earning more than \$50,000. "Videotex User Survey: 1986," Link Resources, July 1986, p. 1.

Another relevant development is the recent proliferation of different types of communication hardware available for use in the home. Until the 1970s, communication hardware for the home consisted of telephones, radios, and TVs. Today, there is a bewildering variety of hardware—from answering machines to fax machines to digital TVs to modems—that can add hundreds or thousands of dollars to the traditional household communication budget.<sup>163</sup>

It is difficult to determine whether this variety of options and affordability levels will translate into a more communication-stratified society, or what the implications of such a society might be. For know-how and motivation play a large role.<sup>164</sup> People in all income brackets write letters to the editor and call in to talk shows. Moreover, people in all income brackets suffer the frustrations of the new technological environments. For example, an estimated one-third of investment-software buyers eventually scrap their purchases “because the software baffles them.”<sup>165</sup> And, according to the Joint Telecommunications Project study, people at all income levels had similar perceptions of the difficulty of getting information about equipment repair and local service problems.<sup>166</sup> On the other hand, it is also clear that there is a strong relationship between access to the new technologies and empowerment. A recent study by the National Assessment of Educational Progress, for example, found that “computer competence” among students was linked to having access to a computer in their home, just as traditional literacy has been linked to home-support variables in the past.<sup>167</sup>

In some cases, the difference between access to traditional technologies and access to a new technology is one of convenience. Convenience has always been a basis for price discrimination in communication—if you could afford a book, for example, you could buy it and keep it. Otherwise, you could borrow it from the library and would eventually have

to return it. But convenience may take on a different import in the emerging technological environment where ease of use seems to make the difference between use and nonuse.

One concern for policymakers may be to assure that pricing structures and conditions do not exacerbate the problem of stratification of access. In the Joint Project study, three-quarters of those without telephone service said they couldn’t afford deposits and other one-time costs of establishing telephone service, while only one-quarter said they could not afford the monthly service charge.<sup>168</sup> The lack of a credit card may be another such barrier, as they are a common prerequisite for subscribing to many online services.

Another concern is that the increased use of emerging communication systems may erode the revenue bases—and therefore raise the costs—of traditional, shared systems such as the U.S. Postal Service, the telephone system, and libraries. Traditionally, these systems exploited economies of scale to make basic communication capabilities and tools widely affordable.

The role of such shared facilities will need to be further examined, and possibly expanded, to consider the provision of affordable access to emerging technologies. Today, individuals who cannot afford a facsimile machine, a computer, or some other type of tool must be able to pay high one-time usage fees for access at commercial outlets (\$10 per hour for use of a computer, for example, and \$5 per page for facsimile machines). Much debate has centered around the allocation of the costs and benefits of such shared systems, particularly libraries and the telephone networks. Telephone companies, for example, are offering new services (such as custom-calling) for substantial additional fees. Some claim that all ratepayers have subsidized the development of these networks, developing hypothetical “ratepayer equity,” and should have equal access to such services without having to pay more.

<sup>163</sup>Unless external expenditures drop, such as for movies, but this may not be the case.

<sup>164</sup>Conversely, technological know-how does not always translate into socioeconomic success. Jane Uebelhoer of ACORN points out that “a lot of the new dead-end, lower-paying jobs require computer literacy.” Personal communication, Dec. 22, 1987. New technology can both reduce and raise the level of skills required to function effectively in various situations.

<sup>165</sup>“Gearing up: More Small Investors Turn to Computers for Assistance,” *The Wall Street Journal*, June 25, 1987.

<sup>166</sup>Joint Telecommunications Project, op. cit., footnote 159.

<sup>167</sup>Michael E. Martinez and Nancy A. Mead, “Computer Competence: The First National Assessment,” *National Assessment of Educational Progress*, Princeton, NJ, April 1988. Even Everett Rogers, who denies that there is any functional need for a computer in the home, says that: “One of the main functions of home computers is to learn how to use a computer.” Rogers, op. cit., footnote 141.

<sup>168</sup>Joint Telecommunications Project, op. cit., footnote 159.



### System Design and Support Factors

From the catalogs of the very first libraries to the switchboard operators of the earliest telephone system, communication systems have always provided guidance and assistance, whether in human or technological form, to their users. Today, the extent and nature of such guidance and assistance is at the crux of many debates over the design of future communication systems, and many feel that the results of these debates will strongly influence the way in which individuals use the technology.

The features in question are the means by which individuals interact with and discover options within their communication and information environment. In technology circles, they are known as “navigational tools” and “interfaces.” But most laymen think of them as an unrelated collection of tools and aids—from physical systems like telephone books,<sup>169</sup> TV guides, newspaper headlines, and computer menus, to human helpers like librarians, teachers, and friends. These tools and resources are vital to our ability to communicate. \*70

There is much evidence that individuals are not as aware as they might be of their communication options, and that this lack of awareness is a barrier to use of communication systems. In studies of cable TV viewers, for example, researchers have found that viewers are not very aware of the different channels available to them over cable, let alone the different programs.<sup>171</sup> And a big problem in libraries, according to Carol Henderson of the American Library Association, is that people go away thinking “there’s nothing there” because they don’t know

what databases, or sources in general, are available.<sup>172</sup> Indeed, research shows that individuals’ communication behavior is very often dictated simply by chance circumstances—viewing “whatever is on” or reading whatever happens to cross their paths.<sup>173</sup>

Not only do people not know what communication options are available, but they often lack crucial information about pricing and conditions of use—a deficiency that can also be a major barrier to use.<sup>174</sup> Since the divestiture of AT&T, consumer advocates have consistently complained about complicated pricing structures, inconsistent pricing, and lack of a standardized source of information about such pricing.<sup>175</sup> Due to competition, there are more services available and more complex pricing schemes to go with them.<sup>176</sup> And information on long-distance rates and calling procedures is no longer included in the one place people typically think to look—the telephone book.

Compounding this lack of awareness of communication options and conditions has been their recent proliferation, dubbed by some as “information overload.” The effects of such proliferation, which were first noted in marketing studies of how much product information consumers could digest, are highly disputed. Most agree, however, that by almost any measure the flow of information is quickening. For example, the number of books published annually in the United States increased from 28,600 in 1965 to 51,000 in 1986.<sup>177</sup> As Pool noted:

<sup>169</sup>The telephone book is the most frequently used reference source—21 percent of the population consult it on an average day. The runner-up is material on food preparation, at 18 percent. Neuman, op. cit., footnote 8, p. 8.

<sup>170</sup>Mary Culnan, “The Dimensions of Perceived Accessibility to Information: Implications for the Delivery of Information Systems and Services,” *Journal of the American Society for Information Science*, September 1985.

<sup>171</sup>Carrie Heeter and Bradley Greenberg, “Cable and Program Choice,” Zillmann and Bryant, op. cit., footnote 6.

<sup>172</sup>& another example of the importance of awareness: when a cable TV experiment went awry in southern Maine last year, a university extension course on firefighting intended for local firehouses was piped instead into all local residences. The next day, the university was flooded with requests to take the course, and enrollment tripled.

<sup>173</sup>Neuman, op. cit., footnote 8, p. 7.

<sup>174</sup>A good illustration of this is the controversy over price-bundling for pornographic “dial-it” services. Peter Huber notes that when the costs of the pornographic service are billed separately from the costs of the telephone time for these calls—that is, when people can figure out how much is going to the pornography provider and how much to the phone company—use falls off sharply. Huber, op. cit., footnote 97, sec. 8.7.

<sup>175</sup>& fear of the complexity of telecommunication rate structures is the main obstacle to getting nonprofit organizations onto computer networks with each other, according to Denise Vesuvio, Executive Director, Public Interest Computer Association, Washington, DC.

<sup>176</sup>One recent study conducted in Michigan showed that 54 percent of telephone users did not know which type of service they were receiving. Almost 20 percent said they did not know why they chose the type of service they did. Another 20 percent said they chose their service because it was the least expensive. “Low-Income Households in the Post-Divestiture Era: A Study of Telephone Subscribership and Use in Michigan,” study prepared by the Michigan Citizens Lobby for the Michigan Divestiture Research Fund, October 1986.

<sup>177</sup>Bowker Annual, 1987.

More and more material exists, but limitations on time and energy are a controlling barrier. . . 178

Daniel Dennett agrees:

Technology has created innumerable opportunities for us to know, and to act. We want to deal responsibly with this bounty, but we do not know how. When we turn to the question of which priority should engage our best efforts, we drown in the available information, unable to make truly principled decisions.<sup>179</sup>

Computer researcher Thomas Malone recognizes a similar frustration among participants in electronic mail networks who:

. . . often adopt crude methods, such as removing themselves entirely from [electronic mailing] lists that are of occasional interest, in order to avoid being inundated. 180

In this context of information overload and serendipitous communication behavior, minor details in the design of the tools and systems that guide and assist individuals are often the deciding factors in determining communication behavior. The impact of channel selectors, for example, has been shown to be subtle and complex. Researchers have found that subscribers to older cable systems that have two dials (one for the cable and one for the broadcast channels) generally tend to concentrate their viewing on the channels on either one or the other.<sup>181</sup>

A good example of how design changes can change an individual's communication behavior is the experience of public television. When cable television came along, with its tuner mechanism that encouraged sequential scanning of channels, public television's ratings improved markedly. No longer

easily identified with a knob position, the Public Broadcasting Service became just another video channel. 182 In light of the individual's need for more and better assistance in using communication systems, therefore, it is appropriate to consider what the role of policy might be in encouraging systems that provide such assistance. First, however, it is important to realize that, increasingly, the technological tools that provide guidance and assistance are viewed by programming and service providers as a new strategic opportunity to influence individuals. Indeed, there is a very fine line between many access tools—like telephone directories and advertising. This is especially true in the emerging “online” electronic environment, where the structure and emphasis of access mechanisms like menus and indexes may play a greater role in determining behavior than in traditional media.<sup>183</sup> The implication of this is that any attempt by policy makers to structure such access mechanisms will be inherently controversial.

The promise of the new technology is to provide cheaper, more understandable, and more customized guidance and support to all users of communication systems. New computer-based directories, for example, should be able to present information in different forms to different individuals. Many scholars, who claim that information gaps are largely a result of the way information is presented, see in new technology the potential to help close such gaps.<sup>184</sup> A simple example is that of language barriers. The Hispanic population is growing four times faster than the U.S. population as a whole.<sup>185</sup> But most telephone-based information services (directory assistance, operators, etc.) provide English-only service.<sup>186</sup> The use of dual-language online databases

<sup>178</sup>Thiel de Sola Pool, “Tracking the Flow of Information,” *Science*, vol. 221, No. 4611, Aug. 12, 1983, p. 609.

<sup>179</sup>Daniel C. Dennett, “Information, Technology and the Virtues of Ignorance,” *Daedalus*, vol. 115, No. 3, summer 1986, p. 148. He continues: “Our responses exhibit a sort of Rorschach magnification of whatever minor personal proclivities emerge from the noise of competing and imponderable alternatives.”

<sup>180</sup>Thomas W. Malone et al., “Intelligent Information-Sharing Systems,” *Communications of the ACM*, vol. 30, No. 5, May 1987, p. 390.

<sup>181</sup>Heeter and Greenberg, op. cit., footnote 171.

<sup>182</sup>Robert Lippincott, former director of interactive media at WGBH-TV, Boston, MA, personal communication, Apr. 21, 1987. “It [cable] put us on the menu in a way that we were never on the menu before.”

<sup>183</sup>Independent film producer, Lawrence Daressa, sees new technology as an opportunity to increase public awareness about available programming, particularly educational and informational videos. Daressa, who notes that how program listings “play” is almost as important as the quality of the programs themselves, declares that “government should take a position against couch-potatodom” by subsidizing the marketing of such programming. Personal communication, June 22, 1988.

<sup>184</sup>For example, Brenda Dervin, “Categorization of Communication Users,” OTA contractor report, September 1987.

<sup>185</sup>Joe Schwartz, “Hispanics in the Eighties,” *American Demographics*, vol. 10, No. 1, January 1988, p. 43.

<sup>186</sup>One company is making pay telephones that, in addition to having an LCD display for operating instructions or advertising messages, have voice-instruction in a choice of languages. *The Star-Ledger*, Trenton, NJ, Feb. 9, 1987.

and other systems such as voice synthesizers and computerized language translators could eliminate this problem.

Another potential of the new technology for easing the individual's communication burdens is the creation and adoption of software tools to help people filter, sort, and prioritize their communication. Such tools are currently under development.<sup>187</sup> They may allow individuals to better control their information diet, to be more consistent, and to track

specific topics rather than whatever happens to present itself randomly.<sup>188</sup>

Critics note that such tools will only be effective, however, to the extent that an individual's communication environment is integrated—that is, to the extent that one “navigational tool” provides access to a variety of resources and services. \*89 Some have likened the current level of integration in computer-based media to having four different telephone sets on your desk, three to call different areas of town and one to call long-distance.<sup>190</sup>

<sup>187</sup>Malone describes some of the subtle criterion which these filters can be programmed to base their decisions: the characteristics (status, reputation, etc.) of a message's sender; the “cost” of reading a message (e.g., how long it is); and the “cost” to the sender of sending it, among others. He also acknowledges that the challenge is great: “People may have difficulty knowing what they want and do not want. . . until they have seen it.” Malone et al., op. cit., footnote 180.

<sup>188</sup>“The effort required to monitor all the available media for a snippet of information or entertainment that resonates closely with one's tastes and interests is usually more than most are willing to invest,” says Neuman. “The result is that the average audience member satisfies, following primarily the most widely-publicized bestsellers in each medium.” Neuman, op. cit., footnote 8, p. 210.

<sup>189</sup>Such as early telephone operators, who could tell you what was playing at the movies, where the town doctor was, what time it was, or connect you to somebody else.

<sup>190</sup>Others note that existing paper catalogs like the Yellow Pages are hard to use because they lack integration. “What's needed is a thesaurus-like prompting system,” says Lloyd Morrisett, “to help the person find the information.” Morrisett, in Rice (cd.), op. cit., footnote 86.

# Crosscutting Communication Issues and Alternative Policy Strategies for Their Resolution

The United States has entered a new communication era. Recent advances in information storage, processing, and transmission technologies, occurring in a partially deregulated and more competitive economic climate, are rapidly reconfiguring the Nation's communication infrastructure. The revolution in computers and communication technology has already transformed the regulatory and market structure of communication-related industries, dramatically changing the way in which information is created, processed, transmitted, and made available to individual citizens and institutions.

Changes are also taking place at the international level. Because the new technologies encourage the flow of, and the demand for, information-based products and services across national borders, they are wearing away the lines that historically have divided domestic and international communication systems and markets. Communication is now one of the fastest growing sectors in the international marketplace, and international conglomerates are increasingly being formed to provide products and services both at home and abroad.

New communication and information technologies hold promise for a greatly enhanced communication system that can meet the changing communication needs of an information-based society. At the same time, however, these technologies are generating a number of significant social problems. How

these technologies evolve, and who reaps their benefits and bears their costs, will depend on decisions currently being made in both the public and private sectors. This study provides a context for evaluating these decisions.

To assist Congress in determining an appropriate role for the Federal Government in the development and use of these new technologies, and based on the analysis presented in previous chapters, Part III will outline:

- the current problems or issues that might provoke the need for a Federal policy response,
- some alternative ways for the Federal Government to address these issues, and
- the potential effects of policy alternatives on different players and societal realms.

Other chapters identify and discuss policy issues as they relate to specific sets of players in particular realms of social life. Chapters 9 through 13 will address these issues as they overarch and cut across one another. While all five dimensions of the communication infrastructure discussed in Part III are critical, they cannot all be maximized. Trade-offs are required. For example, providing for security is often at the expense of access and interoperability; and interoperability sometimes delays innovation and modernization.

## Chapter 9

# Equitable Access to Communication Opportunities

## CONTENTS

	<i>Page</i>
INTRODUCTION .....	243
THE PROBLEM .....	243
Defining Universal Service .....	253
Implementing Universal Service .....	254
STRATEGIES AND OPTIONS .....	254

### **Boxes**

<i>Box</i>	<i>Page</i>
9-A. Comparative Shopping for Intrastate InterLATA Directory Assistance .....	247
9-B. Problems Encountered in Setting up an Interactive Data Network .....	248

### **Figures**

<i>Figure</i>	<i>Page</i>
9-1. Changes in Allocation of Advertising Revenues in Television .....	244
9-2. Comparison of Growth in Telecommunication and MIS Spending, 1988 and 1993. ....	249
9-3. 1988 Product, Revenue Breakdowns for Time and Warner. ....	251
9-4. Congressional Strategies and Options To Address Access to Communications Opportunities .....	256

### **Tables**

<i>Table</i>	<i>Page</i>
9-1. A Decade's Decline in Network Share .....	245
9-2. Consumer Spending: Pay-Per-View v. Competitors , .....	245
9-3. Strategic Advantages of Recent Developments in the LAN Industry .....	252
9-4. Sources of Public Broadcasting Income, 1987 .....	257

# Equitable Access to Communication Opportunities

## INTRODUCTION

In the United States, the government has traditionally fostered public access to information on the grounds that its widespread use was critical to a healthy polity and economy. For example, the government long permitted the postal service to charge below-cost rates for newspapers and magazines. State and Federal telephone regulators have endorsed tariffs that maintained low rates for local telephone service at the expense of higher rates for long-distance service. Similarly, commercial broadcasters were allowed to charge market-based prices for carrying advertising messages, but were required to spend a portion of these revenues on the coverage of public affairs to meet public interest standards such as the Fairness Doctrine. Until 1987, cable operators were required to carry local broadcast stations, and many of them still must provide public access to producers free of charge.

The provision of access requires a number of things. In addition to communication pathways, information content, and audiences, individuals also need to have the skills—as well as access to the navigational tools—required to locate these resources in a timely fashion and in a form appropriate for their needs. In all realms of life, unequal access to these resources leads to disparate advantage, and ultimately to inequalities in social and economic opportunities.

## THE PROBLEM

OTA found that changes in the U.S. communication infrastructure are likely to broaden the gap between those who can access communication services and use information strategically and those who cannot. Moreover, the people most likely to be adversely affected will be those for whom the new communication technologies are held out as a means to improve their circumstances—the poor, the edu-

cationally disadvantaged, the geographically and technologically isolated, and the struggling small business.

One barrier to access that maybe much greater in the future is cost, given shifting subsidies due to deregulation and changes in the financing and operation of communication services. Another barrier is the discretionary power of media owners to determine what information will be disseminated. OTA found, for example, that the first amendment is being used more and more as a device to protect the economic interests of media owners. In a number of instances, this can actually compromise the goal of freedom of expression.

OTA identified five major factors that are likely to contribute to these kinds of access problems:

***Factor 1: Shifting subsidies due to cost-based regulation and changes in the financing and operation of communication services.***

*The prices that individuals pay for communication and information services are determined to a large degree by how these services are financed and how their costs are allocated. Where there are cross-subsidies, as in the historical cases of the telephone and postal service, or where costs are borne by advertisers willing to pay for information distribution, consumers may be charged less than the actual service cost. Financial arrangements such as these can facilitate widespread access to communication and information services.*

Technological change, together with changes in the regulatory structure, has led many communication providers to try to price access closer to real costs and to structure their prices based on measured usage, thereby eliminating many traditional sources of subsidies.<sup>1</sup> In telecommunication, for example, a regulated monopoly has been replaced by what are more or less competitive markets in which regula-

<sup>1</sup> It is **important** to note **that** the problems involved in identifying real costs have proven to be intractable, and they are **likely** to **become** even more difficult to solve in the future, given the deployment of the intelligent network. For a discussion of past and future problems entailed in identifying costs, see Anthony G. Oettinger, "The Formula is Everything: Costing and Pricing in the Telecommunications Industry," Program on Information Resources Policy, Center for Information Policy Research, Harvard University, Cambridge, MA, 1988. See also Roger G. Nell, "Telecommunications Regulation in the 1990s," Stanford University, Center for Economic Policy Research, No. 140, August 1988, p. 14; Alfred Kahn and William B. Shew, "Current Issues in Telecommunication: Ricing," *The Yale Journal of Regulation*, vol. 4, No. 2, 1987, pp. 191-256; Richard J. Solomon and Loretta Anania, "Paradoxes and Puzzles of Digital Networks, Part 2," *Telecommunications*, February 1987, pp. 28,30, 32; and Bruce L. Egan, "Costing and Pricing for an Integrated Digital Telecommunication Network," *Telecommunications*, November 1987, pp. 47, 49, 50, 52, and 54.

tion plays a greatly reduced role. In this deregulatory climate, where competition is not only allowed but also fostered, discrepancies between costs and prices are increasingly less tenable. For wherever prices are kept artificially high, users will seek alternative, private solutions to meet their communication needs. To avoid this kind of bypass of the public telecommunication network, the Federal Communications Commission (FCC) has begun to shift costs from interstate interexchange service to local exchange service by imposing subscriber line charges and by capping the interstate share of local plant costs assigned to interstate calls.<sup>2</sup>

Changes are also taking place in how mass media are being financed and provided. Whereas in the past much of the Nation's entertainment and news programming was sponsored and subsidized by advertisers, and thus was available to a broad segment of the population at a reduced price, today this is less and less the case.<sup>3</sup> Given the growing number of distribution channels, there is now much greater competition for audience share and advertiser revenues, as can be seen in figure 9-1.<sup>4</sup> These developments have had a significant impact on the three major broadcast networks, whose audience share has been declining over the past decade, as illustrated in table 9-1. This year, for the first time, the networks' prime-time viewing audience fell below 70 percent to 67.4 percent,<sup>5</sup> while their share of total television advertising revenues is expected to decline from 36 to 30 percent.<sup>6</sup> Industry pundits expect this erosion of network audiences and loss of advertising share to continue into the 1990s.

Figure 9-1-Changes in Allocation of Advertising Revenues in Television

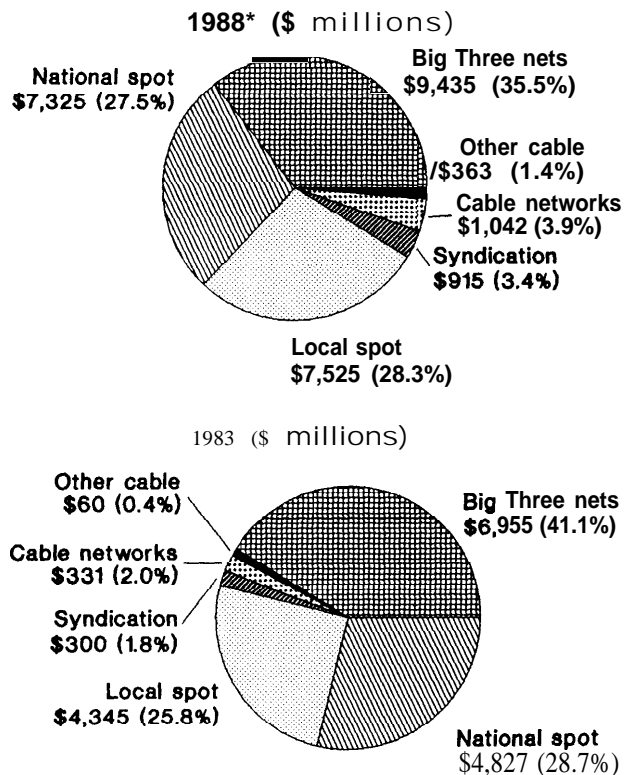

SOURCE: *Channels/Field Guide, 1989*; McCann-Erickson; cable data from Paul Kagan Associates Inc. Reprinted with permission.

Meanwhile, advertiser-based cable service has registered significant gains, both in terms of its audience share (up by 30 percent) and advertising

<sup>2</sup>A number of people have argued that the move to bring prices closer to costs has, in fact, not proceeded quickly enough due to the resistance of State policymakers. For one such discussion, see Robert W. Crandall, "Fragmentation of the Telephone Network," Paula R. Newberg (ed.), *New Directions in Telecommunications Policy, vol. 1, Regulatory Policy: Telephony and Mass Media* (Durham, NC: Duke University Press, June 1989), pp. 222-246.

<sup>3</sup>It should be noted that exactly how much of a reduced price is an important public policy issue. As Ben Bagdikian has pointed out, advertiser-based media may not be a bargain for consumers because the costs of advertising may be passed on in terms of higher prices. These prices reflect not only direct costs of the product advertisement; they also reflect the role that advertising plays in fostering oligopoly by raising the cost of entry into established markets. See Ben H. Bagdikian, *The Media Monopoly* (Boston, MA: Beacon Press, 2d ed., 1987), especially ch. 8, "The High Cost of Free Lunches," pp. 134-151.

On the other hand, as Victor E. Ferrall, Jr., has noted, "It is often said that 'free' television is not in fact free because consumers pay for the programming they receive by paying for the cost of advertising, which is included in the price of the products advertised on television. True enough, but this 'price' for television programming is totally separate from and unrelated to use of the television service. Programs are available at no charge to viewers who do not choose to purchase advertised products and, conversely, product purchasers pay for television advertising whether or not they view the programs in which the product was advertised, or even own a television receiver." Victor E. Ferrall, Jr., "The Impact of Television Deregulation on Private and Public Interests," *Journal of Communication*, vol. 39, No. 1, Winter 1989, p. 10. For discussions of the role of advertising, see John E. Calfee, "Advertising and Market Performance: An Interpretative Survey of the Literature," University of Maryland, prepared for the National Association of Broadcasters, Jan. 12, 1988.

<sup>4</sup>The relationship between audience share and advertising revenues is becoming more and more pronounced, given the development and use of audience-measuring devices such as people meters.

<sup>5</sup>"Three-Network Viewing Falls Below 70%," *Broadcasting*, Apr. 17, 1989, p. 29.

<sup>6</sup>"Study Predicts Cable Ad Revenues to Triple by 1995," *Multichannel News*, Nov. 21, 1988, p. 69.

<sup>7</sup>Ibid.



**Table 9-1-A Decade's Decline in Network Share**

Year	ABC	CBS	NBC	Combined total
1978-79	34%	30%	27%	91%
1979-00	31	31	28	90
1980-81	29	30	26	85
1981-82	29	30	24	83
1982-83	28	29	24	81
1983-84	27	28	23	78
1984-85	24	27	26	77
1985-86	23	26	27	76
1986-87	22	25	28	75
1987-88	22	22	26	70

SOURCE: Nielsen Media Research. Reprinted with permission.

**Table 9-2--Consumer Spending: Pay-Per-View v. Competitors**

Medium	1987		1996	
	spending (\$billions)	Percent of total	spending* (\$billions)	Percent of total
Pay-per-view	0.06	0.3	2.60	6
Cable TV	6.59	32.0	17.32	40
Home video	6.18	30.0	12.99	30
Movies	3.91	19.0	5.63	13
Pay able.	3.71	18.0	4.76	11

● Projected

SOURCE: *Channels/Field Guide 1989*, p. 102. Reprinted with permission.

revenues, which are predicted to triple by 1995.<sup>7</sup> Also cutting into the network audience share is the growth of pay cable and pay-per-view services. Pay cable can now be found in 28.8 percent of all TV homes,<sup>8</sup> while the number of homes being offered at least one pay-per-view channel now totals 6.8 million, an increase of 70 percent from 1978 to 1988.<sup>9</sup> That this trend toward media fragmentation is likely to persist can be seen from table 9-2, which compares 1987 and 1996 consumer spending per medium and each medium's percentage of total media spending.

In the absence, or with the decline, of traditional subsidies, the Federal Government will need to determine if and how it should act to ensure equitable access to communication and information services. If, for example, entertainment programming is increasingly provided on a pay basis rather

than through advertiser-based distribution, the cost of access may be too high for some. This issue of increasing costs has been raised most recently with respect to cable television. At recent hearings of the Senate Antitrust Subcommittee, Senator Howard Metzenbaum, for example, claimed that, since the deregulation of the cable industry in 1984, rates for cable service have risen on an average of 32 percent, making it the highest rate increase for all service commodities.<sup>10</sup>

As described in chapter 12, the amount of subsidy available for communication services is also likely to be decreased in the future to the extent that business-users, who have traditionally subsidized residential and small-business users, migrate from the public network and set up their own telecommunication systems. Under such circumstances, fewer resources will be available for publicly shared communication services. Similarly, if communication services that were once provided through the public network, and thus served to cross-subsidize one another, are now unbundled and provided in the marketplace, many small users may have to pay considerably more for services.

**Factor 2: Increased transaction costs and increases in the complexity of the tools required to access and effectively use information.**

To be effective communicators, people need to know how to use the technology through which their messages are mediated. Moreover, to find information relevant to their particular needs, they must be able to locate the appropriate source. To use this information strategically—whether in politics, business, or other realms—they must be able to find it in a timely fashion. Finally, to communicate effectively with others, individuals not only need to identify their audiences and the most cost-effective means of exchange, but they must also be able to package their messages in the most appropriate technological format. These prerequisites represent the transaction costs of effective communication—costs that are often overlooked.

<sup>8</sup>Paul Noglows, "Hard Work pays," *Channels/Field Guide*, 1989, p. 89.

<sup>9</sup>Frank Lovece, "At the Crossroads," *Channels/Field Guide*, 1989, p. 102.

<sup>10</sup>*The Washington post*, Apr. 13, 1989, p. D-24. At the request of Senator Metzenbaum, the General Accounting Office undertook a study of cable rates from 1986 to 1988. The study concluded that basic cable rates in Ohio had increased during that period by 27 percent. See U.S. Congress, General Accounting Office, *Ohio Cable Television Rate Increases, 1986 to Present* (Gaithersburg, MD: U.S. General Accounting Office, September 1988). Citing figures from the Bureau of Labor Statistics, representatives of the cable industry claim that the average subscriber's bill has increased by only 14.5 percent. They note, moreover, that this increase is not particularly high, given that rates prior to deregulation were artificially low. See "The Big Chill on Capitol Hill," *Broadcasting*, Apr. 17, 1989, pp. 27-29; and "Inflation's the Limit on Basic Cable Rates," *Broadcasting*, May 22, 1989, pp. 27-28.

In the past, many transaction costs, especially in the area of telecommunication, were hidden. For example, as an integral part of the product they sold, providers of telephone services included their own technical expertise and assured interconnection and connectivity. In addition, they provided services such as directories, maintenance, protocols, and routing. Today, while residential and business users benefit from a greater choice of communication services, they must assume the corresponding transaction costs on their own.<sup>11</sup>

The typical household user, for example, needs to develop the expertise to select the best provider of equipment and service, recognize problems, and negotiate or perform necessary repairs.<sup>12</sup> According to Carl Oppedahl, a telephone buff who advises consumers on such matters,<sup>13</sup> in order to be an educated consumer of communication services one needs—among other things—to:

- understand the difference between a local operating company and an interexchange carrier and the responsibility of each for providing service;
- know the difference between central offices equipped with step-by-step, crossbar, and electronic switching systems and be aware of the kind of services available from each;
- understand the rationale and implications of choosing between measured or flat-rate services or among other classes of services; and
- know that an interface is simply another name for a jack.

Box 9-A, which outlines the steps entailed in comparative shopping for intrastate interLATA (local access and transport area) directory assistance, provides another picture of the numerous factors the consumer now needs to consider when choosing a service.

Businesses, too, will have to take greater responsibility for configuring their own communication services, and for meeting their own particular communication needs. In fact, as described in chapter 5, many businesses regard this post-divestiture development as an economic opportunity that allows them to employ their communication and information systems strategically as a competitive weapon to enhance their position in the marketplace. However, putting together and maintaining a communication network not only entails considerable expense; it also requires a high degree of expertise and technical skill, as many businesses trying to develop their own private networks have rapidly discovered.<sup>14</sup> Whereas in the past, vendors typically performed a number of key functions—such as providing network management, developing industry standards, designing an optimum system architecture, planning the introduction of new technologies, and evaluating and assessing alternative products and services—today these tasks are either performed or commissioned by business-users themselves.<sup>15</sup> For one picture of the problems faced by business-users, see box 9-B.

To meet the needs of business-users, new companies are emerging and old ones are reorganizing to better position themselves to take part in what is now a very lucrative systems integration market. According to the market research firm, International Data Corp., for example, the system integration market is growing at an estimated annual rate of 20 percent, with revenues increasing from \$8 billion in 1987 to \$22 billion in 1993.<sup>16</sup> However, the costs of obtaining such services, whether by creating expertise internally or by purchasing services externally, can be considerable, especially given the lack of standards, the dearth of network management tools, and a multivendor environment. It is not surprising, therefore, that corporations are spending a steadily

<sup>11</sup>Some of the transaction costs entailed in employing new technologies may be offset if the technologies reduce the cost of conducting business or carrying out other activities. For example, by using new technologies, a consumer might reduce the costs entailed in searching for the best buy.

<sup>12</sup>Some household users have conquered this challenge, but many others have not. See Consumer Federation of America (CFA), American Association of Retired Persons (AARP), and AT&T, *Joint Telecommunications Project*, paper presented at the annual assembly of the Consumer Federation of America, Feb. 12, 1987.

<sup>13</sup>See, for example, his advice to consumers in Cad Oppedahl, *The Telephone Book Getting What You Want and Paying Less For It* (Chesterland, OH: Weber Systems, Inc., 1987).

<sup>14</sup>For discussions of users whose problems led them to give up their efforts to develop private networks, see John Foley, "Merrill Shifts Gears: Solicits Network Bids," *CommunicationsWeek*, Oct. 31, 1988, pp. 1, 58; see also John Foley, "Problems Force Users to Retrench," *CommunicationsWeek*, Nov. 7, 1988, pp. 1, 57; and Kelly Jackson, "Red Ink Downs Net," *CommunicationsWeek*, Nov. 21, 1988, pp. 1, 43.

<sup>15</sup>Sandra G. Tuck and A.M. Webster, "Vendors and Users: They Need to Start Building Together," *CommunicationsWeek*, CLOSEUP, Feb. 29, 1988, pp. 12-14. See also David Gabel, "Control of Large Networks No Dog-and-Pony Show," *Computerworld*, Nov. 7, 1988, pp. 83-89.

<sup>16</sup>For a discussion, see Mark Breitbart, "Systems Integration Surge," *Computerworld Focus on Integration, Special Issue*, Feb. 6, 1989, pp. 29-33. See also Neil Watson, "Modems and Multiplexers: A Market Makeover," *CommunicationsWeek*, CLOSEUP, Nov. 14, 1988, pp. C7-C9.

### **Box 9-A-Comparative Shopping for Intrastate InterLATA Directory Assistance**

“*These* calls, because they are to points outside of your LATA, are forbidden fruit to your LOC. Your LOC is required to give the call over to your primary long-distance carrier. Yet the rate is set by your PSC [public service commission], and the number of listings you get is set by your PSC, just as they are for LOC-handled calls. You may find that you can save money by using 10XXX codes to get a free call or two from a secondary carrier. Then again, the pricing policy set by your PSC may allow one or more free DA calls through your primary carrier.

The DA operator who answers works for an LOC (probably your LOC), yet if something goes wrong you will only be able to get credit by calling your long distance carrier.

#### **Puzzle 1: Area Codes Straddling LATA Boundaries**

Colorado is all area code 303, and is split into two LATA--the Denver LATA and the Colorado Springs LATA. Caroline lives in the Denver LATA and her exchange has converted to Equal Access. Her calls to points in the Denver LATA are routed through the circuits of her LOC, while her calls to points in the Colorado Springs LATA are routed through the lines of her primary carrier, MCI. The central office computer is programmed with a list of all the phone exchanges in each LATA, which it uses to decide, on a call-by-call basis, whether to route the calls to the LOC's own lines or to the lines of MCI. If she dials 1-303-555-1212, and she has not yet quite decided whether to ask for a listing in Denver or for a listing in Colorado Springs, is this an intraLATA or interLATA call? How does her central office know whose lines to route the call to? Are the answers different if she asks for two listings, one in Denver and one in Colorado Springs?

These questions come up only if she allows the central office to decide the routing of the call. She could use 10222 to force the central office to route the call via MCI, or could use her LOC's 10XXX code (if they have one) to force the routing to her LOC's lines. In either case the price charged for the call is determined by the PSC, but the prices may not be the same.”

SOURCE: Carl **Oppedahl**, *The Telephone Book* (Chesterland, OH: Weber Systems, Inc. 1987), pp. 135, 136. Reprinted with permission.

increasing proportion of their budgets on communication services, as can be seen in figure 9-2. Nor is it difficult to understand why, given these circumstances, the majority of business-users (with the exceptions being among the largest corporate users) have yet to develop and deploy their communication networks in an optimal fashion.<sup>17</sup>

Shifting the direct burden of transaction costs to the communication-user has significant consequences for equity. In fact, it may further increase the gap between those who can access and use information strategically and those who cannot, since not every person or every business will be equally able to assume these costs. As chapter 8 points out, many Americans do not have the technical skills required to take advantage of the opportunities afforded by new technologies. Moreover, as chapter 5 describes, many businesses do not operate on a scale that permits them to become communication experts in their own rights. In the past, these transaction costs were essentially the same for everyone; increasingly, they are the basis for gaining competitive and strategic advantage.

### **Factor 3: Growth in the economic power and concentration of many media.**

As described in chapter 4, integration activities in the communication industries have generally been curtailed by antitrust law and the establishment of consent decrees, as well as by regulatory limitations of ownership rights. Recently, however, the FCC has sought to relax many of these rules, thereby encouraging rather than discouraging integration and multiple ownership. In the area of broadcasting, for example, the FCC has abolished the regional concentration rule, which prohibits the common ownership of three commercial AM, FM, or television stations where any two stations are located within 100 miles of the third, and where the primary service areas of any of the stations overlap. It has also eliminated the “top 50” rule, which generally prohibited those who owned or had interests in two or more very high frequency (VHF) stations in any of the top 50 television markets from acquiring VHF television stations in any of those markets. In addition, the FCC has raised the ceiling for multiple ownership from 7 to 12 in each broadcast service, provided that the audience reach of any entity in a particular service

<sup>17</sup>See, for one discussion, Steven Titch, Margie Semilof, and John Berrigan, “Missing Links,” *CommunicationsWeek*, CLOSEUP, Sept. 12, 1988, PP. C6-C9.

### Box 9-B—Problems Encountered in Setting Up an Interactive Data Network

“Recently, a major retail chain formed a technology task force to study alternatives for a new interactive data network. Competitive pressures had rendered its dial-up system obsolete. Senior management wanted anew, on-line network to connect 1,000 stores for credit verification, catalog look-up and point-of-sale data collection.

Salesmen from public packet switching network providers, private packet switching equipment providers, VSAT (very small aperture terminal) satellite suppliers, modem manufacturers and leased-line providers all submitted proposals—each promoting a different solution.

After months of analysis and review, the task force selected a modem-based network, using leased long distance data lines. Six months later, a new VSAT supplier came in and demonstrated how another architecture, one combining VSAT with intraLATA (local access and transport area) local-loop lines, could save the chain \$25 million over the next 5 years, or more than 30 percent of its expected costs under the recently signed contract.

Unfortunately, it was too late to switch.

In another situation, a senior sales representative for a major network provider had champagne bottles ready to pop for the expected award of a retail network connecting 7,000 locations. More than 18 months of work—including many late nights—had gone into the detailed system plan, layout and pilot tests. Senior management, involved in the later stages of the sales process, was counting on the contract to meet upcoming booking and shipment targets.

One week before the contract was to be awarded, the salesman learned that yes, he would win a contract—but for only 300 warehouses. The retailer finally had realized that its applications and data needs did not justify interactive capability for the remaining 6,700 stores. The shrunken contract nearly cost the salesman his job and set the manufacturer’s growth plan back two years.

In these examples, the ‘losers’—in the first case, the user; in the second case, the vendor—had failed to rigorously analyze all the alternatives to determine which would be fundamentally advantaged for the required applications. In both cases, critical expectations went unmet, and significant resources were wasted.”

SOURCE: Douglas A. Cogswell, “Clearing the Obstacles Takes a Plan of Attack,” *CommunicationsWeek*, CLOSEUP, Sept. 12, 1988, p. C14. Copyright 1989 by CMP Publications, Inc., @O Community Drive, Manhasset, NY 11030. Reprinted from *CommunicationsWeek* with permission.

does not exceed 25 percent of the national audience.<sup>18</sup>

Government efforts have also been under way to alleviate a number of the antitrust constraints imposed on the regional Bell operating companies (RBOCs) as part of the Modified Final Judgment (MFJ). In its triennial review of the telecommunication industry, the Department of Justice recommended, for example, that RBOCs no longer be restricted from manufacturing and from providing information and long-distance services, a position that was supported to a greater or lesser extent by both the National Telecommunications and Informa-

tion Administration (NTIA) and the FCC.<sup>19</sup> More recently, Congressmen Al Smith and Tom Tauke introduced legislation in the House of Representatives, The Consumer Telecommunications Act (H.R. 2140), that would allow RBOCs to provide information services, including electronic publishing, and to engage in manufacturing, given certain safeguards.<sup>20</sup> In the Senate, Senators John Breaux, Trent Lott, and Ted Stevens cosponsored a resolution (SR Con. Res. 34) that calls on the Senate to “determine whether, or the extent to which the Bell regional holding companies should be allowed to engage in forbidden businesses of manufacturing, information services,

<sup>18</sup>Thirty percent of the national audience if a minority station. Moreover, UHF stations count as only one-half a station. See Amendment Of Section 23.3555 of the Commission’s Rules, The Broadcast Multiple Ownership Rules, 4 FCC Rcd 1741 (1988). For a discussion of broadcast ownership rules, see Stanley M. Besen and Leland Johnson, “Regulation of Broadcast Station Ownership: Evidence and Theory,” Eli Noam (ed.), *Video Media Competition: Regulation, Economics, and Technology* (New York, NY: Columbia University Press, 1985).

<sup>19</sup>Peter W. Huber, *The Geodesic Network: 1987 Report on Competition in the Telephone Industry*, U.S. Department of Justice, January 1987; *NTIA Telecom 2000: Charting the Course for a New Century*, U.S. Department of Commerce, National Telecommunications and Information Administration, October 1988; and the FCC Comments, Mar. 13, 1987, *United Mates v. AT&T*, pp. 194-195.

<sup>20</sup>The bill specifically excludes changes in the ban against cable/telephone company cross-ownership as well as long-distance telephone service. It incorporates four provisions designed to prevent cross-subsidies, and calls on the FCC to draw up a number of rules and regulations to administer and enforce the law. Charles Mason, “MFJ Legislation Finally Debuts,” *Telephony*, May 1, 1989, p. 12, and Kathleen Killete, “Bill Hits Bells’ Case,” *communicationsWeek*, May 1, 1989, pp. 8, 79.

**Figure 9-2-Comparison of Growth in Telecommunication and MIS Spending, 1988 and 1993 (Percent of Total Operating Budget By Industry Sector)**

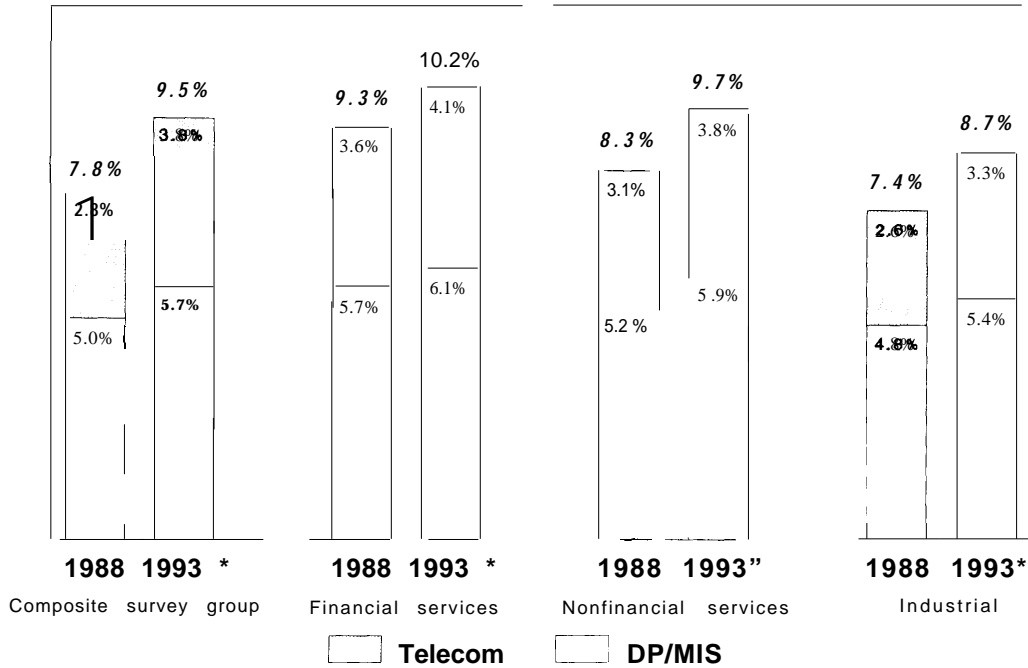

\*Projected

SOURCE: Copyright 1989 by CW Publishing Inc., Framingham, MA 01701

Reprinted from *Computerworld*, Jan. 16, 1989, p. 114.

and long distance.”<sup>21</sup> The FCC has also begun an inquiry on altering the Cable Communications Policy Act of 1984 to allow telephone-company entry into the cable industry,<sup>22</sup> a subject that Congress is likely to consider during 1990.

This changed regulatory climate is only one factor affecting the market structure and the degree of integration and concentration in communication-related industries. As described in chapter 3, technological developments have also had a significant impact. The convergence of technologies has blurred the boundaries that divide one industry from the other, reconfiguring economies of scale and scope and raising new opportunities for mergers, acquisitions, and joint ventures. As one financial

analyst, commenting on these developments in the entertainment field, has noted:

Dividing lines in the entertainment businesses are blurring . . . One side co-opts the other by buying it . . . The enemy becomes your friend.<sup>23</sup>

Seeking to take advantage of these opportunities and developments, large corporations have become owners of multiple broadcast properties in major cities, as well as cross-media owners; a number now own newspaper and radio or television stations in the same geographical area. As Ben Bagdikian has noted:

Compounding the trend [towards concentration] has been the practice of companies already dominant in one medium like newspapers, investing in a formerly competitive medium, like television. Own-

<sup>21</sup>Charles Mason, “MFJ Resolution Introduced in Senate,” *Telephony*, May 15, 1989, p.16.

<sup>22</sup>CC Docket No. 87.266. In July 1988, the FCC announced that the restrictions contained in the 1984 Cable Act may no longer serve the public interest, and requested public comments on a number of proposals that include cost allocations, accounting procedures, and other financial safeguards telephone companies should have to adhere to in order to be allowed into the cable business. See, for a discussion, Jeannine Aversa, “No Surprises in FCC’s Cross-Ownership Repeal,” *Multichannel News*, Sept. 26, 1988, p. 3.

<sup>23</sup>Hal Vogel of Merrill Lynch, as cited in “Gulf f+Western Sets Its Sights on Media Empire,” *Broadcasting*, Apr. 17, 1989, P. 31.

ership in every major medium now includes investors from other media—owners of newspapers, magazines, broadcasting, cable systems, books and movies mixed together. In the past, each medium used to act like a watchdog over the behavior of its competing media . . . But now the watchdogs have been cross-bred into an amiable hybrid, with seldom an embarrassing bark.<sup>24</sup>

**Also** seeking to benefit from these emerging economies are the regulated telephone companies that have been dogged in their efforts to extricate themselves from the line-of-business restrictions established by MFJ. Similarly, companies that have previously been involved primarily in data communication are now increasingly forming alliances, establishing joint ventures, and acquiring companies that will enable them to enter into new and complementary markets in the area of telecommunication .25

A number of economic factors have also fostered greater concentration and integration within communication industries, as described in chapter 3. In the area of mass media, for example, many companies--faced with rising production costs and a fragmented and more sophisticated viewing audience--are trying to spread their costs and share their economic risks by entering into mergers, alliances, and other such combinations.<sup>26</sup> Commenting on the problems faced in this environment by the small, independent company, Rich Colbert, vice-president and director of programming for Television Program Enterprises, explains:

If you are not studio-based, well-capitalized and/or associated with a broadcast group, then the odds are overwhelmingly stacked against you.<sup>27</sup>

<sup>24</sup>Bagdikian, op. cit., footnote 3, p.5.

<sup>25</sup>For some examples, see Steven Titch, "AT&T in Fiber pact," *CommunicationsWeek*, Jan. 2, 1989, p. 8; Timothy Haight, "IBM Buys Into Fiber Company," *CommunicationsWeek*, Jan. 16, 1989, p. 20; "As the Big Get Bigger the Small May Disappear," *Business Week*, Jan. 12, 1987, p. 90; Peter Purton, "Olivetti Expands Into Telephones," *Telephony*, Mar. 6, 1989; Paul Korzeniowski, "NET, Tellabs Pair Up," *CommunicationsWeek*, Apr. 17, 1989, p. 1; Timothy Haight and Glenn Abel, "HP Plans Apollo Buy," *CommunicationsWeek*, Apr. 17, 1989, p. 1; John Burgess, "IBM Ready to Enter Field of 'Caller ID' Phone System," *The Washington Post*, May 2, 1989, p. E-1; and Timothy Haight, "Novell Alliances to Extend LAN Reach," *CommunicationsWeek*, Mar. 6, 1989, p. 1.

<sup>26</sup>See ch. 3 for a discussion. See also Jay G. Bumer, "The Role of Public Policy in the New Television Marketplace," Benton Foundation *Project on Communications & Information Policy Options* (1989), paper no. 1, pp. 15-26; and Neal Koch, "Shifting Sands," *Channels/Field Guide*, 1989, pp. 84-85.

<sup>27</sup>John Flinn, "Reality Sets In," *Channels/Field Guide*, 1989, p. 87.

<sup>28</sup>Koch, op. cit., footnote 26, pp. 84-85.

<sup>29</sup>"Hostetter on Continental: Reflections on the Past, Glimpsing the Future," *Cablevision*, Apr. 24, 1989, P. 80.

<sup>30</sup>For one discussion, see "Time, Inc. and Warner Communications: Media Giants Strike Merger Deal," *Broadcasting*, Mar. 13, 1989, p. 28.

<sup>31</sup>Vogel, op. cit., footnote \*3.

<sup>32</sup>For a discussion, see Laura Landro and Dennis Kneale, "Entertainment Giants Are Now All the Rage: But Is Big Any Better?" *The Wall Street Journal*, June 9, 1989, p. 1. See also "Paramount Muddies Waters With Time Offer," *Broadcasting*, June 12, 1989, pp. 27-28.

<sup>33</sup>See Kelly Jackson, "Alliances: Goal Is One-Stop Shops," *Computerworld*, Feb. 20, 1989, P. 22.

Given this context, it is not surprising that some members of the industry estimate that over the next 4 or 5 years, the number of industry program suppliers could be reduced to four or five.<sup>28</sup> At the same time, leaders in the cable industry suggest that, over the next 25 years, the number of cable companies may decline to between six and eight.<sup>29</sup>

Most representative of the move towards greater consolidation in the media is the recently proposed merger between Time Inc. and Warner Communication, which would give rise to the world's largest media and entertainment company, as can be seen from figure 9-3.<sup>30</sup> Also indicative is the recent decision by Gulf+Western to sell its financial services subsidiary, Associates First Capital Corp. (the Nation's third largest independent finance company), in order to raise the capital necessary to continue the expansion of its communication operations on a worldwide basis.<sup>31</sup> Ironically, now renamed and reorganized as Paramount Communications, Gulf+ Western has sought to use the money garnered from the sale to compete with Warner Communications for the purchase of Time Inc.<sup>32</sup>

In the areas of telecommunication and data-processing, much of the incentive for integration comes from the post-divestiture shakeout and from users who, building enterprise-wide networks, are looking for a single source to link their disparate computing systems.<sup>33</sup> As one industry observer has described the situation:

[Users] are driving a new wave of merger mania. Strident demands for simple solutions to complex networking needs—beyond the scope of most individual companies—have spawned a wave of merg-

Figure 9-3-1988 Product, Revenue Breakdowns for Time and Warner

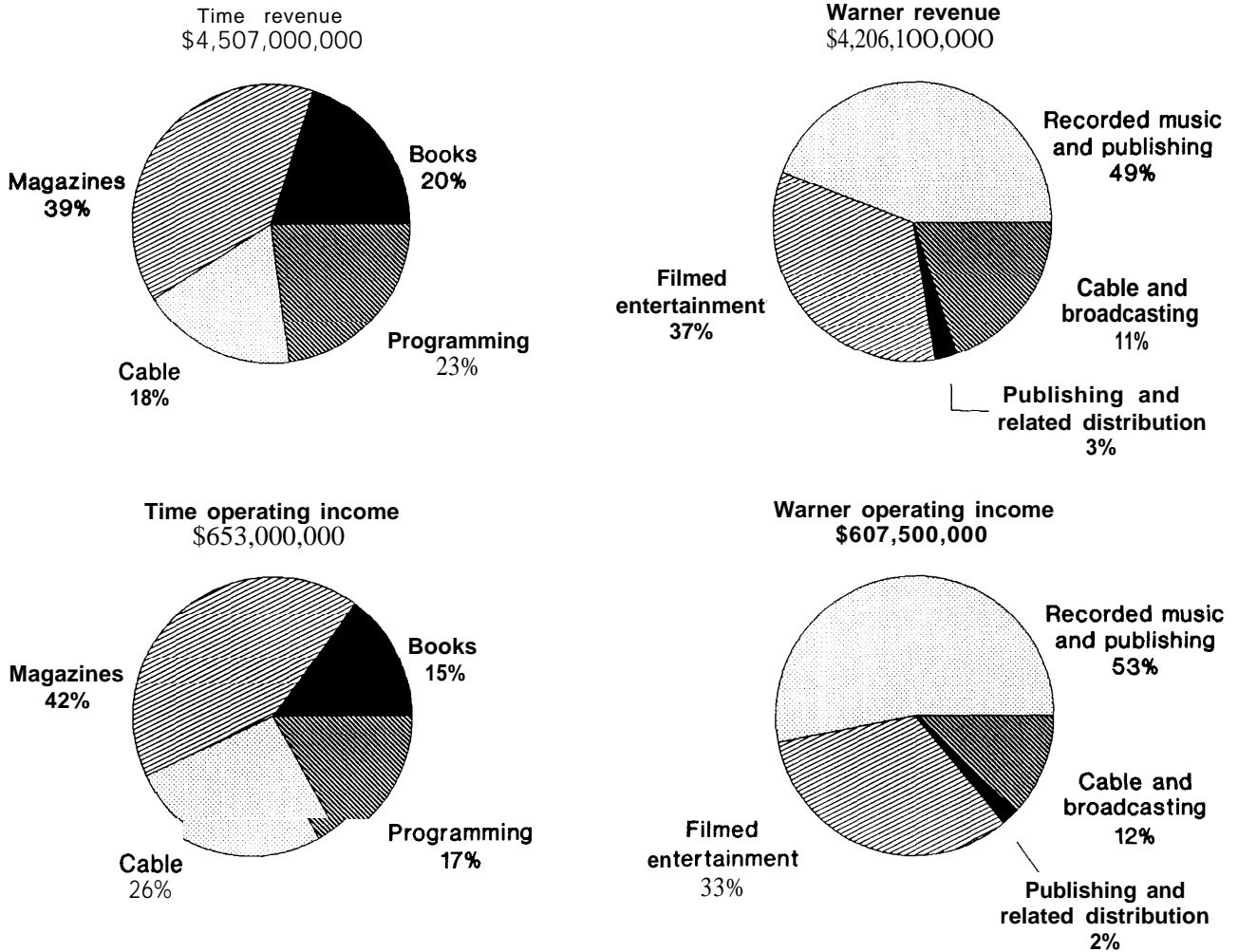

SOURCE: *Broadcasting*, Mar. 13, 1989, p. 29. Reprinted with permission.

ers, acquisitions, and business alliances over the past 2 years during which networking has really taken off.<sup>34</sup>

This move towards partnerships and consolidations can be seen most clearly by looking at the local area network (LAN) industry, which illustrates the pattern of many new players in the communication industry. Triggered by the growth of computer

networking, there was a large number of independent LAN companies in the early 1980s, competing with one another. More recently, however, as the product has become less distinct and as users have begun to look for simpler networking solutions, growth in the LAN market has begun to slow and companies have begun to coalesce, so that each of the original LAN providers has made at least one acquisition. Some of the largest and most strategic of

<sup>34</sup>Candice Wilde, "Analysts Hot on Networking," *CommunicationsWeek*, May 22, 1989, pp. 75, 88. Mergers attract money from the financial community, which in turn spurs on mergers. As the author notes: "This [development] broadens the scope of possible financial deals that could fuel stock price gains—and of course, whenever an industry starts down the acquisition trail savvy investors should follow track," *Ibid.*, p. 88.

**Table 9-3--Strategic Advantages of Recent Developments in the LAN Industry**

Companies	Type of agreement	Strategic advantage
Tandem/Ungermann-Bass . . . . .	Acquired	Broadens Tandem's transactional processing line to include LAN connectivity for distributed customer environments. As a result of owning Ungermann-Bass, Tandem will also get access to direct sales accounts based on IBM and DEC environments.
3Com/Bridge . . . . .	Merged	Makes 3Com the largest independent manufacturer of LANs, offering both low-end cluster LANs and high-performance facility-wide LANs.
3Com/Microsoft . . . . .	Joint software and R&D agreement	Poses a potential threat to Novell, the leader in LAN software. Will develop network management software for the OS/2 LM, offering a variety of advanced features.
Microsoft/Ashton-Tate	Joint marketing and R&D agreement	Will develop a relational data base server software product. Directly attacks the established position of strong stand-alone desktop computer data base vendors such as Oracle.
Digital Equipment/Apple Computer . . . . .	Joint marketing and R&D	Will enhance the development of third-party connectivity products between Macintosh workstations and the VAX environment. Bolsters a weakness in both companies.

SOURCE: *Telecommunications*, October 1988, p.24. Reproduced by special permission of *Telecommunications*.

these partnerships and arrangements are listed in table 9-3.<sup>35</sup>

These trends toward greater concentration may lead to greater discrepancies in the ability of people to access key audiences and the most strategic communication pathways. Although the total number of media pathways is generally increasing, those that offer the most effective and efficient services seem to be coming under the control of fewer communication and information gatekeepers. As ownership of the most cost-effective media becomes more and more concentrated, the ability of such owners to structure the Nation's political agenda is likely to increase. Similarly, corporate owners will assert more control over cultural and economic agendas as well.<sup>36</sup>

#### **Factor 4: Luck of clarity about coverage of first-amendment rights.**

The purposes of the first-amendment rights of free speech and free press are to prohibit the government from interfering in communication and to ensure that free and robust discussion, especially of public affairs, takes place.<sup>37</sup> First-amendment rights are not absolute, but are balanced against other competing public values, such as national security, fair trial, and public morality. Confusion (some would say incon-

sistencies) in the development of first-amendment protections has been magnified with the introduction of new forms of communication. For example, print, common carrier, and broadcast media have each been accorded a different first-amendment status.<sup>38</sup>

One technology that has recently provoked a certain amount of discrepancy and disagreement about first-amendment rights is cable television. In a court in Oakland, CA, for example, the case was successfully made that cable television is entitled to essentially the same rights as the print media, and that, therefore, cable applicants could not be denied a franchise even if a city was already receiving cable service. Based on this argument, U.S. district court judges in Palo Alto and Santa Barbara, CA, went even further to argue that, given cable's first-amendment rights, most franchise requirements were unconstitutional. However, in the case *Preferred Communication v. City of Los Angeles*, the Supreme Court remanded the case back to the district, pointing out that while cable television activities implicate first-amendment interests, where a cable system's "speech and action are joined in a single course of action," first-amendment values "must be balanced against societal interests."<sup>39</sup> And the underlying question of the proper standards for

<sup>35</sup>Timothy Haight, "Vendors: Mergers Mark the Industry Midlife," *CommunicationsWeek*, Apr. 3, 1989, pp. 1, 46; see also Martin Pyykkonen, "Local Area Network Industry Trends," *Computerworld*, October 1988, pp. 21-29.

<sup>36</sup>For for one analysis of this phenomenon, see Bagdikian, op. cit., footnote 3.

<sup>37</sup>For a discussion of the positive and negative purposes of the first amendment, see Stephen Holmes, "Liberal Constraints on Private power?" Judith Lichtenberg, *Democracy and the Mass Media* (forthcoming).

<sup>38</sup>Thiel de Sola Pool, *Technologies of Freedom* (Cambridge, MA: The Belknap Press of Harvard University Press, 1983).

<sup>39</sup>"Of Cable and Courts, Franchising and the First," *Broadcasting*, May 22, 1989, pp. 69-71.



judging first-amendment challenges was left unresolved.<sup>40</sup>

In situations such as these, where much is left to interpretation, all actors in the communication process can assert first-amendment protection, and their claims will quite often be in conflict. For example, some claim that the first amendment enables them to access any communication path for which speakers can pay.<sup>41</sup> The Supreme Court, meanwhile, has held that the first amendment protects the right of providers of some communication paths to refuse to accept paid editorials on controversial issues.<sup>42</sup> At the same time, it has held that the first-amendment right of listeners to have access to balanced presentations on issues of public importance needs to be taken into account.<sup>43</sup> Where conflicts arise, the courts have attempted to balance the first-amendment claims. Such resolution, however, depends on the particular circumstances presented in the case. As circumstances and litigants change, so may a court's interpretation of first-amendment rights. Additionally, interpretations may vary from court to court and from judge to judge.

Confusion about what is covered under the first amendment allows parties to assert first-amendment protection for a variety of interests. One member of Congress noted that as technology increases the number of people who can legitimately claim first-amendment protection, there are attempts "to try and wrap any economic desire these entities have in a First Amendment cloak in order to give a false superiority to an argument."<sup>44</sup> For example, newspaper publishers argued that the first amendment requires that telephone companies be prohibited from delivering their own electronic information services, and the court accepted this argument, at least for the short term.<sup>45</sup> In the political arena, contributors to political campaigns have argued that government ceilings on campaign contributions restrict their freedom of "political speech."<sup>46</sup>

***Factor 5: Lack of consensus on the part of decisionmakers about what constitutes the minimum level of communication services that should be made universally available.***

Recognizing the importance of communication services to everyday living, Congress incorporated the goal of universal telephone and radio service at an "affordable" cost into the Communications Act of 1934. This goal was reinforced in 1949 with the enactment of legislation to subsidize the extension of service to rural areas. Moreover, the goal of universal service has always received widespread, if not universal, support.

Notwithstanding this historical consensus, two major questions have emerged with respect to the goal of universal service—which services should be made universally available in an era when information has become a key, strategic resource; and how should the goal of universal service best be implemented.

### ***Defining Universal Service***

Now that achieving the historical goal of universal telephone and broadcasting service has been closely approximated, many suggest that universal service needs to be redefined to take into account new communication opportunities and a changing information environment. In the socioeconomic context of 1934, when the Communications Act was passed, access to telephone and radio services was considered to be extremely important. Similarly, it is necessary to determine which communication services might be considered critical in today's environment.<sup>47</sup>

In its analysis, OTA sought to provide a basis for answering this question by identifying the factors (in

<sup>40</sup>Ibid.

<sup>41</sup>Jerome Barron, "Access to the Press—A First Amendment Right," *Harvard Law Review*, vol. 80, 1967, p. 1641.

<sup>42</sup>*Columbia Broadcasting System v. Democratic National Committee*, 412 U.S. 94 (1973).

<sup>43</sup>*Red Lion Broadcasting Co. v. FCC*, 395 U.S. 367 (1969).

<sup>44</sup>Rep. Al Swift (D-Wash), as quoted in "First Amendment Spotlighted," *Broadcasting*, Nov. 16, 1987.

<sup>45</sup>See *United States v. American Telephone & Telegraph Co.*, 552 F.Supp. 131, 186 (D.D.C. 1982), aff'd sum nom; and *Maryland v. United States*, 460 U.S. 1001 (1983). See also Richard E. Wiley, "Report on Legal Developments in Electronic Publishing," *Jurimetrics Journal*, Summer 1987, pp. 403-422.

<sup>46</sup>*Buckley v. Valeo*, 424 U.S. 1 (1976).

<sup>47</sup>For one example, see "The Intelligent Network Task Force Report," Pacific Bell, October 1987; and *NTIA Telecom 2000*, op. cit., footnote 19.

addition to cost) that prevent people from taking advantage of opportunities that new communication technologies afford. The two most important factors OTA identified are technological skills and access to navigational tools.<sup>48</sup>

### Technological Skills

To both communicate and use information effectively, one needs to have certain technical skills. In any particular instance, the kinds of skills required are relative to the social and technological environment in which people live and work. Given that many of the transaction costs entailed in communicating are greater and will increasingly be borne by the user, it is likely that people will need to be much more technically sophisticated in order to communicate and use information to their best advantage. Moreover, achieving this kind of sophistication is complicated by the fact that a considerable number of Americans cannot even read and write well enough to be able to act effectively in their daily lives. Although policies addressing literacy have not generally been considered in communication decisionmaking, this study highlights their relevance. At the very least, this requirement for literacy needs to be taken into account in defining what will constitute universal service in the future.

### Navigational Tools

Navigational tools guide users through the maze of information, enabling them to identify and locate relevant information and communication paths. Including such things as computer menus, TV guides, and telephone directories, navigational tools are the means by which individuals and groups interact with their communication and information environment and discover the options available. In some cases, navigational tools can help to compensate for a user's lack of technological sophistication. For some people, the fact that navigational tools are not widely available represents a significant barrier to their ability to access information. Like techno-

logical skills, this factor needs to be taken into account when defining universal service for the future.<sup>49</sup>

### Implementing Universal Service

A second major question that has emerged with respect to universal service--given some agreement on what should constitute it--is how it should best be provided, priced, and paid for. Some contend, for example, that there are major economies of scale and scope in providing communication services. Hence, they believe that universal service can be provided most efficiently on a monopoly basis, with rate regulation and some form of subsidization. In contrast, others assert that economies in the communication infrastructure are insufficient to justify monopoly services. They argue that universal service can be achieved most efficiently if all communication providers, being allowed and encouraged to compete in the marketplace, are induced to lower their prices. To assure equitable access, these advocates would provide subsidies targeted to those who could not afford service under such an arrangement.

This issue is compounded by the uncertainties and lack of agreement about the nature of economic relationships within the communication infrastructure.<sup>50</sup> Some stakeholders see these relationships as sufficiently competitive; others do not. Reaching a consensus is likely to be even more difficult in the future, given a rapidly changing technological environment with increasing amounts of horizontal and vertical integration.<sup>51</sup> Even in determining how best to implement universal service, decisions will be subjectively based to some extent.

## STRATEGIES AND OPTIONS

If Congress wishes to affect access to communication services, it could pursue a number of different strategies. Congress could:

<sup>48</sup>In the final analysis, however, the answer to the question of what should constitute universal service is inherently, and profoundly, a political as well as a philosophical one. Given the enhanced role of information and communication in the economy and society, access to communication services is now an important determinant of all socioeconomic opportunities. Thus, making choices about universal service is essentially making choices about equality of opportunity. Defining universal service is, in effect, making choices about the nature of society itself.

<sup>49</sup>Some have noted, moreover, that the need for universal access to navigational tools should apply not only to users of information, but to providers of information as well. Just as users need tools to help them locate information appropriate to their needs, so information providers require tools to help them identify the most appropriate audiences. Some fear that, in the future, the providers of navigational tools may serve as a new bottleneck to competition. Access to users has already become a policy issue in the case of telephone companies' control of customer proprietary network information (CPNI). It is important to note that policies that enhance access to users can have significant privacy implications.

<sup>50</sup>For a discussion, see ch. 3.

<sup>51</sup>Ibid.

- influence the means by which communication services are funded and financed,
- structure the prices at which such services are offered,
- provide direct government support for users to access information and communication paths,
- regulate and/or redefine the rights of media-owners,
- influence the level and availability of the tools and resources required to access communication and information services, and
- assume a more proactive role to assure robust debate on issues of public importance.

A discussion of these strategies, and options for achieving them, follows. A summary appears in figure 9-4.

### **Strategy 1: Influence the means by which communication services are funded and financed.**

*Option A: Reconsider policies for funding and providing financial support for noncommercial media.*

In the United States, there has been a long history of funding media services. As described in chapter 4, in addition to subsidizing the postal service and the press and supporting public education, the Federal Government has also fostered and provided financial support for scientific research and the arts. For example, Congress supported the development of a national library system, passing legislation in 1895 to make the vast store of government publications available to the public through a network of national depository libraries.<sup>52</sup> In addition, the Federal Government has provided financial support for the National Endowment for the Arts and the National Endowment for the Humanities, as well as for the production and distribution of educational and cultural television programming through the Corporation for Public Broadcasting (CPB) and direct funding of public broadcast stations.<sup>53</sup>

A number of different rationales have, over time, served to encourage government funding of this kind. Subsidies have been provided, for example, to foster an informed and educated citizenry, to develop national manpower, to provide equity, and to broaden and enhance cultural experiences. Support has also been provided to encourage the production of public goods (such as research and education) which, given their particular economic nature, are generally produced in short supply. However, considering the special role that communication plays in political affairs, the question of how government should involve itself in this area has always been highly sensitive and potentially controversial, as the following example and discussion of public broadcasting serves to illustrate.

In the United States, public broadcasting has traditionally received funding from a number of different sources-Federal, State, and local governments; individual subscribers; businesses; foundations; and universities, as can be seen from table 9-4. As detailed by John Carey:

In 1987, the estimated total income for public broadcasting from all sources was 1.29 billion dollars. Federal sources provided 18.8 percent of all income, while non-federal sources provided 81.2 percent of income. Total income from federal sources has increased moderately during the last decade. However, income from federal sources has declined, as a percentage of all income, while income from members and businesses has increased.<sup>54</sup>

Given the ad hoc nature of these sources, there has always been some concern about the long-term viability of funding for public broadcasting. However, since 1983, Federal funding for public radio and television has increasingly become a subject of

<sup>52</sup>Joe Forehead, *Introduction to United States Public Documents 58-59* (Littleton, CO: Libraries Unlimited, 2d edition, 1978). See also U.S. Congress, Office of Technology Assessment, *Informing the Nation: Federal Information Dissemination in an Electronic Age*, OTA-CIT-396 (Washington, DC: U.S. Government Printing Office, October 1988). In 1987, the Federal Government spent \$6 billion distributing about 58,000 publications to more than 1,300 depository libraries.

<sup>53</sup>See William Baumol, *Performing Arts* (New York, NY: Twentieth Century Fund, 1966); and William Baumol, *in..atiort and the Performing Arts* (New York, NY: New York University Press, 1982). In 1987, the Federal Government contributed 18.8 percent of the \$1.29 billion in funding collected for public broadcasting. See John Carey, "Public Broadcasting and Federal Policy," Markle Foundation, *New Directions in Telecommunications Policy*, vol. 1, *Regulatory Policy: Telephony and Mass Media* (Durham, NC: Duke University Press, June 1989); and Michael Rice, *Public Television.. Issues of Purpose and Governance* (New York, NY: Aspen Institute, 1981).

<sup>54</sup>Carey, op. cit., footnote 53.

**Figure 9-4--Congressional Strategies and Options To Address Access to CommunicationS Opportunities**

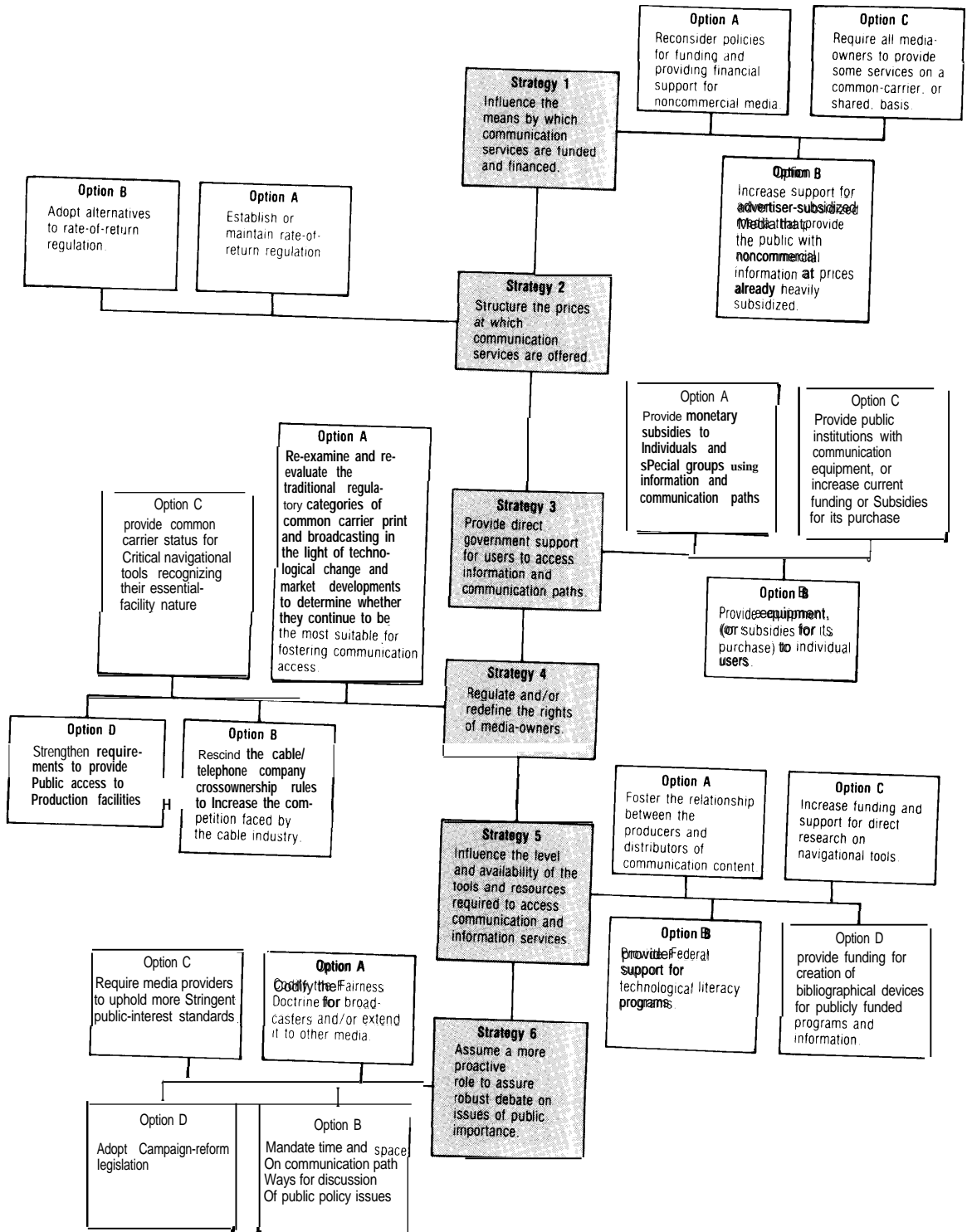

**Table 9-4--Sources of Public Broadcasting Income, 1987 (Total estimated income= \$1.29 billion)**

Source	Percentage of all income
Federal Government . . . . .	18.8
State and local government, colleges and universities. . . . .	32.8
Member donations and auctions . . . . .	23.0
Business and industry . . . . .	15.1
Foundations . . . . .	3.7
Other . . . . .	6.6

SOURCE: Corp. for Public Broadcasting

congressional controversy and public debate.<sup>55</sup> Questioning whether it is appropriate for tax dollars to be used to support the tastes of one segment of the American audience, some have urged that congressional appropriations be replaced by private and voluntary revenue sources.<sup>56</sup> On the other hand, some critics have suggested that public broadcasting is beginning to stray from its original goal of providing alternative, and controversial, programming because of its increased dependence on industry and foundations for financial support.<sup>57</sup>

Differences have also arisen with respect to how, and to which groups, Federal monies should be channeled and allocated. For example, concerned that CPB was allowing its programming decisions to be guided too much by political considerations, the

Senate Committee on Commerce, Science, and Transportation included language in one version of the funding bill for public broadcasting that called for the direction of funds to local broadcast stations rather than to CPB. Opponents of this idea, among them CPB, argued that such a plan would threaten the quality of public television's programming, undermining minority programming and speeding up the creeping commercialization of the product.<sup>58</sup> As passed, Public Law 100-626 ordered CPB to undertake, and provide to Congress by January 1990, a study of the funding process.<sup>59</sup>

This problem of finding public media may become more acute in the future. Not only have the costs of production increased significantly, but competition for subscriber and production funds has also increased from pay channels offering cultural and other programming targeted to the traditional public television audience.

Over the years, a number of alternative methods of financing public broadcasting have been proposed. These include:

- . a manufacturer's excise tax on television sets;<sup>60</sup>
- . a cultural subscription television service;<sup>61</sup>
- . advertisement-based public television services;<sup>62</sup>

<sup>55</sup>For a discussion, see **Bernevia McCalip**, "public Broadcasting Funding: The Process and Current Issues," Library Of Congress, **Congressional Research Service**, #HE 6645 D, Apr. 22, 1986. See also Harry M. **Shooshan III** and **Louise Arnheim**, "Public Broadcasting," Benton Foundation **Project on Communications & Information Policy Options**, paper no. 2, 1989.

<sup>56</sup>**McCalip**, *op. cit.* footnote 55, p. 1.

<sup>57</sup>For a general discussion of the failure of public television to meet its original goals, see **Stephen White**, "Our Public Television Experiment," *Current*, Oct. 20, 1987, pp. 7, 10-11. For a discussion of why labor issues are rarely aired on public television, see **Pat Auferheide**, "The Corporatization of Public TV," *Union*, October/November 1988, pp. 11-13.

<sup>58</sup>See, for a discussion, "Public Broadcasting Dispute Eased," *Congressional Quarterly*, Oct. 15, 1988, p. 2986. See also "Dissent in Public Broadcasting: Who Controls the Purse Strings?" *Broadcasting*, May 30, 1988, p. 25.

<sup>59</sup>This issue is presently under study by two groups, the 30-member **National Association of Public Television Stations (NAPTS) Task Force** (which includes representatives from PBS, NAPTS, CPB, individual stations, regional, and minority groups), and by **CPB**. CPB is responsible for delivering the congressional report. How, and to what extent, it will integrate the comments of the Task Force into its report is still unclear. For a discussion, see "Public TV Reviews Budget Plans," *Broadcasting*, Feb. 13, 1989, pp. 89-91. Public Law 100-626 also created a fund to be distributed to independent producers and production entities, producers of national children's educational programming, and producers of programming addressing the needs and interests of minorities for the production of programs. CPB was also called on to create an independent production service, which would be exclusively dedicated to supporting a number of demonstration projects towards greater broadcast diversity.

<sup>60</sup>In its 1977 report on public television, the Carnegie Commission recommended that Congress employ a manufacturer's excise tax on television sets (beginning at 2 percent and rising to a ceiling of 5 percent) to fund public television. This approach was followed by most European countries. However, Congress was strongly opposed to it. **Stephen White**, "Our Public Television," *The Public Interest*, Summer 1987, pp. 85-86. More recently, as an alternative to S.1935, the National Association of Broadcasters proposed that a public broadcasting support fee be collected by imposing a 1.5- to 2-percent tax on TV-VCR-radio sets, but the Electronic Industries Association strongly opposed that plan. *Television Digest*, Nov. 9, 1987, p. 1.

<sup>61</sup>In 1981, **Larry Grossman**, President of PBS, circulated a plan for the Public Subscriber Network, a cultural subscription-TV service that public broadcasters would use to air first-run public TV programs, but "PBS Cable" never got under way. **Richard Barbieri**, "Do Home Shopping and 'NewsHour' Belong on the Same Channel?" *Current*, May 19, 1987, p. 1.

<sup>62</sup>The **Temporary Commission on Alternative Financing for Public Telecommunications**, created by Congress in 1981, recommended that Congress permit "enhanced underwriting," but not traditional systemwide advertising. For a discussion, see Subcommittee on Telecommunications, Consumer Protection, and Finance, of the House Committee on Energy and Commerce, 97th Cong. 2d sess., *Alternative Financing Options for Public Broadcasting: Report of the Temporary Commission on Alternative Financing for Public Telecommunications*, committee print, 1982.

- the establishment of a trust fund in support of public television, using fees from the sale or lease of spectrum;<sup>63</sup> and
- a trust fund using taxes on license transfers for radio and broadcast stations.<sup>64</sup>

Although none of these proposals has generated widespread support, they may have greater appeal in the future, given government budget deficits and continued financial constraints in public broadcasting.

The history of public broadcasting serves to illustrate some of the difficulties and the kind of opposition that might arise if Congress were to adopt a similar direct-funding approach to foster the development and use of other electronic media and communication services.

*Option B: Increase support for advertiser-subsidized media that provide the public with noncommercial information at prices already heavily subsidized.*

With the growth of fee-based communication services, Congress might take steps to promote and/or protect media that are supported or subsidized by advertising. Congress has provided this kind of support for advertisement-based media in the past, for example, by limiting the markets in which cable services could compete with broadcasting services, and by establishing “must-carry rules” that required cable companies to carry local broadcast signals.<sup>65</sup> Such support was later rescinded, however, with deregulation of the cable industry in 1984, and as a result of the Supreme Court’s decision to invalidate the must-carry rules.

Today, however, the cable industry is no longer an infant industry struggling for survival. In fact, as

already noted and discussed below, the concern now is with the pace of integration and concentration in the cable industry.<sup>66</sup> Moreover, broadcasters, faced with the fragmentation of their market and a loss in advertising share, are no longer as dominant in the media industry.

In this changed context, there is once again a call to provide greater support to advertiser-based media services. While many media providers would welcome such support, some would want to minimize any public-interest obligations they might incur in exchange for government promotion.<sup>67</sup> On the other hand, such policies are not likely to be supported by fee-based media providers who are benefiting from the shift to their services. Consumers might also take issue with such policies if they were to deprive them of the choice of paying for advertisement-free entertainment, or if they led to price increases. Any congressional action in this regard would depend on the importance Congress places on the public having some common means for accessing communication content, an issue discussed in more detail in chapter 7.

One way in which Congress might act to support advertiser-based media is to reinstate “must-carry” requirements. A case for such action has been strongly put forward by the FCC Commissioner, James Quello. As he has stated:

Congress should do this not to please broadcasters, but to serve the public with assured free TV .. .<sup>68</sup>

One problem with adopting must-carry rules is that their constitutional status has yet to be determined. The Supreme Court invalidated previous “must-carry” rules in July 1985 on the grounds that they infringed on the first-amendment rights of cable

<sup>63</sup>This method, which has been supported by a number of free-market economists, was included as part of a 1987 administration budget proposal.

<sup>64</sup>S. 1935 proposed to fund a public broadcasting trust fund with a 2-percent fee on the transfer of any license administered by the FCC, with an additional 2-percent fee due on radio and TV stations transferred less than 3 years after previous sale, and an additional 1-percent fee for transfers of licenses by those found to have “willfully” violated the Fairness Doctrine. The fee would have been based on the price paid or fair market value of the license involved, including the value of all assets used in connection with that license.

<sup>65</sup>In 1968, for example, the FCC set up rules that governed the operation and delivery of subscription television services and over-the-air transmissions of pay TV programming that prohibited these services from competing with broadcasters for recent sporting events or feature films that were between 3 and 7 years old. Challenged in the courts by Home Box Office (HBO), these rules were eventually overturned. For a discussion of the history of cable regulation, see Don R. Le Duc, *Cable Television and the FCC* (Philadelphia, PA: Temple University Press, 1973); see also Don R. Le Duc, *Beyond Broadcasting: Patterns in Policy and Law* (New York and London: Longman, 1987); and Tom Whiteside, “Onward and Upward with the Arts,” *The New Yorker*, part 1 May 20, 1985; part 2 May 27, 1985; and part 3 June 3, 1985.

<sup>66</sup>See, for one recent discussion, Harry M. Shooshan III, “Cable Television: promoting a Competitive Industry Structure,” Paula R. Newberg (ed.), *New Directions in Telecommunications Policy*, vol. 1, *Regulatory Policy: Telephony and Mass Media* (Durham, NC: Duke University Press, June 1989), pp. 222-246.

<sup>67</sup>See “INTV’s Padden Says Broadcasters Must Embrace Public Interest Standard,” *Broadcasting*, June 27, 1988, pp. 52-53.

<sup>68</sup>James Quello, “Must Carry From A Commissioner’s Point of View,” *Broadcasting*, May 28, 1988, p. 28.

owners.<sup>69</sup> The courts reiterated this position in 1987 when the FCC sought to introduce a new set of must-carry rules.<sup>70</sup> However, the court made it clear that they did not “mean to intimate that the FCC may not regulate the cable industry so as to advance substantial governmental interests.”<sup>71</sup> Thus, the Court left the door open for Congress to make a stronger case of demonstrating that such rules would serve a “substantial government interest.”<sup>72</sup>

Industry stakeholders disagree about what effect the elimination of must-carry rules has had on the availability of local broadcast programming, and thus about the need for new laws. Cable companies claim that only the marginal, unprofitable stations are being dropped from cable distribution.<sup>73</sup> While staunch in advocating their rights under the first amendment, representatives of the cable industry have, however, demonstrated a willingness to compromise in this area.<sup>74</sup> Broadcasters strongly urge the reimposition of must-carry rules. They claim that cable companies have dropped a significant amount of broadcasters’ programming, not because these programs were failing, but because they were too successful and too competitive with cable.<sup>75</sup> Data on this issue were collected in surveys by the FCC and submitted to Congress in 1988.<sup>76</sup>

Decisions about must-carry are further complicated because they are linked to other media policy decisions. Some influential members of Congress, for example, have pointed out that they will not give positive consideration to new must-carry legislation until the issue of the Fairness Doctrine, as discussed below, has been resolved. Others have tied the issue of must-carry to that of the cable compulsory license.<sup>77</sup>

Another way in which Congress might affect the future of advertiser-based broadcasting is through its decisions about high definition TV (HDTV). Recognizing that, if broadcasters are to remain competitive with other media, they will need to be timely in delivering a high-quality HDTV product, the FCC favored the domestic broadcasting industry with its September 1988 decision requiring that HDTV standards be compatible with existing television sets.<sup>78</sup> At the same time, the FCC declined to provide the additional spectrum that broadcasters would need to develop some HDTV options, such as the MUSE system proposed by the Japanese.<sup>79</sup>

*Option C: Require all media owners to provide some services on a common-carrier, or shared, basis.*

The law of common carriage as it pertains to telecommunication was modeled after railroad legis-

<sup>69</sup>*Quincy Cable TV, inc. v. FCC*, 768 (D.C. Cir. 1985), cert. denied 106 S. CT 2889 (1986).

<sup>70</sup>In accordance with a compromise struck between major cable and broadcast interests, the FCC issued interim must-carry rules in 1986 and 1987. These rules required large cable systems to make a limited portion of their capacity (up to 25 percent) available to local TV signals, and all cable systems to offer subscribers A/B switches, which allow viewers to switch from cable to antenna reception. See Henry Geller, “Broadcasting,” Markle Foundation, *New Directions in Telecommunications Policy, vol. 1, Regulatory Policy: Telephony and Mass Media* (Durham, NC: Duke University Press, June 1989).

<sup>71</sup>*Century Communications COW. v. FCC*, 835 F. 2d 292 (C/C/ Cior.), cert denied 56 U.S. L.W. 3816 (May 31, 1988).

<sup>72</sup>By basing its ruling on the failure of the must-carry rules to meet the U.S. Supreme Court’s *O’Brien* test, the court avoided the more general and problematic question of what kind of first-amendment protection should apply to cable. John Wolfe, “Appeals Court Again Invalidates Must-Carry on Free Speech Grounds,” *Cablevision*, Dec. 21, 1987, p. 12.

<sup>73</sup>For example, a Price Waterhouse survey, commissioned by NCTA, found that cable systems continue to carry 98 Percent of the broadcast stations qualified to be carried under the second set of must-carry rules, that 94 percent of cable systems carry all the local broadcast signals that were required under those rules, and that 91 percent of operators have not repositioned the broadcast stations. “NCTA Study Shows Cable Carrying Most Stations,” *Broadcasting*, Sept. 19, 1988, p. 59.

<sup>74</sup>For example, the National Association of Broadcasters and the National Cable Television Association are presently trying to negotiate a must-carry agreement between them. See “Must Carry Law Germinating in Congress May Not Survive, Predicts Attorney,” *Broadcasting*, Jan. 30, 1989, p. 60.

<sup>75</sup>For an account by the Association of Independent Television Stations, Inc., see *Free Television Under Siege: Typical and Illustrative Case Histories of Anti-Competitive Conduct by Cable Television Systems*, submitted to the Congress of the United States and the Federal Communications Commission, May 1988.

<sup>76</sup>Larry Jaffee, “Must-Carry Report Earns Split Decision,” *Multichannel News*, Sept. 5, 1988, pp. 1, 88.

<sup>77</sup>Under the Copyright Act of 1976, cable companies have a compulsory license to carry all signals that are authorized by the FCC. In October 1988, the FCC recommended that Congress abolish this license, at least for distant signals. In January 1989, Representative John Bryant reintroduced legislation that could make the compulsory license conditional on whether or not cable operators carry local broadcast signals.

<sup>78</sup>See Norm Alster, “TV’s High Stakes, High-Tech Battle,” *Fortune*, Oct. 24, 1988, pp. 161-170; David B. Hack, “High Definition Television (?IDTV) in the United States—What Does An ‘Even Playing-Field’ Look Like?” Library of Congress, Congressional Research Service, Report 88-365 SPR, May 31, 1988.

<sup>79</sup>Advanced Television Systems, 3 FCC Rcd 6520 (1988). Broadcasters have urged the FCC not to reallocate to land mobile those parts of the UHF broadcast spectrum that might be required to develop an HDTV system. So far, the FCC has gone along with this request, although the spectrum allocation issue is still unresolved. See Geller, op. cit., footnote 70, pp. 20-21.

lation, which had been employed as a means of eliminating discriminatory or exclusionary practices. While granting the telegraph companies (and later the telephone companies) special privileges—such as the right to use public roads, to exercise the power of eminent domain, and to use the corporate form of doing business—it also imposed the obligation to provide reasonable and nondiscriminatory service to the public.<sup>80</sup> Moreover, as Ithiel de Sola Pool pointed out:

... though common carrier doctrine often lacks explicit reference to civil liberties, many of the same concerns are dealt with in different words. In its own way the law of common carriage protects ordinary citizens in their right to communicate. The traditional law of a free press rests on the assumption that paper, ink, and presses are in sufficient abundance that, if government simply keeps hands off, people will be able to express themselves freely. The law of common carriage rests on the opposite assumption that, in the absence of regulation, the carrier will have enough monopoly power to deny citizens the right to communicate.<sup>81</sup>

Unlike those who provide telephony-based services, owners of the mass media have almost complete discretion in determining the programming and content they distribute. For, as the court ruled in *Miami Herald Publishing Co., v. Tornillo*, even when a daily newspaper is the only daily in a city, the government cannot require it to provide a right-of-reply to someone criticized in its pages.<sup>82</sup> Thus, to be guaranteed access to a wide-reaching communication platform, an individual would, in extreme cases, need to purchase a cable network, newspaper, or a broadcast station. The costs of such access preclude this option for the vast majority of Americans. In

1988, for example, the average cost of buying a stand-alone television station was \$25.8 million, up \$2 million from 1987's average,<sup>83</sup> while in some markets the cost of buying a cable system was up to \$2,500 per subscriber.<sup>84</sup>

To facilitate broader access to communication paths for those who presently cannot afford it, Congress could require media owners to lease portions of their pathways in the fashion of a common carrier, in much the same way as some cable companies were once required to do with their public access facilities.<sup>85</sup> Or, as some economists have suggested, rather than granting a single broadcaster an exclusive license to use a frequency in a market for a number of years, different content producers could be given licenses to different portions of a broadcast day. In this way, the costs of access could be shared and spread over a range of pathway users.<sup>86</sup>

Policies requiring common carriage or the sharing of pathways are likely to be strongly opposed by media owners who do not want to give up discretion over the content they provide. Such discretion not only provides them a vehicle to express their own points of view; it also allows them to select the programming that will yield the greatest financial returns.<sup>87</sup> In recent years, media owners have, with the support of the courts, become increasingly successful in resisting any government efforts to influence content.

This situation might change, however. Issues involving the rules that govern information distribution are likely to persist and be reactivated as telephone companies, which have traditionally

<sup>80</sup>William K. Jones, "The Common Carrier Concept As Applied to Telecommunications: An Historical Perspective," Paper Submitted to the Federal Communications Commission as Appendix to the Reply Comments of International Business Machines Corp. in *Competitive Carriers Rulemaking*, CC Docket No. 79-252, filed Apr. 4, 1980, p. A-6.

<sup>81</sup>Pool, *op. cit.*, footnote 38, p. 106.

<sup>82</sup>*Miami Herald Publishing Co. v. Tornillo*, 41805241 (1974).

<sup>83</sup>"Changing Hands 1988," *Broadcasting*, Feb. 13, 1989, p. 46.

<sup>84</sup>"Is Cable Cornering the Market?" *The New York Times*, Business, Apr. 17, 1988, pp. 1, 12.

<sup>85</sup>The granting of some cable franchises, for example, was made contingent on a cable company's agreement to provide some access to members of the public who wish to produce information content. *Manhattan Cable TV*, for example, carries 150 hours of public-access programming per week. In exchange for access, producers agree to create a certain number of programs to fill a given time-slot. As might be imagined, the quality and variety of these programs vary considerably. For a discussion, see Lisa Belkin, "Public-Access TV: Behind the Scenes," *The New York Times*, Apr. 13, 1987, p. C-18.

<sup>86</sup>See, for example, B.M. Owen, J.H. Beebe, and W.G. Manning, *Television Economics* (Lexington, MA: Lexington Books, 197A); R. M. Peck, @J. McGowan, *Economic Aspects of Television Regulation* (Washington, DC: Brookings Institution, 1973); and Mark Nadel, "Comcar: A Marketplace Cable Television Franchise Structure," *Harvard Journal on Legislation*, vol. 20, 1983, pp. 541-578.

<sup>87</sup>As Le Duch has noted, the willingness of cable companies to provide channels for the programming of others declined as the value to be gained by doing their own programming increased. See Le Due, *op. cit.*, footnote 65.



served as common carriers, become more and more involved in the delivery of dial-up information and video services. Rethinking the role of telephone companies could usefully provide an opportunity to readdress and reassess all of the rules that govern media owners and information providers. One issue that might particularly benefit from further exploration is the relationship between content and carriage.<sup>88</sup>

### Strategy 2: Structure the prices at which communication services are offered.

#### *Option A: Establish or maintain rate-of-return regulation.*

Government has traditionally sought to assure universal access to telephone services at affordable prices by limiting market entry and by regulating the rate-of-return that telephone companies could earn on their investments. Regulation was considered necessary, given the telephone company's ability to charge monopoly prices. However, in the more competitive environment that followed divestiture, policymakers began to seek alternatives to rate-of-return regulation.

In spite of this growing interest in developing new regulatory mechanisms, there are a number of stakeholders who want to maintain rate-of-return regulation—or at least postpone any changes—until there is more evidence demonstrating their positive effects.<sup>89</sup> They claim that, at present, there is insufficient competition in the communication industry—and especially in the local exchange—to merit changes in regulatory policy.<sup>90</sup> They contend that these alternative regulatory approaches will lead to inequities and less affordable prices for communication services. Contrary to the FCC's estimates of consumer gains, for example, the International

Communication Association predicts that, if the FCC proposal to establish price caps (described below) were adopted, consumers will lose \$6.7 billion over the next 4 years.<sup>91</sup> Similarly, the Consumer Federation of America has argued that residential customers will suffer higher rather than lower rates under the FCC plan.

Many also challenge the notion that incentive-based regulations will provide incentives for greater efficiency and innovation. They suggest that these new forms of regulation will, in fact, induce carriers to reduce the quality of their services.<sup>92</sup> Moreover, some argue that, under a new system, the administrative burdens placed on the FCC will be greater than before. They question whether the FCC has sufficient staff to handle price-cap implementation. Criticizing specific aspects of the plan, some maintain that: 1) the price-cap index should not be based on present tariffs, which they claim are too high,<sup>93</sup> and 2) there is no way of figuring out what a good index would be. Others challenge the index that has been proposed to adjust for productivity increases.<sup>94</sup>

Among those who favor maintaining rate-of-return regulation are the National Association of Regulatory Utility Commissioners, the Consumer Federation of America, CompTel, MCI, the American Association of Retired Persons, and the National Association of State Utility Consumer Advocates.<sup>95</sup>

Telephony is not the only area where the regulation of rates is being called for. Concerned about concentration and integration within the cable industry, and recent hikes in rates being charged for cable service, a number of groups—among them the Consumer Federation of American and the Motion Picture Association of America (MPAA)—are now urging that the cable industry be made subject to

<sup>88</sup>At present, media owners are responsible for the content they distribute. Thus, if they were obliged to provide information services "on a common-carrier basis, determinations would need to be made about who should be held responsible for obscenity, false statements, libelous statements, etc. If accorded the same immunity from liability as telephone companies and the postal service, this could increase the dissemination of such disfavored messages as dial-a-porn.

There is also the issue of whether the underlying carrier should be permitted to carry its own messages, when such carriage might enable it to disseminate its own materials on a more favorable basis than those of its competitors. This is discussed by Judge Greene in his MFJ decision.

<sup>89</sup>Kathleen Killete, "Users U\_ FCC t. Delay Price Caps," *CommunicationsWeek*, Sept. 19, 1988. See also Charles Mason, "Some Lawmakers Want Price Caps Put on Ice," *Telephony*, July 18, 1988, p. 13.

<sup>90</sup>For one view, see Ronald J. Binz, "The Problem with Price Caps," *Telephony*, Sept. 26, 1988. See also Consumer Federation of America, "Divestiture Plus Four: Take the Money and Run," December 1987.

<sup>91</sup>Joseph W. Waz, Jr., "The Rise—and Fall?—of Price Caps," *Telematics*, vol. 5, No. 9, September 1988, pp. 8-13.

<sup>92</sup>Binz, *op. cit.*, footnote 90.

<sup>93</sup>*Ibid.*

<sup>94</sup>Charles Mason, "USTA Blasts AT&T Productivity Claim," *Telephony*, Sept. 19, 1988, pp. 11-12.

<sup>95</sup>See Further Notice in the FCC Docket 87-313 (price caps), May 1988.

increased regulation.<sup>96</sup> Moreover, following Senate Antitrust Subcommittee hearings in April 1989, Senator Howard Metzenbaum, the chairman, introduced two bills. One restored the authority of cities to regulate cable rates, and the other required cable operators to make their programming available to cable competitors such as wireless cable.<sup>97</sup>

*Option B: Adopt alternatives to rate-of-return regulation.*

As noted, many argue that rate-of-return regulation is unproductive and no longer necessary.<sup>98</sup> Advocates of this position propose that telephone companies be allowed greater leeway in setting prices and earning profits. According to this view, with the ability to gain rewards for superior performance, telephone companies will have more incentives to innovate and reduce costs. Advocates contend, moreover, that the administrative costs of such an approach would be lower than for rate-of-return regulation.

One FCC alternative to rate regulation is a system of price caps.<sup>99</sup> Under this scheme, carriers would not be restricted in the rate-of-return they earn so long as the prices they charge for service remained within a prescribed range or band. Although the FCC price-cap proposal was originally intended to apply to AT&T alone, some have argued that it should be extended to include the local exchange carriers and independent telephone companies on a voluntary 4-year basis. In accordance with the latest version, prices would be capped on the basis of existing tariffs, adjusted over time for productivity gains so that the benefits of productivity would be shared between consumers and the telephone companies alike. The FCC estimates that, if such an approach

were adopted, consumers would reap \$1.6 billion in savings within the first 4 years.

Other incentive-based regulatory approaches have been adopted or proposed in a number of States.<sup>100</sup> Vermont, for example, has adopted a social contract mechanism that allows the Vermont Public Advocate (a member of the Department of Public Service) to negotiate a 5-year contract with New England Telephone that provides for both the stabilization of local rates and the relaxation of rate-of-return regulations. In 1986, New York State began a moratorium on rate changes, to last approximately 2 years, and announced that it would allow New York Telephone to retain one-half of all revenues earned in excess of its permitted 14 percent rate-of-return. Similarly, the South Carolina Public Service Commission has applied price caps to AT&T's intrastate interLATA services since 1984.

Incentive-based regulation has the support of NTIA, as well as the basic support of AT&T and most local exchange carriers. AT&T, however, has argued that the local exchange carriers should be subject to more regulation, given the lack of competition in their industry. Supporters have called for additional fine-tuning in a few areas, such as determining how base rates are set and the productivity assumptions that are built into rates.

These regulatory proposals have been challenged by a number of stakeholders who want to maintain rate-of-return regulation. In the face of this opposition, and in response to congressional pressure, the FCC postponed making a final decision on its price-cap plan to allow more time for consideration and deliberation.<sup>101</sup> The FCC approved a revised plan for AT&T in March 1989. No decision was made with respect to RBOCs. Not entirely satisfied

<sup>96</sup>As noted by Shooshan, "the absence of effective competition in most cable markets means that cable subscribers are forced to pay more for programming than they would in a competitive market. In those few markets where competing cable systems are being built and operated, cable rates have been reduced substantially. Op. cit., footnote 66, p. 10.

<sup>97</sup>See S.833 and S.834.

<sup>98</sup>For a discussion of the issue, see Further Notice in the FCC Docket 87-313 (Price Caps), May 1988, pp. 17-34; see also Waz, Jr., op. cit., footnote 91.

<sup>99</sup>The FCC price-cap proposal was first aired in August 1987, but further revised in May 1988. The May 1988 version extended the plan to the regional Bell operating companies and independent telephone companies, and made participation voluntary for a 4-year test period beginning in April 1990. The FCC issued a 500+ paragraph notice in May 1988, requesting comments by July 26 and reply comments by August 26, 1988. The FCC was expected to approve a price-cap plan in January 1989, but delayed a decision until March 1989 to permit it to review the matter with Congress. FCC Docket 87-313, May 1988, paras. 24-56.

<sup>100</sup>See Further Notice in FCC Docket 87-313, May 1988, pp. 39-40. See also, Paul Teske, "State Regulation of Telecommunications," OTA contractor report, July 6, 1987.

<sup>101</sup>For a discussion, see Kathleen Killete, "U.S. Bill Would Bottle price Caps," *CommunicationsWeek*, Feb. 8, 1988, pp. 1, 63; John Burgess, "the FCCA Delays Decision on AT&T Rate Plan," *The Washington Post*, Jan. 21, 1989, p. C-1; and Mitch Betts, "Price Caps: A Road to Deregulation," *Computerworld*, Feb. 13, 1989, p. 59.

with the FCC's revised price-cap plan, the Chairman of the House Telecommunications Subcommittee, Edward J. Markey, together with 13 cosponsors, introduced the Telephone Rate Verification Act. According to Markey, the act is designed to be "an early warning system" that will alert the public to any "unintended consequences" of the price-cap plan. As provided by the act, the General Accounting Office would review the FCC's reports and evaluate the effect of price caps on rates.

### **Strategy 3: Provide direct government support for users to access information and communication paths.**

*Option A: Provide monetary subsidies to individuals and special groups using information and communication paths.*

Congress might take direct steps to assure access by subsidizing users. This might be done, for example, by providing funding to certain classes of people for the purchase of information or communication services (as in the form of "information stamps") or by subsidizing their rates.

The major argument for government subsidies of this kind is that, without such support, some critical groups in society—such as small-business users, the poor, and public education institutions—will be unable to afford access to communication paths. Subsidies could be targeted specifically to those groups that are most at risk, without distorting the allocation of resources within the marketplace.

If Congress were to pursue such an option, determining which services to subsidize would be a major issue. The FCC, together with a number of States and local telephone companies, has already established "lifeline" programs designed to help low-income and disadvantaged individuals afford telephone service.<sup>102</sup> However, these lifeline services are limited to supporting "plain old telephone service." Less consideration has been given to the

idea that, in an information age, people need to do more than speak on the telephone to actively participate in society.<sup>103</sup>

A second issue, related to the first, is how to fund the subsidies. This will be more problematic in a post-divestiture era, since efforts will need to be made to assure that subsidies do not provide incentives for uneconomic bypass of the public shared communication infrastructure. At the present time, Federal monies for lifeline programs come from the Universal Service Fund, which is funded by a portion of interstate carrier receipts. The FCC uses this fund to match State lifeline contributions on a one-to-one basis. These funds are targeted to low-income residents.

The States have adopted a number of different methods to fund their lifeline subsidies. California, for example, has imposed a tax on interLATA common carriers. In Hawaii, the local telephone companies support lifeline with monies saved from reduced State taxes. The general State budget provides the source of funds for Maryland's lifeline program.<sup>104</sup>

The final issue is who should be subsidized. Traditionally, local telephone rates for all residential users were subsidized by long-distance service. Today, lifeline subsidies are limited to those below a certain income level. This level is usually derived from some percentage of the poverty level or from income levels established for receiving other social benefits, such as food stamps or Medicaid.<sup>105</sup>

*Option B: Provide equipment, or subsidies for its purchase, to individual users.*

Instead of providing monetary subsidies for communication and information services, the government could provide, or subsidize, equipment as a means of fostering access. Such a policy would encourage access in two ways. First, by acquiring equipment, individuals would have more direct

<sup>102</sup>According to *NTIA Telecom 2000*, "Twenty-five states and the District of Columbia have qualified for full assistance under the FCC's 'lifeline' plan, which provides for a waiver of the federal subscriber line charge (currently at \$2.60 per month), as long as states lower local rates by a concurrent amount. Recently, the FCC expanded its lifeline assistance to encourage households without telephone service to join the network by providing a \$30 credit towards the cost of installation." Op. cit., footnote 19, p. 207.

<sup>103</sup>For an argument against including discretionary services together with "plain old telephone service" (POTS) for regulatory purposes, see Gail Garfield Schwartz, "A Scenario for Regulated and Unregulated Telecommunications," *Telematics*, vol. 3, No. 10, 1986, pp. 6-10. According to Schwartz, "If regulators do include discretionary services in POTS and continue to regulate them, the LOC's [local operating companies'] ability to serve the larger business markets at prices low enough to prevent bypass could be impaired. Also, their ability to subsidize riskier operations with earnings from less risky ones, or to subsidize price-elastic services with revenues from services that are competitive but less price-elastic, would be reduced."

<sup>104</sup>Michael V. Russo, "Technology, Deregulation, and the Public Interest in Preserving Universal Telephone Service," *IEEE Technology and Society Magazine*, March 1988, pp. 4-11.

<sup>105</sup>Ibid.

**access to communication** pathways and the information services they provide. Second, to the extent that greater access led individuals to increase their use of services, costs could be spread and prices lowered so **that** more and more people could afford service.

The Government of France has successfully pursued such a policy in its effort to foster the development of a mass market for information services. Since 1982, it has distributed over 3.7 million Minitel terminals throughout France.<sup>106</sup> In the United States, there is much less precedent for, or public acceptance of, government intervention in the private sector communication marketplace on such a scale. Less ambitious efforts to provide or subsidize equipment have been undertaken, although the recipients have typically been institutions rather than individuals.<sup>107</sup> Legislation has been introduced in the past that would have provided taxpayers an income-tax credit for computers in the home purchased for educational, professional, or other essentially nonrecreational use.<sup>108</sup> It was not passed, however, and such legislation is even less likely to find support today in the present political climate of increased budgetary concerns and competition for government funds.

Another obstacle to such a policy is that, to implement it, the government might have to favor one equipment provider over others, an unlikely prospect in a highly competitive economy.

*Option C: Provide public institutions with communication equipment, or increase current funding or subsidies for its purchase.*

The precedent for providing funding or subsidies to institutions (particularly schools, libraries, and research labs) for the purchase of equipment is well established in the United States. For example, funding for educational technology is available to States, districts, and schools through various programs administered by the Department of Education. Funds may be appropriated specifically for educational technology, obligated for technology

projects through existing program areas, or applied from other grants and awards. Federal block grants and other grants to States and school districts support the use of technology at their discretion.<sup>109</sup>

This option would increase the numbers of people who have access to communication pathways and services and might contribute to an increase in overall computer literacy. However, it faces the same obstacles as option B, including budgetary concerns, competition for government funds, and—in the case of providing actual equipment—the problem of designating equipment providers.

#### **Strategy 4: Regulate and/or redefine the rights of media-owners.**

*Option A: Reexamine and reevaluate the traditional regulatory categories of common carrier, print, and broadcasting in the light of technological change and market developments to determine whether they continue to be the most suitable for fostering communication access.*

The evolution of communication regulatory policy in the United States responded to each new technology as it came along. Three bodies of regulatory law emerged—print, common carrier, and broadcasting. Although different in approach, a common element of each was the goal of promoting diversity of and access to information and communication.<sup>110</sup>

Today, historical boundaries that once existed among both technologies and markets are increasingly becoming blurred, raising questions about whether or not these three distinct sets of rules still represent the best means of fostering their intended policy goals. Given these changed circumstances, Congress may want to consider a new regulatory approach that would more accurately reflect technological and market conditions, and thus better meet the goal of providing diversity and access.

One approach would be to base regulatory rules strictly on market structure. This approach assumes

<sup>106</sup>Ellis Booker, "Vive Le Minitel," *Telephony*, Aug. 8, 1988, Pp. 24-32.

<sup>107</sup>H.R. 5573, 97th Cong., 1982.

<sup>108</sup>H.R. 2531, the **Family Opportunity Act**, was introduced by Rep. Newt Gingrich in April 1983. It would have allowed an income tax credit for 50 percent of the expenses paid for computers in the home, limiting the amount for a taxable year to \$100, multiplied by the number of qualified members of the taxpayer's family.

<sup>109</sup>For a discussion of the Department of Education's principal programs providing funds for technology in education, see U.S. Congress, Office of Technology Assessment, *Power On! New Tools for Teaching and Learning*, OTA-SET-379 (Washington, DC: U.S. Government Printing Office, September 1988), app. C.

<sup>110</sup>Pool, *op. cit.*, footnote 38.

that market structure is the principal factor determining access. It is based on the notion that, in a competitive situation, there will always be a number of pathways open to individuals seeking information or an audience, and that, under such circumstances, the cost of access will not be prohibitive. Media pathways that are subject to effective competition would be free to set their own prices and exercise discretion over the information they carry; those that exhibit monopoly characteristics would be required to operate as common carriers.

One benefit of this approach is its relative clarity and consistency. With three distinct and historically based categories of law to draw on and guide them, legislators and regulators have had to spend considerable time and effort trying to categorize new technologies, segregate economic activities, and keep media organizations confined to their appropriate turfs.<sup>111</sup> And stakeholders have often been able to use this confused situation to stifle competition, and thus to actually limit or reduce diversity and access. Finding satisfactory solutions to regulatory problems like these is likely to become even more difficult in the future, given the rapid convergence of communication technologies and markets and the development of new products and services that defy the traditional categories. In contrast, agreement about the definition of monopoly conditions is not likely to change with every new technological development.

However, altering the conceptual basis for regulating content-based communication would be extremely difficult, given the weight of the first amendment and the entrenched interests and property rights of present-day media owners. As demonstrated in *Miami Herald Publishing Co. v. Tornillo*, the Court has denied the government the right to regulate a newspaper on first-amendment grounds,

even when it had monopoly power. And, as recent history has clearly shown, media-owners have been quick to draw on the protection of the first amendment to defend their interests.

Another difficulty is reaching agreement on what constitutes monopoly conditions and when effective competition exists. It is clear that there can be considerable disagreement on these standards, based on the diversity of opinions exhibited in recent stakeholder testimony and comments on the structure of the cable industry<sup>112</sup> and telephone company line-of-business restrictions.<sup>113</sup> Also, definitions of “monopoly” can differ, depending on whether economic or political criteria are used. Whereas an economic analysis will look at power over suppliers who compete in the market, a political analysis will concentrate on “who,” under the circumstances, can gain access to information or use the media.<sup>14</sup>

Given the development of electronic markets, bulletin boards, online data services, videotex, and electronic publishing, the issue of regulatory categories, although deeply troublesome, is likely to persist. If, in the future, everyone is to enjoy access to the benefits of these technologies, Congress may need to act now to reevaluate the most appropriate rules for their use.

*Option B: Rescind the cable/telephone company cross-ownership rules to increase the competition faced by the cable industry.*

As already noted, the cable industry has become considerably more concentrated and integrated since its deregulation under the Cable Act of 1984.<sup>15</sup> Concerned that these market changes will limit access to cable services, a number of policymakers and others have recommended that the telephone companies be allowed to become more involved in

<sup>111</sup> *Ibid.*

<sup>112</sup> See Janusz A. Ordovery and Yale Braunstein, “Does Cable Television Really Face Effective Competition?” In “Competitive Issues in the Cable Television Issue,” hearings of the Subcommittee on Antitrust, Monopolies, and Business Rights of the Senate Judiciary Committee, 100th Cong., 2d. sess., Mar. 17, 1988, pp. 192, 235, and *passim*.

<sup>113</sup> Huber, *Op. Cit.*, footnote 19.

<sup>114</sup> For this distinction, see Pool, *op. cit.*, footnote 38. See also Charles E. Lindblom, *Politics and Markets* (New York, NY: Basic Books, 1977).

<sup>115</sup> For discussions of the market structure in the cable industry, see ch. 3; see also Shooshan, *op. cit.*, footnote 66. According to the author, the major public policy issues surrounding cable television in the 1990s will relate to industry structure and competition.

offering cable services.<sup>116</sup> In its June 1988 report, *Video Program Distribution and Cable Television: Current Policy Issues and Recommendations*, NTIA recommended that telephone companies be freed to provide video dial tone and act as video common carriers, leasing channels to all video programmers. The report urged the removal of current requirements that telephone companies lease channels only to franchised cable operators or franchising authorities. It did not recommend, however, that telephone companies be allowed to provide video services directly to subscribers in their own service areas, their activities being limited in these areas to providing transport, maintenance, and billing services.<sup>117</sup>

The FCC, however, went even further in its proposals, calling for the elimination of the cable/telephone company cross-ownership and video-service restrictions.<sup>118</sup> Support for this position within the FCC has subsequently waned, however. Having dissented from the original the FCC decision, Commissioner Dennis has continually questioned the value of changing the cross-ownership rules. She has suggested, for example, that, if telephone companies are free to own cable systems in their own service areas, they may simply buy out existing plants rather than build competing ones.<sup>119</sup> More recently, Commissioner Quello, reevaluating

his position in the light of public comments, now calls for a full en banc FCC hearing on the issue.<sup>120</sup>

Those who advocate the elimination of the cross-ownership rules argue that, having become monopolies in their own rights, cable companies no longer require the kind of market protection intended by the 1984 cross-ownership ban. In addition, they anticipate that increased competition will have a positive effect on service rates. Moreover, as described in chapter 12, many people argue that by allowing telephone companies to provide video services, they will have a greater incentive to move quickly to deploy fiber optics to the home.<sup>121</sup> Some also note that, to the extent that telephone companies are required to provide video services on a common-carrier basis, access will be extended for all.

The outgoing FCC chairman, Dennis Patrick, was outspoken in his support of this position. Viewing deregulation as inevitable if more competition is not interjected into the industry, he came down squarely in favor of allowing telephone-company entry into the cable area, subject to safeguards.<sup>122</sup> According to Patrick, everyone has something to gain. Not only will there be a greater incentive to develop information services and deploy fiber optics, but program developers and syndicators also will have more

<sup>116</sup>For discussions of this development, see Larry Jaffee, "Cable Comes Under Fire at Senate Antitrust Hearing," *Multichannel News*, Mar. 21, 1988, p. 1; John Wolfe, "Malone Bears Brunt of Hill Hearing," *Cablevision*, May 23, 1988, pp. 12-13; "Cable Has Its Work Cut Out for It," *Broadcasting*, Mar. 28, 1988, p. 31; and Margaret E. Kriz, "Cable's Comeuppance," *National Journal*, Mar. 26, 1988, pp. 807-811. As Shooshan has noted, in the past "problems related to cable's market power have been handled on an ad hoc basis, if at all, by the FCC and other Federal agencies." *Op. cit.*, footnote 66, p. 226.

The telephone companies are prohibited from owning cable systems within their own service areas under the Cable Telecommunications Policy Act of 1984. Moreover, MFJ prohibits the telephone companies from providing information services.

<sup>117</sup>*Video Program Distribution and Cable Television: Current Policy Issues and Recommendations*, NTIA Report 88-233 (Washington DC: U.S. Department of Commerce, June 1988). For discussions, see also "NTIA Opens Pandora's Box for Change in Cable—Beginning With Telco Entry," *Broadcasting*, June 20, 1988, pp. 37-40; and Kathleen Killelte, "Commerce: Ease Curbs, Telcos Eye Options Under NTIA Proposal," *CommunicationsWeek*, June 20, 1988, pp. 1,46.

As NTIA argues, with telephone companies limited to providing common-carrier video dial tone, there would be no danger that they would stifle the development of new programming material. In fact, they would benefit from maximum traffic due to the large number of competitive information product suppliers.

<sup>118</sup>On Sept. 22, 1988, the FCC released a "Further Notice of Inquiry and Notice of Proposed Rulemaking" in CC Docket No. 87-266, which seeks additional comment on a commission proposal to recommend to Congress the abolition of the statutory ban on telephone companies providing cable service within their local telephone service areas. Because the cross-ownership rules are codified in the Cable Communications Policy Act, the FCC cannot repeal them on its own authority. For a discussion, see "FCC Advances Repeal of Networks-Cable Ban," *Broadcasting*, Aug. 8, 1988, pp. 23-24; Fred Dawson, "In Subtle but Sure Ways, Telco Entry Into Cable Goes Beyond 'If' to 'How,'" *Cablevision*, Feb. 15, 1988, pp. 20-22; Melinda Gipson, "FCC Proposes Allowing Telcos to Provide Cable," *Cablevision*, Aug. 1, 1988; and Sam Dixon, "FCC Prepares to Tangle With Cable-Telco Cross-Ownership," *Telematics*, vol. 5, No. 7, July 1988, pp. 12-16.

<sup>119</sup>See Jeannine Aversa, "FCC's Dennis Rejects Telcos' Cable Entry," *Multichannel News*, Nov. 21, 1988, p. 11; and Charles Mason, "Dennis Knocks FCC Cable/Telco Assumptions," *Telephony*, Nov. 21, 1988, p. 15.

<sup>120</sup>See "Quello Having Second Thoughts About Telco Entry," *Broadcasting*, Jan. 16, 1988; see also "Quello Calls for FCC Hearing on Entry of Telcos Into Cable," *Broadcasting*, June 12, 1989, p. 67.

<sup>121</sup>For the presentation of these arguments see, for example, Nicholas P. Miller, "Yes—Telcos Can Provide Better and Less Expensive Service," *Telematics*, vol. 5, No. 12, December 1988, pp. 7, 11.

<sup>122</sup>See "FCC's Patrick Urges Telco Entry Into Cable," *Broadcasting*, June 12, 1989, p. 57.

outlets for their products, while broadcasters will have less need for must-carry legislation.<sup>123</sup>

Some stakeholders, while not opposed to telephone-company entry, are much more cautious and tenuous in their support. Broadcasters have been open to the idea of allowing telephone companies to become more involved in delivering cable services, but only on the grounds that transmission services be provided to them on a common-carrier basis and at no cost. On the other hand, they are divided with respect to whether the elimination of cross-ownership rules should be applied to the television networks as well. While the networks would welcome such a change, affiliates fear that it might lead to anticompetitive behavior on the part of the networks.<sup>124</sup> Moreover, as the Association of Independent Television Stations has told the FCC, there are:

... serious problems of horizontal concentration and vertical integration in the cable industry, and, critically, their injurious effects on cable carriage of local television stations are hardly served by the promise of still greater ownership concentration and vertical integration inherent in network ownership of cable systems.<sup>125</sup>

This perspective, as it pertains to network-cable cross-ownership, has been echoed by MPAA.<sup>126</sup>

Like broadcasters, representatives of the cities, while generally interested in considering such a policy, have their own reservations. Members of the National Association of Telecommunications Officers and Advisers, for example, have expressed the concern that if telephone companies are allowed to operate cable systems in their own service areas, the cities would very likely lose their local regulatory authority over cable service.<sup>127</sup>

Having been highly vocal in their criticisms of integration and concentration within the cable industry, representatives of program suppliers such as MPAA have called for government measures to either deregulate cable, or to bring the telephone companies into the market as competitors. Testifying before the FCC, the representative of a group of producers argued that cable television is a classic bottleneck, and said:

Incumbent cable monopolies control the delivery of broadband video services to the American consumer. There is a crying need for full and fair competition in the delivery of such services. Producers are hopeful that telephone company entry into cable, under *specified* conditions, may hold the answer.<sup>128</sup>

With some exceptions, members of the cable industry are strongly opposed to changes in telco/cable cross-ownership rules. In response to the FCC decision, for example, the National Cable Television Association voted to temporarily increase its membership dues by 15 percent to enable it to wage a more effective campaign against telephone-company entry.<sup>129</sup>

Pointing to the competition from other video program distributors, cable companies deny that they constitute a monopoly.<sup>130</sup> In fact, they argue that the real dangers of monopoly still reside with the telephone companies who, if allowed into the cable business, would use their favored access to poles and conduits to behave in an anticompetitive fashion. To the extent that vertical integration in the cable industry has occurred, cable representatives argue that it has been generally beneficial, leading not to anticompetitive behavior but rather to greater diver-

<sup>123</sup>Ibid.

<sup>124</sup>"Choosing Sides on Network-Cable Crossownership," *Broadcasting*, Oct. 31, 1988, pp. 57-58.

<sup>125</sup>Larry Jaffee, "Big Three, Affiliates Differ on Cable Ownership," *Multichannel News*, Oct. 31, 1988, p.18.

<sup>126</sup>"Choosing Sides on Network-cable Crossownership," op. cit., footnote 124.

<sup>127</sup>For a discussion, see Larry Jaffee, "Telcos' presence Conspicuous at Telecom Convention," *Multichannel News*, Oct. 3, 1988, p. 14.

<sup>128</sup>Joseph W. Waz, Jr., "Cements of Buena Vista Pictures Distribution, Inc., MGM/UA Communications Co., Orion pictures Corp., Paramount Pictures Corp., Twentieth Century Fox Film Corp., and Universal City Studios, Inc. Before the Federal Communications Commission, Washington, DC., CC Docket No. 87-266, Dec. 16, 1988.

<sup>129</sup>See "NCTA Blasts Bureau's Telco-Cable Decision," *CommunicationsWeek*, May 22, 1988, p. 40; and "NCTA Votes 15% Dues Surcharge to Fund Telco Fight," *Broadcasting*, Oct. 3, 1988, p. 29.

<sup>130</sup>See, for this argument, John M. Draper, "The Telco Cross-Ownership Restrictions: A Cable Perspective," paper presented at the Media Institute luncheon series, Washington, DC, Apr. 19, 1989. See also, Charles Mason, "Who Are the Real Monopolists? Telcos, NCTA Trade Charges," *Telephony*, Dec. 26, 1988, pp. 10-11. As noted by Shooshan, the problem in determining the extent of competition on the basis of the existence of other video program distributors is "that there is no fixed standard to define how close the competitive substitutes must be in order to provide workable competition. Thus, conclusions tend to be extremely subjective." Op. cit., footnote 66, p. 230.

sity in programming.<sup>131</sup> Countering the argument that telephone-company entry will lead to reduced rates, cable companies contend that, on the contrary, with the elimination of the cross-ownership rules, telephone ratepayers will be overcharged to help defray the costs of telephone company entry into the television business. They also take issue with the argument that the cross-ownership rules discourage modernization, arguing that fiber will be introduced within a reasonable timeframe without the revenue support from cable television. \*32 There are, however, some multiple service operators who support telephone-company entry, viewing the telephone companies as potential bidders who, having plenty of money to spend, are likely to raise the price of purchasing their systems.

**Option C: Provide common-carrier status for critical navigational tools, recognizing their essential-facility nature.**

As already noted, navigational tools are becoming increasingly important for effective communication. Information users need such tools to help them locate information in a form and format that is most useful to them. Information providers need navigational tools not only to help them identify the most efficient modes of transmission, but also to assist them in identifying and making themselves known to potential audiences. Moreover, because the value of such tools is likely to increase in the future—together with the amount of available information, its growing strategic importance, and the development of new transmission modes—new rules governing access to them may be required. In particular, Congress may want to provide common-carrier status for critical navigational tools, recognizing their essential-facility nature. Such a policy assumes not only that such tools are becoming increasingly critical, but also that the structure of the market is such that effective competition is lacking and access is limited.

Providers of navigational tools are unlikely to favor the status of common carrier. Like other

providers of information media, they would most likely view such restrictions as infringing on their first-amendment rights and depriving them of significant market opportunities. To date, this status has been granted only when it has been established that facilities are essential. Individuals who might otherwise be excluded from gaining access to information will argue that they are being deprived of an essential service. Thus, the issue might hinge on what constitutes first-amendment rights, as well as an essential service, in the economic realm, given the enhanced role of information in society.

**Option D: Strengthen requirements to provide public access to production facilities.**

The Cable Communications Policy Act of 1984 included provisions that grant franchise bodies the authority:

... to enforce any provisions of the franchise for services, facilities, or equipment proposed by the cable operator which relate to public, educational, or governmental use of channel capacity.<sup>133</sup>

Public-access channels have had mixed success, as program producers often suffer from lack of funding, inadequate equipment, and viewer apathy. While some have been pleased with the quality of programming,<sup>134</sup> others have viewed it as marginal.<sup>135</sup> Conditions are changing, however, and such a policy might now be more successful. Not only is there more user-friendly equipment available for producing content, but the cable audience is now large and perhaps diverse enough to encourage more varied programming.

Reinforcing such a policy would be strongly opposed by the cable industry if it were expected to bear the costs of additional facilities. It also raises the question of whether such a policy might also be extended to other forms of media. This issue might become much more complex if telephone companies were allowed into the information-services business. Congress would need to decide whether telephone companies, too, would have special obligations to

<sup>131</sup>Draper, *op. cit.*, footnote 129. See also Benjamin Klein, "The Competitive Consequences of Vertical Integration in the Cable Industry," June 1989, University of California, Los Angeles.

<sup>132</sup>For one account of these arguments, see "Should the FCC Modify Its Policies Concerning Cable/Telco Cross-Ownership?" Frank W. Lloyd, "No: We Should Fear a Single Information Pipeline to the Home," *Telematics*, vol. 5, No. 12, December 1988, pp. 8-10.

<sup>133</sup>611(c), codified at 47 U.S.C. 531(c).

<sup>134</sup>See discussion of cable community access channels in ch. 7.

<sup>135</sup>Thomas Streeter, "Cable Fable Revisited: Discourse, policy, and the Making of Cable Television," *Critical Studies in Mass Communication*, vol. 4, 1987, p. 195.



provide the public with access to production facilities and assist them in producing content.

**Strategy 5: Influence the level and availability of the tools and resources required to access communication and information services.**

*Option A: Foster the relationship between the producers and distributors of communication content.*

Congress could act as a facilitator by brokering the relationship between the independent and minority producers and distributors of information. Such a function might be assigned to, for example, the National Endowment for the Arts or the National Endowment for the Humanities. The major constraint of this option is the cost. In addition, traditional producers may oppose assistance to independent producers if they see them as potential competitors. On the other hand, they might view this option as beneficial if it serves to enrich the overall creative environment.

*Option B: Provide Federal support for technological literacy programs.*

The Federal Government might provide support for the development of programs to train individuals in the use and ethics of using new communication technologies and in evaluating content. One way of doing this would be to tap into the expertise that the Department of Defense has developed in technology training.<sup>136</sup> Since a comprehensive policy might be extremely costly-involving equipment support, teacher training, and the establishment of new centers for learning-one argument against this policy would be cost constraints. However, these could be ameliorated by supporting training efforts that are already under way. Assuming a role in coordination might be the most effective way to leverage Federal dollars. Another argument against this option would be that it is impossible to deal with technological literacy without addressing the underlying problem of the lack of basic literacy.

It is unlikely that the educational community would oppose this option; however, some would

argue that government support for literacy should be funneled through State and local authorities in order to minimize bureaucracy and to best target local needs.

*Option C: Increase funding and support for direct research on navigational tools.*

Present government support is limited primarily to designing navigational tools to assist scientific, military, and technical research. Given the enhanced role of communication in the political, cultural, and economic realms, government may want to develop a more aggressive policy to assure the transfer of this expertise to other sectors.

Support for or opposition to such a policy would depend on how it was implemented. Opposition will develop if some groups are favored at the expense of others; for example, government support for one kind of equipment standard will put other vendors at a disadvantage. On the other hand, users will benefit. To the extent that this option served to equalize opportunities for gaining access to communication paths, it might be opposed by those who currently can use navigational tools to gain strategic advantage.

*Option D: Provide funding for creation of bibliographical devices for publicly funded programs and information.*

The Federal Government already provides a variety of bibliographic services, such as the Department of Education's ERIC (Educational Resources Information Center) and AGRICOLA, compiled by the National Agricultural Library. Those who wish to provide alternative services in the marketplace would be opposed to this option. The information industry argues that these services can be better provided in the marketplace. These issues are discussed in considerable depth in the OTA study, "Informing the Nation,"<sup>137</sup> and will not be discussed here.

<sup>136</sup>An example of such an arrangement is provided in the Training Technology Transfer Act of 1988 (20 U.S.C 509). To take advantage of the investment of public funds already made in the development of education and training software, particularly in the Department of Defense, this act facilitates the transfer of education and training software from Federal agencies to the public and private sectors and to State and local governments and agencies, including educational systems and educational institutions, in order to support the education, training, and retraining of industrial workers, especially workers in small business concerns.

<sup>137</sup>OTA, *op. cit.*, footnote 52.

### Strategy 6: Assume a more proactive role to assure robust debate on issues of public importance.

A major purpose of the first amendment is to protect the free discussion of governmental affairs.<sup>138</sup> At this time, the government's role in assuring a diverse "marketplace of ideas" is ambiguous. In the print media, the government plays almost no role in promoting debate on public issues. In broadcasting, although the FCC has ruled that the Fairness Doctrine is an unconstitutional infringement on the first-amendment rights of broadcasters,<sup>139</sup> the Equal Time Requirement and the Public Trustee Standard still appear to be in force. A more proactive government role might include congressional options such as the following.

*Option A: Codify the Fairness Doctrine for broadcasters and/or extend it to other media.*

Most broadcasters and other media providers, as well as the present FCC, are opposed to this option. They claim that there is now an abundance of media channels, and thus the Fairness Doctrine is no longer justified on the grounds of spectrum scarcity. They also maintain that the Fairness Doctrine does not promote the diversity of messages, but in fact has a chilling effect because broadcasters are reluctant to broadcast controversial materials and risk being accused of providing unbalanced coverage. This argument, however, ignores the fact that the Fairness Doctrine itself requires coverage of controversial issues.

A number of public interest groups—such as the Media Access Project, the American Civil Liberties Union (ACLU), and the United Church of Christ—favor the Fairness Doctrine because they believe it gives them leverage in getting public issues aired. Two broadcasters, Fisher Broadcasting Inc. and Westinghouse Broadcasting and Cable Co., assert that the Fairness Doctrine does not inhibit their coverage of controversial issues of public importance.<sup>140</sup> If the Fairness Doctrine were reinstated, however, the public-trustee status of broadcasters might be less open to challenge, enabling them to argue against spectrum licensing or any proposal to give them common-carrier status.

One criticism of the Fairness Doctrine has been that it singles out the broadcasting media and requires them to give a certain type of coverage to issues of public importance. Such a standard has not been imposed on the print media.<sup>141</sup> Although cable is legally required to comply with the Fairness Doctrine, the FCC has not enforced the doctrine since 1974.<sup>142</sup> Given the difficulties certain groups have in accessing communication paths and the lack of diversity in messages carried (see chs. 6 and 7), Congress could extend the Fairness Doctrine to all media. However, many would oppose this approach, fearing that such government regulation would lead to government control over content. The Supreme Court's Miami Herald ruling,<sup>143</sup> which invalidated Florida's right-of-reply statute as a violation of the first amendment's freedom of the press, would be a precedent for invalidating an extension of the Fairness Doctrine to the print media.<sup>144</sup>

<sup>138</sup>The Supreme Court has recognized the special status for first-amendment protection of communication related to political affairs in a number of instances. In *Roth v. United States*, 354 U.S. 476, 484 (1957), the Court stated that the first amendment affords the broadest protection to political expression in order "to assure [the] unfettered interchange of ideas for the bringing about of political and social changes desired by the people." Similarly in *The New York Times v. Sullivan*, 376 U.S. 254, 270 (1964), the Court spoke of the "profound national commitment to the principle that debate on public issues should be uninhibited, robust, and wide open."

<sup>139</sup>On Aug. 4, 1988, the FCC declared the quarter-century-old Fairness Doctrine unconstitutional. Rep. John Dingell (D-Mich) and Senator Ernest Hollings (D-S. C.) have led efforts to reinstate the Fairness Doctrine and give it statutory status; however, they did not have enough votes to override a threatened veto by President Reagan. Prior to the FCC's action, Congress had passed a bill to codify the Fairness Doctrine (S.742 was passed by the Senate on Apr. 21, 1987, and H.R. 1934 was passed by the House on June 3, 1987), which was vetoed by President Reagan on June 19, 1987.

<sup>140</sup>The FCC's Meredith decision as quoted in Broadcasting, Aug. 10, 1987, p. 39-F.

<sup>141</sup>The argument for this discrepancy has been based on broadcasting's scarcity of spectrum. See *Red Lion Broadcasting v. FCC*, 395 U.S. 367, 1969.

<sup>142</sup>FCC imposed the Fairness Doctrine on cable systems in 1969 (sec. 76-209 C.F.R.). See George H. Shapiro, Philip B. Kurland, and James P. Mercurio, *Cable Speech* (New York, NY: Law & Business, Inc., 1983), pp. 49-75; and Daniel L. Brenner and Monroe E. Price, *Cable Television and Other Nonbroadcast Video* (New York, NY: Clark Boardman Co., Ltd., 1986), pp. 6-72-6-74.

<sup>143</sup>In *Miami Herald Publishing Co. v. Tornillo*, 418 U.S. 241 (1974), the Supreme Court held unconstitutional a Florida law that gave political candidates a right of reply to newspaper criticism on the grounds that the first amendment freedom of the press prohibits any governmental regulation of the press that would require it to print something it would not otherwise print. One of the Court's concerns was that editors might not print political editorials in order to avoid controversy.

<sup>144</sup>Thomas M. Durbin, "Extending the Fairness Doctrine to the Print Media," Library of Congress, Congressional Research Service, CRS Report 87-584 A, June 17, 1987.

*Option B: Mandate time and space on communication pathways for discussion of public policy issues.*

Rather than regulating the content of media, as the Fairness Doctrine does, Congress could instead regulate the structure of media access in order to provide more diversity.<sup>145</sup> For example, Congress could subsidize those wishing to use existing media for public affairs discussions, designate certain cable channels for such discussions, prohibit multiple ownership or require diversity of ownership, or establish new public forums, such as computer bulletin boards and publicly supported broadcasting stations. Henry Geller has proposed that broadcast station-owners be charged a "spectrum fee" that would be used to subsidize public-affairs programming on public radio and television. The National Association of Broadcasters (NAB) has suggested that revenue to improve access to media for public affairs programming--specifically access to public broadcasting--should come not from the broadcasters, but from consumers in the form of taxes on TVs, radios, and VCRs.<sup>146</sup>

Owners of private media would probably oppose this option to the extent that they would lose advertising revenues. One argument against this option is that most people do not watch public affairs programming and that increasing the amount of coverage or improving the quality of coverage will not change public behavior.

*Option C: Require media providers to uphold more stringent public-interest standards.*

At present, there are no explicit public-interest standards. One option, therefore, would be for Congress to establish explicit standards and measures for what constitutes public-interest programming. For example, Congress could establish quantitative measures for particular programming categories, such as children's programming and local public affairs.<sup>147</sup> However, there have been problems with such policies in the past, particularly in

formulating, overseeing, and actually enforcing guidelines. Broadcasters and civil libertarians have been strongly opposed to any government intervention in program content. For example, the 100th Congress passed a bill (H.R. 3966) to reimpose limits on the amount of advertising on children's television shows. The bill was opposed by the FCC and the Department of Justice, but NAB said that broadcasters could live with this measure. The bill was supported by Action for Children's Television and many public interest groups concerned about family values.<sup>148</sup> President Reagan pocket-vetoed the bill, saying that "this bill simply cannot be reconciled with the freedom of expression secured by our Constitution."<sup>149</sup>

Alternatively, Congress could relax antitrust regulations to allow the media to cooperate in developing voluntary standards for certain program areas. Such legislation has been proposed with respect to violence in programming.<sup>150</sup> The ACLU opposed the bill on the grounds that it represented congressional control over portions of TV content. Although the networks opposed the bill, NAB did not; however, they expressed concerns about how the guidelines would be implemented. Children's advocates, including many in the medical profession, support controls on violence on TV.<sup>151</sup>

*Option D: Adopt campaign-reform legislation.*

As chapter 6 points out, the costs of political campaigns restrict access to communication paths for both potential candidates and citizens who want to influence the electoral process through campaign contributions. Accompanying the increase in campaign expenditures has been a decrease in voter turnout, an increase in political cynicism, a decrease in the importance of political parties, and an increase in the influence of political action committees (PACs) and political consultants. Part of the increasing cost of campaigns can be attributed to the high costs of waging a media campaign.

<sup>145</sup>"Freedom and Fairness: Regulating the Mass Media," *Philosophy and Public Policy*, vol. 6, No. 4, Fall 1986, pp. 1-5.

<sup>146</sup>John Burgess, "Broadcasters Offer Plan to Tax Sales of TVs, Radios and VCRs," *The Washington Post*, Nov. 10, 1987, P. F3.

<sup>147</sup>For a discussion of past efforts to establish quantitative standards for broadcasters, see Douglas Ginsburg, *Regulation of Broadcasting* (St. Paul, MN: West Publishing Co., 1979), pp. 142-149.

<sup>148</sup>Paul Starobin, "Bill to Boost Quality of Kids' TV Clears Despite Veto Possibility," *CQ Weekly Reports*, Oct. 22, 1988, P. 3065.

<sup>149</sup>"Reagan Pocket-Vetoes Bill on Children's TV," *The Washington Post*, Nov. 6, 1988, p. A6.

<sup>150</sup>S. 844 was passed by the Senate, but H.R. 3848 did not pass the House. "ACLU Attacks TV Violence Bill," *TV Digest*, Oct. 10, 1988, p. 6.

<sup>151</sup>Jody W. Zylke, "More Voices Join Medicine in Expressing Concern Over Amount, Content of What Children See on TV," *JAMA*, Oct. 7, 1988, vol. 260, No. 13, pp. 1831, 1835.

To reform political campaigns, Congress could consider the following options:

- extend public funding, such as that provided to presidential candidates, to congressional candidates, State or local candidates, and nonprofit groups; 152
- reconsider and extend the limits on individual campaign contributions;<sup>153</sup>
- decrease the amounts that PACs can contribute to a candidate or establish an overall limit on the PAC contributions that Federal candidates can accept;<sup>154</sup>
- restrict the length of the campaign season; 155
- clarify what is meant by “lowest unit rate” that can be charged for political broadcasting;<sup>156</sup>
- provide free media time to candidates for Federal offices; 157

- initiate legislation placing limits on the amount of money that can be spent on political advertisements;<sup>158</sup>
- impose standards on the form of political advertisements, thereby making them more uniform, cheaper, and less subject to price differences;<sup>159</sup>
- hold hearings to assess the impact of negative advertising on recent Federal elections and consider ways to regulate negative advertising;
- investigate the impact of media practices, such as news-program coverage of political candidates<sup>160</sup> and polling;<sup>161</sup> and
- investigate the influence of political consultants and the impact of technology-supported campaign practices.

<sup>152</sup>In the 100th Congress, the focal point of such efforts was the Senatorial Election Campaign Act of 1987 (S.2), introduced by Senators **Boren** and **Byrd**, which provided public financing and spending limits in Senate elections. Republicans opposed to spending limits and public funding were able to filibuster the bill. For a review of campaign financing reform, see Joseph E. Cantor and Thomas M. **Durbin**, “Campaign Financing,” Library of Congress, Congressional Research Service, **CRS Issue Brief**, May 12, 1988.

<sup>153</sup>One loophole that Congress created in 1979 is that national parties can solicit unlimited contributions from corporations, labor unions, and individuals for State and local parties, routine expenses, and party-building activities. See Charles R. Babcock, “\$100 Million in Campaign Donations Belie Notion of Federal Limits,” *The Washington Post*, Nov. 8, 1988, p. A12, and Carol **Matlack**, “Backdoor Spending,” *National Journal*, Oct. 8, 1988, pp. 2516-2519.

<sup>154</sup>A number of such bills have been proposed, including the Campaign Reform Act of 1987 (H.R. 166), the Comprehensive Campaign Finance Reform Act of 1987 (H.R. 573), the Senate Campaign Cost Limitation and Public Financing Act (S.645, S.725), and the Bipartisan Commission and Congressional Campaign Financing Act (S.1672). See Cantor and **Durbin**, op. cit., footnote 151, p. 6. Such changes, however, could be sidestepped by PACs increasing their independent expenditures, which under *Buckley* cannot be limited.

<sup>155</sup>A restricted Campaign season could be a requirement for receiving public funding, as is presently the case. Affecting the length of campaigns might also be accomplished by reforming the nominating process. Either a national primary or a regional primary might restrict the length of pre-convention campaigning. Kevin J. Coleman, “The Presidential Nominating Process: The Regional Primary Movement and Proposed Reforms,” Library of Congress, Congressional Research Service, **CRS Issue Brief IB861** 17, Mar. 7, 1988.

<sup>156</sup>The Campaign Cost Reduction Act (S. 2627) would establish that a station’s charge for preemptible political time would have to equal its lowest preemptible rate for that spot, and that a fixed spot rate could be no more than one-half again the preemptible rate. “Congress Looks for Better Deals on Campaigns,” *Television/Radio Age*, Oct. 3, 1988, p. 17.

<sup>157</sup>For example, in the 100th Congress, Representative **Stratton** introduced the Free Political Broadcasting Act of 1987 (H.R. 521) to provide free radio and TV time to Federal candidates. He also co-sponsored, with Senator **Pen**, the Informed Electorate Act of 1987 to require TV stations to provide free time to political parties for communications by House and Senate candidates.

<sup>158</sup>The 1971 Federal Election Campaign Act imposed spending limits on media advertising by Federal candidates, but these were repealed in 1974. To be consistent with *Buckley*, limits on advertisements would have to be part of a public funding scheme.

<sup>159</sup>In the 98th Congress, Senators **Rudman** and **Inouye**, adopting this approach, introduced the Fairness in Political Advertising Act. Among other things, this act would require that the purchaser of the ad or a designee: 1) speak to the camera for the duration of the ad; 2) permit some variation in backgrounds, provided they are taken with the same lens as the speaker; and 3) mandate written material identifying the speaker and purchaser of the ad. **Curds B. Gans**, testimony before the Senate Committee on Commerce, Science, and Transportation, Sept. 10, 1985, pp. 12-13.

<sup>160</sup>The FCC has exempted broadcasters from the equal time requirements when candidates appear on a bona fide news interview or documentary program, which includes television shows such as “Donahue” and “Entertainment Tonight.” Some candidates supply tapes to broadcast stations, raising another question about the definition of a bona fide news program. **Jack Loftus**, “FCC Goes Easy on Political TV,” *Television/Radio Age*, Apr. 4, 1988, pp. 43, 132.

<sup>161</sup>A number of bills have been introduced to either restrict the use of or lessen the impact of exit polls. One proposal that has been supported by the media is to adopt a uniform poll-closing time; the networks have given their verbal commitment that, if such a law were enacted, they would not announce exit-poll results until the polls closed. Statements of representatives from ABC, CBS, and NBC on S. 182 before the Senate Committee on Rules, May 12, 1988.

## Chapter 10

# Security and Survivability of the Communication Infrastructure

## C O N T E N T S

INTRODUCTION .. . . . . + + . +. . . . .	275
THE PROBLEM .. . . . .	275
STRATE GIES AND OPTIONS .. . . . . ,6+ .. . . . . ++, .. . . . .	282

### *Figures*

#### *Figure*

10-1. Vulnerability of Industries to Computer Outages .. . . . .	<del>276</del>
10-2. Severity of Loss Due to Computer Outages .. . . . .	277
10-3. 1988 Increase in Computer Devices Infected by Viruses, .. . . . .	278
10-4. Four Stages of Viral Infection of Computer Systems .. . . . .	
10-5, Congressional Strategies and Options To Address Security/Survivability., .. . . . .	279
of the Communication Infrastructure .. . . . .	283

# Security and Survivability of the Communication Infrastructure

---

## INTRODUCTION

Security and survivability are essential characteristics of the communication infrastructure.<sup>1</sup> However, establishing a secure and survivable infrastructure requires tradeoffs between security and survivability on the one hand, and access, cost, and ease of use on the other.<sup>2</sup> Experts estimate, for example, that security features constitute approximately 10 to 20 percent of a network's overhead costs. Moreover, adding features to provide additional security not only increases network traffic; it also slows down the speed of transmission. Thus, although most people would probably support the general goals of security and survivability, they might disagree significantly on the levels of security and survivability required, and the extent to which other communication goals should be sacrificed in order to achieve them.

## THE PROBLEM

In the past, the security and survivability problems of the communication infrastructure were not particularly germane to most members of the American public. Where such issues did arise, they were generally resolved outside the public policy arena, either in the private sector or behind the scenes in government. In the future, these issues will become less containable. OTA found that security and survivability are becoming more important and more visible as communication policy goals; in addition, it is becoming more difficult to make the tradeoffs required to achieve them. Equally important, OTA found that the views of stakeholders may diverge to a greater extent over how these tradeoffs should be made. Moreover, the institutional mechanisms by which security and survivability issues are to be resolved and security goals achieved are not opti-

mally designed. OTA identified a number of factors that might contribute to security and survivability problems in the communication infrastructure. They include:

1. the increased reliance of business and government on communication and information-based systems, and hence a greater vulnerability to their failure;
2. an increase in the number and variety of problems that may threaten the security or reliability of communication systems;
3. an increase in the complexity, decentralization, and interdependence of communication systems and, hence, in the difficulty of coordinating them to achieve security and survivability goals;
4. a growing divergence in stakeholder needs for security and reliability; and
5. an increase in the number of people who have access to communication systems and who are knowledgeable about their use, occurring at a time when there is no consensus about the legitimate use of the technology.

These factors are discussed below.

### ***Factor 1: The increased reliance of business and government on communication and information-based systems, and hence a greater vulnerability to their failure.***

Chapters 5 and 6 depict the growth and dependence of business and government on communication and information-based systems. More and more, in all business activities, companies are employing their communication systems and the information stored in them to achieve a competitive advantage. In addition to using these systems to extend their markets, many businesses are using them to actually

---

<sup>1</sup>The word "survivability" is used here to denote reliability, recoverability, contingency planning, and/or Operating under extreme conditions.

<sup>2</sup>One instance where this tradeoff is evident is the UNIX operating system. UNIX's open structure made it highly popular among academics and researchers, who spent years enhancing its flexibility. But, by virtue of its openness and its capacity for networking, UNIX has suffered from being inherently more vulnerable and insecure. For a discussion, see Sanford Sherizen and Fred Engle, "Striving for UNIX Security," *Computerworld*, Mar. 20, 1989, pp. 85-93. For a discussion of the tradeoff between security and access, and the special problems that this tradeoff presents to the research community, see Kelly Jackson, "Virus Alters Networking," *CommunicationsWeek*, Nov. 14, 1988, pp. 1, 75.

restructure their organizations on a regional or global basis. Thus, the failure of a communication system can lead not only to market losses, but also to the failure of the business itself. For an indication of industry vulnerability to computer outages, see figure 10-1.

In a recent survey conducted by the Center for Research on Information Systems, University of Texas at Arlington, researchers identified four major consequences for businesses when information/communication systems fail:<sup>3</sup>

1. the reduction in, or perhaps complete termination of, the business function;
2. a loss in revenues;
3. increased costs of doing business; and
4. intangible costs entailed in the loss of image and customers, or legal or regulatory violations.

As depicted in figure 10-2, the damage to business increases with the time it takes to achieve recovery.

Government, too, is becoming more dependent on communication and information systems, and hence more vulnerable to their failure.<sup>4</sup> Faced with increased costs and budgetary constraints, many government agencies are looking to communication systems as a way of improving the efficiency and effectiveness of their operations. For example, online telecommunication systems are now being used for the delivery of Medicare and food stamp benefits, as well as for processing Federal income tax forms.<sup>5</sup> Failures in these systems will not only create administrative havoc and serious problems for the individuals involved, but they may also serve to

**Figure 10-1-Vulnerability of Industries to Computer Outages**

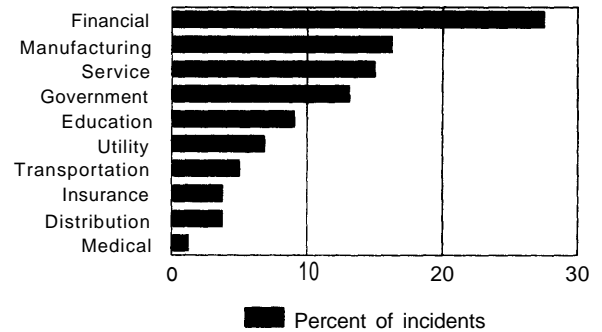

<sup>3</sup>Based on 1,000 disasters tracked over a 2-year period

SOURCE: Copyright 1989 by CW Publishing Inc., Framingham, MA 01701. Reprinted with permission from *Computerworld*, Vol 23, No. 16, Apr. 17, 1989, p. 21.

undermine the support for, and legitimacy of, government operations themselves.

The need for a secure and survivable communication infrastructure has become especially acute in the realm of national security and emergency preparedness. It has long been a matter of national policy that telecommunication services required by the Federal Government, including for defense purposes, should be procured from the commercial sector, unless special circumstances dictate otherwise.<sup>6</sup> However, the operational requirements to meet the government's security and defense needs are becoming greater and greater all the time. For example, in October 1981, President Reagan announced a strategic modernization plan that was designed to prevent the realization of strategic

<sup>3</sup>Steven R. Christensen and Lawrence L. Schkade, "Financial and Functional Impacts of Computer Outages on Businesses," CRIS-87-01, Center for Research on Information Systems, College of Business Administration, The University of Texas at Arlington, TX, January 1987.

<sup>4</sup>See U.S. Congress, Office of Technology Assessment, *Defending Secrets, Sharing Data: New Locks and Keys for Electronic Information*, OTA-CIT-310 (Washington, DC: U.S. Government Printing Office, October 1987); and U.S. Congress, Office of Technology Assessment, *Federal Government Information Technology: Management, Security, and Congressional Oversight*, OTA-CIT-297 (Springfield, VA: National Technical Information Service, February 1986).

<sup>5</sup>See Katherine McGrail, "The Government's Expenditures on Data Will Soon Equal Money Spent on Voice," *Government Networking*, Sept. 21, 1987, pp. 7-14.

<sup>6</sup>Such a policy, however, has not been without its opponents. The "Continuing Resolution for Appropriations for Fiscal Year 1988" requires all government agencies to be connected to the Federal Telecommunications System 2000 (FTS 2000), although some exemptions will be made on the basis of existing systems and special needs. The Defense Nuclear Agency and the U.S. Army, Navy, and Air Force, among others, have generally resisted transferring their services to FTS 2000 for both logistical and security reasons. In December 1988, contracts (estimated to be worth \$3 billion to \$15 billion, depending on the number of Federal agencies included) were awarded to American Telephone & Telegraph Co. (AT&T) and U.S. Sprint Communications Co. to build the all-digital private network for the government. In accordance with the contract, AT&T will be responsible for developing a network for agencies representing 60 percent of all traffic, while U.S. Sprint will handle the rest. See Mitch Betts, "Feds Sign FTS 2000 Net Pact," *Computerworld*, Dec. 12, 1988, pp. 1, 4. See also Kelly Jackson, "Gov't May Be Forced To Deal Only With FTS-2000 Winner," *CommunicationsWeek*, Aug. 1, 1988, p. 16.



**Figure 10-2--Severity of Loss Due to Computer Outages**

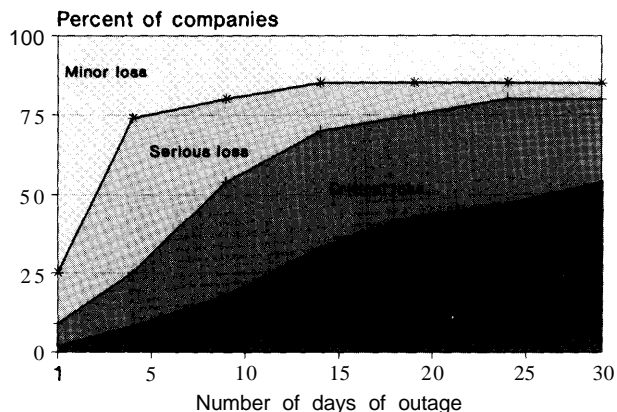

SOURCE: Center for Research on Information Systems, The University of Texas at Arlington. Reprinted with permission from *Computerworld*, vol. 23, No. 11, Mar. 13, 1989, p. 1. Copyright 1989 by CW Publishing Inc., Framingham, MA 01701.

dominance by the Soviet Union. In essence, U.S. deterrence strategy, encapsulated in National Security Decision Directive-13 (NSDD-13), was moved one stage further from one based on mutual assured destruction, or even flexible response and counterforce nuclear targeting, to one of flexible response in which the United States would be equipped, and demonstrably able, to prevail in any conflict from low-intensity operations to prolonged strategic nuclear war. For the policy to succeed, and to be credible, U.S. military Command, Control and Communications and Intelligence (C<sup>3</sup>I) systems had to be "fool-proof."<sup>7</sup>

Extensive reliance on technology may also make it more difficult for organizations to recover from system failures.<sup>8</sup> When technical problems occur, the people trained to operate systems manually may no longer be available. The Department of the Navy was confronted with such a situation, for example, in the late 1970s. When faced with a computer outage in their computer-based Combat Information Centers, the Navy's radar operators found it very difficult to effectively perform their task of target-

tracking because many of their basic skills had become rusty.<sup>9</sup>

**Factor 2: An increase in the number and variety of problems that may threaten the security or reliability of communication systems.**

With the advance of information and communication technologies, communication systems are becoming vulnerable to a much wider range of possible disasters—from earthquakes, fires, and floods, to power outages, disk crashes, and intruding hackers.<sup>10</sup> Two major incidents occurred in 1988 that illustrate the variety of system security/reliability problems that can occur, as well as the extent of the damage that can result. These events were a fire at Illinois Bell Telephone Co.'s Hinsdale central office; and the most serious case of computer hacking to date, involving the implanting of a computer virus into the Internet, a major packet-switching network that connects research and government computers.

The Hinsdale fire occurred on May 8, 1988, at a major transmission hub that links local telephone switching centers with one another and with long-distance networks. The center provides voice and data communication services to several communities, as well as to a number of corporate data networks operated by companies such as United Air Lines, Montgomery Ward & Co., American Express Co., and Sears. Approximately 42,000 local lines and 118,000 trunks for local and long-distance call-routing are connected to the Hinsdale central office. In the wake of the fire, services were suspended for 7 days. An investigation found that, similar to many such incidents, the disaster resulted from both human error and mechanical failure—in this case, faulty wiring. Many who were affected by the outage sought unspecified damages for their losses. However, the court ruled to dismiss their class-action suit, on the grounds that an existing Illinois tariff limits telephone company liability in the event of a service outage to a 200-percent credit, which in this case amounted to approximately \$3.5 million. However, to reassure its customers about

<sup>7</sup>Martin Edmonds, "Defense Interests and United States Policy for Telecommunications," OTA contractor report, June 1988, p. 30.

<sup>8</sup>Steven R. Christensen and Lawrence L. Schkade, "Surveying the Aftermath," *Computerworld*, Mar. 13, 1989, p. 82.

<sup>9</sup>Ibid.

<sup>10</sup>Peter Scisco, "No Such Thing as a Small Disaster," *Computerworld*, July 11, 1988, pp. S I-S11.

the integrity of the network, Ameritech announced that it will invest \$80 million during the next 5 years to preclude a similar mishap in the future.<sup>11</sup>

The impact of the fire in Hinsdale was not only felt by those in the immediate vicinity. Throughout the country, many users began to examine and investigate the security and reliability of their communication networks. For example, a number of large users and user organizations in New York began to press the public telephone company to develop an emergency backup system that would allow them to connect their businesses to two central offices instead of one. \*2 The fire not only heightened users' awareness of their growing vulnerability; it also raised some fundamental questions about liability in the event of major system failures.<sup>13</sup>

Reinforcing and underscoring this growing concern about system vulnerability has been the significant growth in the phenomenon of computer viruses.<sup>14</sup> As can be seen in figure 10-3, while only 3,000 machines were damaged by viruses in the first 2 months of 1988, over 30,000 systems were affected in the last 2 months of the same year.<sup>15</sup> Moreover, because viruses occur surreptitiously and act subtly to cause all sorts of damage, they serve to epitomize and symbolize the unpredictability of communication system failure, and the problems of anticipating and preparing for it. In fact, as depicted in figure 10-4, the damage resulting from computer viruses occurs in a series of four stages, becoming increasingly more severe the longer the virus remains unobserved.

One of the most publicized and disruptive computer-virus incidents to date occurred in November 1988, when it was reported that a 23-year-old, first-year computer science graduate student at Cornell University had tapped into the Internet

**Figure 10-3--1988 Increase in Computer Devices Infected by Viruses** <sup>14</sup>

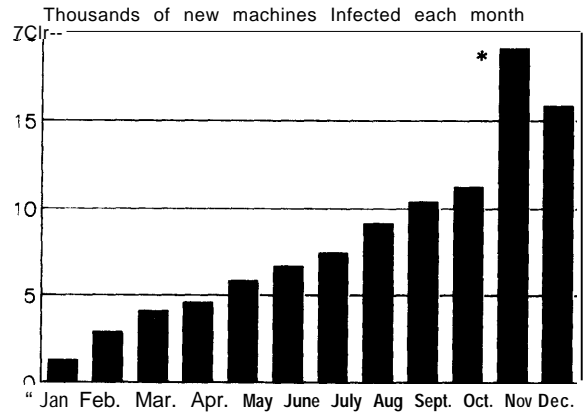

<sup>14</sup>Includes the Internet infection

SOURCE Copyright 1989 by CW Publishing Inc., Framingham, MA 01701. Reprinted with permission from *Computerworld*, vol. 23, No. 6, Feb. 13, 1989, p. 90.

network. By taking advantage of a well-known weakness in the UNIX operating system and its accompanying electronic mail application, Sendmail, a virus was implanted that, within a few hours, infected more than 6,200 computers. Among the networks affected were those belonging to a number of government laboratories, including the Lawrence Livermore National Laboratory in California where research is conducted on nuclear weapons and civilian energy.<sup>16</sup>

Given the growing number of ways in which communication systems are becoming vulnerable, users now have to adopt multiple approaches to provide for secure and survivable networks. This requirement complicates the processes entailed in protecting communication networks, and can greatly add to the expense of providing that protection.

<sup>11</sup>Steven Titch, "Illinois Delays Fire Report," *CommunicationsWeek*, No. v. 14, 1988, p. 12; and Beth Schultz, "Ill. Bell Crafts Disaster Plan," *CommunicationsWeek*, Mar. 20, 1989.

<sup>12</sup>John Foley, "Telco Switch Vulnerability Worries Financial Users," *CommunicationsWeek*, June 27, 1988, pp. 1, 17.

<sup>13</sup>*Ibid.* As Foley notes, although most users already have their own contingency plans—including those that use fiber optics, microwave, or satellite systems—to bypass the local loop, most of their plans to restore their private networks in the event of disaster require a healthy public network.

<sup>14</sup>A virus is a computer program that is surreptitiously passed on to other computers online or through the exchange of memory disks. Introduced by piggybacking onto legitimate programs or messages, they are generally intended to cause damage by destroying data or overloading computer systems. They can be designed to act immediately, or set to operate at a given time.

<sup>15</sup>See John D. McAfee, "Managing the Virus Threat," *Computerworld*, Feb. 13, 1988, p. 89.

<sup>16</sup>For accounts of this incident, see Tony Fainberg, "The Night the Network Failed," *New Scientist*, vol. 121, No. 1654, Mar. 4, 1989, pp. 48-42; Philip J. Hiltz, "Virus Hits Vast Computer Network," *The Washington Post*, Nov. 4, 1988, pp. A-1, A-4. For a discussion of the impact on networks, see Jackson, op. cit., footnote 2, pp. 1, 74-75.

Addressing security problems is also complicated by rapidly changing technologies. New technologies bring with them novel, and often unforeseen, security problems. For example, when voice mail began to be widely deployed, hackers quickly discovered ways of using this technology to tap long-distance telephone lines.<sup>17</sup> Questions are now being raised about how the introduction of integrated services digital networks (ISDN) will affect the security requirements of present and future networks.<sup>18</sup> In addition, with the increased use of cellular radio for data transmission and facsimile calls, there is increasing concern about the security risks entailed in the use of these technologies.<sup>19</sup>

The convergence of computer and telecommunication technologies also gives rise to problems of contingency planning because the requirements for the two systems are quite different. Moreover, security personnel for computers and telecommunication differ greatly on what they see as the major security problems and safeguards. Because there is no consensus in government or in the private sector as to whether computer managers or network managers should be responsible for information security, effective security arrangements are often hindered by political turf battles, uncoordinated activity, and lapses in security coverage.<sup>20</sup>

**Factor 3: An increase in the complexity, decentralization, and interdependence of communication systems and, hence, in the difficulty of coordinating them to achieve security or survivability goals.**

Increases in computing power and decentralization of computing functions have increased the vulnerability of computer and communication systems to unauthorized use. Early systems were designed to be used by trained operators in reasonably controlled work environments; therefore, only local access to systems was of concern. Today's

**Figure 10-4-Four Stages of Viral Infection of Computer Systems**

There are four stages of viral infection

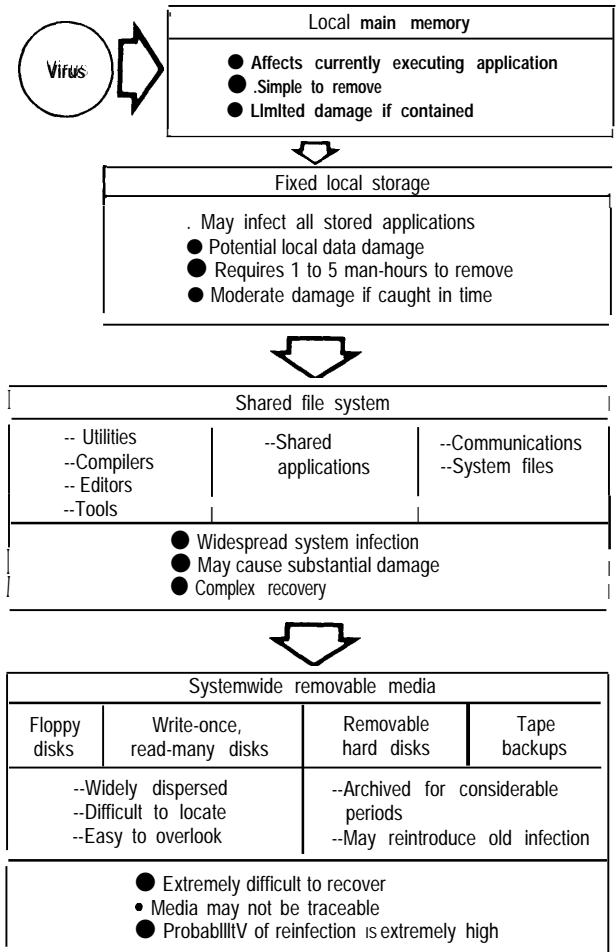

SOURCE: Copyright 1989 by CW Publishing inc., Frammgham, MA01701. Reprinted with permission from *Computerworld*, vol. 23, No. 6, Feb. 13, 1989, p. 91.

<sup>17</sup>See, for a discussion, John Burgess, "Hackers Find New Way To Tap Long Distance Lines," *The Washington Post*, Oct. 6, 1988, p. F-1.

<sup>18</sup>A recent report by Coopers & Lybrand, "The Security of Network Systems," concludes, for example, that: "in view of the changing environment and the importance of network system security, increased emphasis should be given to security within ISDN." As cited in Clare Lees, "Security: A Management Issue," *Telecommunications*, February 1989, p. 37. On the other hand, it has been suggested that the out-of-band signaling on the D channel is a major security feature of ISDN, making it easier to audit and authenticate user identification through the network. See, for a discussion, James Sherman and William Demlow, "ISDN: A Telecom Security Blanket," *Telephony*, Mar. 6, 1989, pp. 33, 35.

<sup>19</sup>See Nick Vafiadis, "Cellular Radio: Vulnerable to Attack," *Telecommunications*, February 1989, pp. 55-56.

<sup>20</sup>Sanford Sherizen, "Federal Computers and Telecommunications: Security and Reliability Considerations and Computer Crime Legislative Options," OTA contractor report, February 1985.

systems, on the other hand, are designed for maximum use—that is, to be used by anyone, anywhere.<sup>21</sup> One measure of this kind of security problem, for example, is the rapid proliferation of local area networks (LANs), whose market was estimated to grow from \$2.6 billion in 1987 to \$4.2 billion in 1988.<sup>22</sup> Moreover, according to one market research company, by 1992, 35 percent of all personal computers (PCs) sold will be networked, and 50 to 60 percent of all new PCs acquired by Fortune 1000 companies will be connected to LANs.<sup>23</sup> Characterizing the problems of control that this spread of LANs is likely to generate, one observer has said:

Once stand-alone personal computer users are given access to a local-area network, controlling them is like trying to corral fish within a public fence.<sup>24</sup>

The increased concentration of data in fewer and fewer facilities also makes communication systems more vulnerable to breaches in security. When operating a T3 network (circuits that operate at 44.736 megabits per second), network recovery is critical. The T3 signal is capable of transporting a total of 672 voice channels at 64 kilobits per second each; few networks could handle a simultaneous loss of 672 circuits. And high-capacity digital switches can connect and process more than a million calls in a single hour. As the executive vice-president of Contel has described it: “The network is getting thinner and thinner, and switches are getting bigger and bigger.”<sup>25</sup> Given this ability of optical fibers and electronic switches to handle vast quantities of data through fewer and fewer facilities, the number of

people affected by a system failure will be much greater than ever before.<sup>26</sup>

These technological complexities are compounded by organizational ones. Organizations frequently fail to make the important decision of who will control information, and where within the organizational structure the responsibility for such control will reside. These organizational problems are likely to increase, moreover, to the extent that businesses employ new communication technologies to expand the scope of their operations. More often than not, technologies are deployed without consideration of their security implications.<sup>27</sup>

#### **Factor 4: A growing divergence in stakeholder needs for security and reliability.**

Although virtually all users are concerned about some combination of confidentiality, integrity, and continuity of service, government agencies and the business community often have very different outlooks and needs when it comes to safeguarding information in computer and communication systems. Business-users have tended to consolidate their requirements for common information safeguards through voluntary participation in the activities of U.S. and international organizations that develop open public standards.<sup>28</sup> In contrast, the National Security Agency (NSA) sets its own standards in a process that is sometimes open to the public (e.g., computer security) and sometimes not (e.g., communication security).

These and other differences raise the question of whether information safeguards designed by and for the defense and intelligence agencies are well suited

<sup>21</sup>Based on the growth of networking, the market research company, Frost & Sullivan, has estimated that the overall market for computer security would jump from \$588 million in 1988 to \$1 billion by 1993. See Kelly Jackson, “Virus Fosters Growth in Sales of Security Products,” *CommunicationsWeek*, Nov. 21, 1988, p. 16.

<sup>22</sup>See, for one discussion, Michael I. Sobol, “Security Concerns in a Local Area Network Environment,” *Telecommunications*, March 1988, pp. 96, 98-99.

<sup>23</sup>This estimate was made by Forrester Research, Inc., and reported in Marc Cecere, “Backdoor Lans: How to Manage Unsanctioned Networks,” *Computerworld*, Nov. 2, 1988, p. 31.

<sup>24</sup>Ibid.

<sup>25</sup>As quoted in *ibid.*, p. 9.

<sup>26</sup>Ellen Block and Henry D. Levine, “Protecting the Last Mile: The Quest for a Robust Local Exchange Network,” *Telematics*, vol. 5, No. 10, October 1988, p. 9.

<sup>27</sup>See Lees, *op. cit.*, footnote 18, pp. 37, 38, 40-42.

<sup>28</sup>Recently, for example, the Corporation for Open Systems (COS) has been giving thought to the idea of establishing a special task force to develop network security standards. The task force would review current and future security efforts and make recommendations to the American National Standards Institute. In addition, it would seek to encourage vendors to provide products meeting these standards. See Kelly Jackson, “COS Is Getting Serious About Network Security,” *CommunicationsWeek*, Feb. 6, 1989, pp. 34-35.

to the needs of commercial and other users. As noted by Albert Belisle, the banking community, for one, is becoming increasingly concerned about:

... the move to protect all sensitive information in the same manner--business information, information of importance to the national interest, and classified defense information. Within both the public and private sectors, there is a need for a broad spectrum of information systems security standards, techniques, and tools. There must be a range of security "solutions" that can be matched to the value of the information being protected, and the nature of the threats. Outside of the classified and national security arenas, both the private and public sectors must select cost-effective security measures.<sup>29</sup>

Some citizens' groups have also questioned the level of security required by government for some types of information and communication activities. Responding to the President's National Security Decision Directive 145,<sup>30</sup> in September 1984, the American Civil Liberties Union expressed the fear that such measures went too far, and could be used to deprive individuals of access to the information they need to perform effectively as citizens.<sup>31</sup>

Given these divergent security needs, questions arise with respect to how much security should be provided in the public network, how its costs should be determined, and how it should be paid for. In the past, these costs were generally included in the regulated common carrier's rate base. It is not clear,

however, how they will be allocated in the future. Some have suggested, for example, that the Department of Defense (DoD) might provide direct funding for system upgrades.<sup>32</sup> In the State of New York, large users have been negotiating with NYNEX to provide greater redundancy in the public network. Elsewhere, other businesses have been informed by telephone company managers that, although technically feasible, the cost of such security measures would be too high. As one telephone company manager characterized it: "There is nothing we can't do; there are only things that you can't afford."<sup>33</sup> Competitors of local exchange carriers argue, moreover, that the best way to provide for a reliable, secure communication infrastructure is to promote competition at the local level.<sup>34</sup>

***Factor 5: An increase in the number of people who have access to communication systems and who are knowledgeable about their use, occurring at a time when there is no consensus about the legitimate use of the technology.***

As more and more people have gained access to communication and information-based systems, the problems of piracy and unauthorized use have mounted alarmingly.<sup>35</sup> These occurrences range from those that might be characterized as "benign mischief" to those that clearly constitute serious

<sup>29</sup>Albert R. Belisle, Vice Chairman of the American Bankers Association's Information Systems Security Management Committee, testimony at hearings on military and civilian control of computer security issues, before the House Committee on Government Operations, Subcommittee on Legislation and National Security, May 4, 1989. For a perspective that posits a more complementary relationship between business and defense needs, see Ashton B. Carter, "Telecommunications Policy and U.S. National Security," in Robert W. Crandall and Kenneth Flamm (eds.), *Changing the Rules Technological Change, International Competition, and Regulation in Communications* (Washington, DC: The Brookings Institution, 1989).

<sup>30</sup>This directive provided NSA with responsibility to secure, "by such means as are necessary," all government, military, and civilian computer and telephone systems that handle classified information, as well as "other sensitive" information, the loss of which "could adversely affect national security interests."

<sup>31</sup>Nathan Weber, "Telecommunications Crime," *Board*, vol. XXIII, No. 2, February 1986, p. 21. See also Steven L. Katz, "National Security Controls, Information, and Communications in the United States," *Government Information Quarterly*, vol. 4, No. 63, 1987; John Shattuck and Muriel Morisey Spence, "The Dangers of Information Control," *Technology Review*, vol. 91, No. 3, April 1988, pp. 62-73.

<sup>32</sup>Carter, *op. cit.*, footnote 29, p. 224. As Caner notes: "A precedent exists in the Civil Reserve Air Fleet program, where the department pays commercial airlines to modify the floors and doors of large aircraft so they can supplement military airlift in wartime."

<sup>33</sup>Block and Levine, *op. cit.*, footnote 26, p. 10.

<sup>34</sup>For example, as Robert Atkinson, Vice president of regulatory and external affairs for Teleport Communications, New York, has noted: "The lesson of Hinsdale is that instead of paying lip service to competition, regulators and legislators must start developing affirmative policies to encourage local competition. The issue is not how the Bell system companies can be unleashed, but instead how their bottleneck over the local communications network can be loosened enough so that a Hinsdale catastrophe will not happen again. Both the public sector and private sector have a role to play in insuring the basic integrity of the nation's telecommunication network." Robert Atkinson, "Where in the Blazes is Security?" *CommunicationsWeek*, Aug. 8, 1988, p. 8.

<sup>35</sup>For some recent cases, see John Burgess, "Hackers Find New Way To Tap Long-Distance Phone Lines," *The Washington Post*, Oct. 6, 1988, p. F-1; Christine Winter, "Legislators Alerted to Computer Virus Danger," *The Washington Post*, Oct. 14, 1988, p. F-1; and Lisa Stein, "The Intrigue and Art of Hobbling the Hackers," *Cablevision*, Sept. 12, 1988, p. 34.

computer crimes. Moreover, these activities appear to feed on themselves; what begins as a prank by one person is later refined into a more destructive or criminal form by another. As communication systems become more user-friendly and more interoperable, these problems are likely to multiply.

One factor underlying the growth of computer “hacking” is the lack of an agreed-upon ethic about the use of new technologies.<sup>36</sup> In fact, many of those using new technologies today share the view that some “computer crimes,” such as unauthorized entry to a private computer system or the use of illegal decoders, are less than serious.

## STRATEGIES AND OPTIONS

To address these problems, Congress can pursue six basic strategies. It can:

1. undertake further study and analysis of the changing security and survivability needs of the communication infrastructure;
2. facilitate the transfer of information about security and survivability, garnered in public agencies, to the private sector;
3. establish security and survivability standards for key industrial sectors;
4. provide special emergency facilities for private sector use;
5. improve coordination of survivability planning; and
6. increase activity geared to preventing security breaches.

These strategies, and the potential options that Congress might adopt to carry them out, are discussed below and summarized in figure 10-5.

### **Strategy 1: Undertake further study and analysis of the changing security and survivability needs of the communication infrastructure.**

*Option A: Continue funding and support for the National Research Council (NRC) to evaluate the state of reliability of the U.S. communication*

*infrastructure for purposes of national security and emergency preparedness.*

In 1983, the Defense Communications Agency (DCA), acting on behalf of the National Communications System (NCS), commissioned NRC to address the main problems then confronting National Security/Emergency Preparedness (NS/EP) telecommunication provision, and make recommendations. In the next 4 years, four reports were issued that collectively focused on the paramount need for telecommunication survivability. Acknowledging the fluidity of the telecommunication market—within which the motivating forces had become the emerging technologies, open competitive opportunities, and new commercial studies—the NRC reports clearly recommended that NCS and DCA should take stronger initiatives to influence both the market and new technologies that were in the interests of national security and emergency preparedness. For example, suggestions were made that electromagnetic pulse-resistant and radiation-hardened designs should be encouraged in NS/EP-dependent facilities. or even made mandatory; fiber optic cables should be specified wherever possible; fault-tolerant systems should be employed; and software for use in switching should be expanded to meet NS/EP priority capabilities. Emphasis was also placed on standardization and the need for common practices to assist and enhance network-to-network interface interoperability and common channel interoffice signaling.<sup>37</sup>

A fifth report, issued in May 1989, examines how society’s greater reliance on information increases the vulnerability of the Nation’s communication infrastructure. It concludes:

Already there are disturbing signs of increased vulnerability of the public networks to disruptions . . . The social and economic consequences of serious outages can only increase in a society which becomes daily more reliant upon information transfer services for smooth functioning.<sup>38</sup>

External evaluations of this kind are critical because,

<sup>36</sup>Steven Levy, *Hackers: Heroes of the Computer Revolution* (Garden City, NY: Anchor Press/ Doubleday, 1984). As the author points out, hacking originally occurred among computer science buffs, and it was a practice that actually gave rise to a number of technological advancements in the field. This original role has given a somewhat ambiguous meaning to the term “hacker.” and even to the whole concept of “hacking.”

<sup>37</sup>Edmonds, op. cit., footnote 7, p. 43.

<sup>38</sup>National Research Council, *Growing Vulnerability of the Public Switched Networks: Implications for National Security Emergency Preparedness* (Washington, DC: National Academy Press, 1989).

**Figure 10-5--Congressional Strategies and Options To Address Security/Survivability of the Communication Infrastructure**

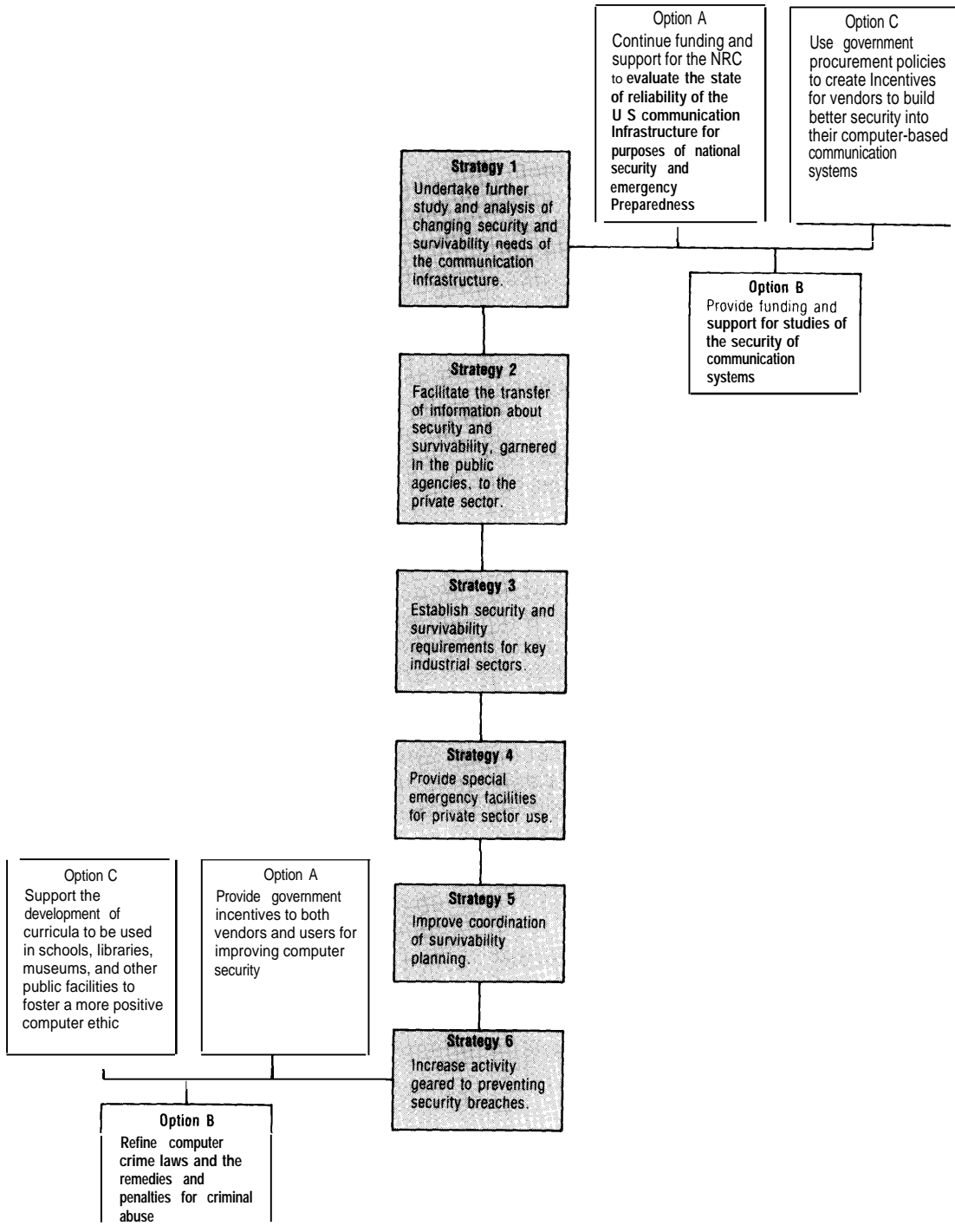

SOURCE: Office of Technology Assessment, 1990.

short of an emergency, there is no secure way to test the system's reliability.

*Option B: Provide funding and support for studies of the security of communication systems.*

Although events such as the fire in Hinsdale, Illinois, and the paralysis created among thousands of computer systems due to the spread of a powerful computer virus have recently highlighted the problems of security and survivability, very little hard data exist on the extent to which the private sector has experienced these problems. This lack of data is due in part to the business community's reluctance to make this kind of information public. Many business leaders fear that doing so would not only increase the problem by challenging others to engage in similar activities, but would also undermine their credibility with their customers.<sup>39</sup>

Although the private sector is not inclined to undertake a broad investigation of the scope of security and survivability problems, it may be in the government's interest to do so. As discussed in chapter 5, the economy is becoming increasingly dependent on information-based industries whose continued operation is dependent on the security and survivability of their computer-based communication systems. For example, in November 1985, a computer problem in the offices of the Bank of New York prevented it from completing an exchange of government securities. This fault in the system not only cost the bank \$1.5 million after taxes, but it also forced it to borrow \$24 billion from the Federal Reserve System.<sup>40</sup> A major fault in a telephone company computer system would be even more problematic; it might affect many more businesses and last for days, not hours.

Without better information about the extent of the security/survivability problem in the private sector.

the government will not have an adequate basis for choosing appropriate courses of action. Hence, this option would be a prerequisite for the more proactive options discussed below.

*Option C: Use government procurement policies to create incentives for vendors to build better security into their computer-based communication systems.*

The Federal Government is the largest buyer of computers and computer equipment in the United States. The FTS 2000 contract alone, for example, is valued at between \$3 billion and \$15 billion. Moreover, government's purchase of the UNIX operating system (with two-thirds of it going to defense) amounted to \$1.93 billion in 1988.<sup>41</sup> This kind of market leverage provides a way for the government to foster secure communication system: by structuring government procurement policies in ways that will induce vendors to enhance the security of their products.<sup>42</sup> Recently, for example, DoD issued Directive 5200.28, which requires that, by 1992, all multicomputer systems meet a minimum of C-level security standards. The C-level standard calls for need-to-know protection, audit compatibility, and user accountability.<sup>43</sup> Moreover, NSA's Secure Data Network Systems Project (SDNS) has been working for over 2 years to develop open systems interconnection (OSI)-based security standards. In addition, government regulations sometimes require firms with Federal contracts to have contingency plans for reliable communication services.<sup>44</sup>

Vendors are likely to be responsive to such incentives. To participate in SDNS, for example, vendors must agree to produce products based on protocols developed through the program.<sup>45</sup> Moreover, as products become more standardized, vendors have been trying to differentiate their wares,

<sup>39</sup>For one discussion, see John Foley and Jennifer Samuel, "Users Ponder Net security," *CommunicationsWeek*, Nov. 14, 1988, pp. 1, 74-75. According to Foley and Samuel, users refuse to discuss the security of their communication systems, fearing that public knowledge of their systems could leave them open to intrusion.

<sup>40</sup>Block and Levine, op. cit., footnote 26, pp. 9-12.

<sup>41</sup>Sherizen and Engle, op. cit., footnote 2, p. 92.

<sup>42</sup>For a discussion, see George Jelen, *Information Security: An Elusive Goal* (Cambridge, MA: Harvard University, Program on Information Resources Policy, Center for Information Policy Research, 1985), especially ch. 10.

<sup>43</sup>Mitch Betts, "Secure UNIX Aimed at Fed Deals," *Computerworld*, Nov. 7, 1988, pp. 23,25.

<sup>44</sup>James Daley, "Disaster Recovery To Hit Big Time, Study Says," *Computerworld*, Apr. 17, 1989, p.21.

<sup>45</sup>A number of major vendors are participating, including AT&T, BBN Communications, Digital Equipment Corp., GTE Corp., Honeywell Inc., IBM, Motorola Corp., Unisys Corp., Wang Laboratories, Inc., and Xerox Corp. See Jackson, op. cit., footnote 28, p. 35.



and security features represent one way of doing this.<sup>46</sup> However, one limitation to this option is the lack of well-developed procurement standards within government agencies.

**Strategy 2: Facilitate the transfer of information about security and survivability, garnered in public agencies, to the private sector.**

The Computer Security Act of 1987 assigns to the National Institute of Standards and Technology (NIST) the responsibility for developing technical, management, physical, and administrative standards and guidelines for security of sensitive information in Federal computer systems. The act requires, moreover, that each Federal agency provide mandatory periodic computer security training for employees involved in the management, use, or operation of Federal computer systems within, or under the supervision of, that agency.

Given the wisdom and experience gained by establishing security standards and secure information practices in the public sector, the Federal Government might want to develop more systematic ways of sharing this knowledge with the private sector. For example, NIST might enhance its programs to certify vendors, transfer technology, standardize designs, procure devices, and encourage the development and use of improved safeguards.<sup>47</sup> Closer cooperation between NIST and the private sector in security-related matters would also allow the government to benefit from innovations and new technologies developed in the private sector. One step that NIST has already taken in this regard is to set up a program for bringing together government organizations and private contractors interested in interoperability and security in the OSI computer network architecture and the ISDN computer architecture. The fundamental objectives of this program are to:

- develop demonstration prototypes of applications and equipment, including hardware and software, that provide one or more levels of security in an OSI and/or ISDN environment;
- develop data formats, protocols, interfaces, and support systems for security in an OSI/ISDN environment that can be used as a basis for Federal information-processing standards. Such standards may then be used as bases for Federal procurement of services and systems in the future; and
- provide a laboratory in which users, developers, and vendors can jointly define, develop, and test systems that will provide a range of telecommunication, network management, and security services in a distributed information-processing environment.

In addition, DoD's Advanced Research Project has recently created the Computer Emergency Response Team (CERT), which is designed to act as a central clearinghouse for information concerning the detection of viruses. It will also distribute solutions, as they become available, to those who have been affected. Its members include staff from the Federal Bureau of Investigation, as well as other technical and management experts. CERT is located in the Software Engineering Institute, Carnegie-Mellon University.<sup>48</sup>

The major problem involved in the sharing of security information between government and the private sector stems from the role that security plays in intelligence and defense. Whereas businesses are accustomed to working out criteria and standards in open processes, the defense community is typically more secretive. Moreover, as the OTA assessment, *Defending Secrets, Sharing Data*,<sup>49</sup> points out, this conflict of interest is exacerbated by the fact that the law fails to clearly delineate between the responsi-

<sup>46</sup>Betts, op. cit., footnote 43.

<sup>47</sup> Since the early 1970s, NIST has conducted a laboratory-based computer security program to develop cost-effective solutions for protecting reclassified information. These solutions are made available to Federal and private organizations through the development and publication of standards, guidelines, and other technical documents; sponsorship of conferences and workshops; and other technology-transfer activities. The fiscal year 1990 budget submission to Congress proposes a NIST research program that provides for activities such as laboratory-based research, the development of cost-effective management and technical security methods and solutions, leadership in developing national and international information security standards, encouragement and facilitation of technology transfer, and development of materials to support security awareness and training.

<sup>48</sup>Chris Roeckl, "User Organizations Offer 'Virus' prescription," *CommunicationsWeek*, Jan. 16, 1989, p. 24.

@Office of Technology Assessment, *Defending Secrets, Sharing Data*, Op. cit., footnote 4.

bilities of NIST and NSA in this area.<sup>50</sup> One way of encouraging private-public cooperation on security issues, therefore, would be for Congress to clearly separate the responsibilities between NIST and NSA, based on defense considerations.<sup>51</sup>

An additional constraint on the development of this option might be the limited budget and lack of personnel that are available to NIST to handle this task. The Reagan Administration budget, which the Bush Administration adopted with only minor exceptions, proposed a reduction in NIST's budget from \$158 million in 1989 to \$153 million in 1990.<sup>52</sup> This reduction was budgeted, moreover, even though in the past NIST has had to contract out to NSA much of its broad research on security standards.<sup>53</sup> Moreover, a recent study by the General Accounting Office found that NIST has been slow to implement the Computer Security Act, insofar as 21 agencies reported that, as yet, they did not have security training programs in place.<sup>54</sup> Given this lack of progress in developing technical standards and common procedures, many are concerned that the limited funds available to NIST might prevent it from carrying out its responsibility in this area. Testifying recently at *Hearings on Military and Civilian Control of Computer Security Issues*, before the House Committee on Government Operations, a spokesperson for the Information Industry Association, noted, for example:

We believe that NIST is underfunded. It has insufficient resources to expeditiously carry out its mission under [the Computer Security Act of 1987]. This resulted, for example, in NIST falling behind its own schedule for completion of reviews of agency

security plans, even though the agency has the assistance of NSA in this task.<sup>55</sup>

### Strategy 3: Establish security and survivability, requirements for key industrial sectors.

Given the increased dependence of many corporations on communication and information-based systems, Congress could identify businesses whose continued functioning is critical to society, and establish guidelines or requirements for making their communication facilities secure. As a result of the destruction caused by a telecommunication cable fire in Tokyo, for example, the Japanese Government considered ways of establishing safety and reliability standards, as well as the means of implementing them. They mandated technical improvements, including increased redundancy of critical circuits and better fire-prevention designs; designated some users whose service should be restored on a priority basis in case of disruption; and instigated studies of the need for improved damage compensation and insurance schemes for communication-related accidents.<sup>56</sup>

There is a U.S. precedent for such an approach. Since 1983, for example, the Office of the Comptroller of the Currency has mandated that all national banks undertake contingency planning for key operational areas, which now include microcomputers.<sup>57</sup> In accordance with these rules, the bank's management will be held accountable for the failure to develop a sound plan.

In general, businesses have been slow to adopt security measures or to prepare for emergencies,

<sup>50</sup>Notwithstanding the provisions of the Computer Security Act, NSDD-145 has assigned similar responsibilities to NSA, which is charged with reviewing and approving all standards, techniques, systems, and equipment for telecommunication and automated information systems security. The relationship between NIST and NSA was the subject of oversight hearings before the House Committee on Government Operations, *Hearings on Military and Civilian Control of Computer Security Issues*, May 4, 1989.

<sup>51</sup>Options for reorganizing the responsibilities of NIST and NSA in this area are analyzed in Office of Technology Assessment, *Defending Secrets, Sharing Data*, op. cit., footnote 4.

<sup>52</sup>Daniel S. Greenberg, *Engineering Times*, April 1989, p. 3.

<sup>53</sup>For a discussion, see statement of Lance J. Hoffman, Professor of Engineering and Applied Science, Department of Electrical Engineering and Computer Science, The George Washington University, hearings, op. cit., footnote 29.

<sup>54</sup>U.S. Congress, General Accounting Office, *Computer Security: Compliance With Training Requirements of the Computer Security Act of 1987* (Washington, DC: U.S. General Accounting Office, February 1989), p. 17.

<sup>55</sup>Kenneth B. Allen, Senior Vice President, Government Relations, Information Industry Association, hearings, op. cit., footnote 29. See also statement of Miriam A. Drake, Dean and Director of Libraries, The Georgia Institute of Technology, on behalf of the American Library Association and the Association of Research Libraries, *ibid*.

<sup>56</sup>Naruko Takanashi et al., "The Achilles' Heel of the Information Society: Socioeconomic Impacts of the Telecommunication Cable Fire in the Setagaya Telephone Office, Tokyo," *Technological Forecasting and Social Change*, vol. 34, No. 1, August 1988, pp. 27-52.

<sup>57</sup>Sanford Sherizen and Albert Belisle, "Begin Contingency Planning Or You Might Become an Outlaw," *Computerworld*, July 11, 1988, p. S-10.

often postponing action until after a problem has occurred. For example, in a recent survey of users, it was found that only 17 percent of Fortune 1000 sites were protected by encryption or call-back.<sup>58</sup> One major reason cited for the failure to use such systems is cost.<sup>59</sup> Thus, many businessmen are likely to be opposed to the government setting security/survivability standards or preparedness requirements on the grounds that such action would constitute undue interference in the affairs of the private sector.<sup>60</sup> And many would be concerned that, with standardized security practices, they themselves might be held liable if something were to go wrong. This is not an idle concern. As Sherizen and Belisle have pointed out:

There are already an increasing number of laws defining acceptable business practices. Legal attention will soon be paid for failure to survive a major business interruption, which will be considered a malfeasance of duty.<sup>61</sup>

Others might contend that the market will take care of the problem. In this view, the decision to protect against risks is a matter of business strategy; when businesses experience the increased costs entailed in communication failures, they will proceed quickly to resolve their own security problems. Already there is evidence of a growing market for security products. A recent survey conducted by Frost and Sullivan Inc., for example, predicts that the market for computer security will be \$1 billion by 1993.<sup>62</sup>

On the other hand, as noted above, businesses have generally been slow to respond to security threats. And they may be particularly reluctant to invest in communication security because its value

has to be traded off not only against cost, but also against system access and interoperability.

#### **Strategy 4: Provide special emergency facilities for private-sector use.**

If the two New York Telephone switching centers were to fail, among those affected would be many of the world's largest financial institutions, including the Federal Reserve Bank, domestic and international banks, investment banking firms, stock exchanges, and large corporations.<sup>63</sup> Given their increased dependence on computer-based communication, many such companies are investing heavily to protect against natural or manmade failures in their networks. Some have called for redundant central offices, for which they would be willing to pay a considerable fee. Others are taking out special insurance policies and contacting for redundant processing capacity, known as "hot spots," to be used on an emergency basis. At a cost of approximately \$50,000 per month, this option is clearly not available to all businesses.<sup>64</sup>

To the extent that the ability to pay for such protection is not correlated with a company's strategic value to the government or to the economy, the government may want to make special provisions to assist in some emergencies. One way would be to allow some private companies to make temporary use of the Nationwide Emergency Telecommunications Service (NETS).<sup>65</sup> At present, this service is available only for 20,000 authorized Federal Government users.

Members of the defense community would likely be opposed to such an option, given the need to keep the system secure and available for defense-related emergencies. Moreover, setting rules and proce-

<sup>58</sup>Survey conducted for *CommunicationsWeek* by Computer Intelligence Corp., as cited in Foley and Samuel, *op. cit.*, footnote 39, p. 75.

<sup>59</sup>*Ibid.* Experts estimate that security measures make up about 10 to 20 percent of the overhead costs of networks.

<sup>60</sup>This was, in fact, a point emphasized by the American Petroleum Institute in its review of the OTA draft, as well as a point stressed by Albert R. Belisle in his testimony on behalf of the American Bankers Association, *Hearings*, *op. cit.*, footnote 29, May 4, 1989.

<sup>61</sup>Sherizen and Belisle, *op. cit.*, footnote 57.

<sup>62</sup>Jackson, *op. cit.*, footnote 21; see also Clinton Wilder, "Cashing In On Virus Anxieties," *Computerworld*, Nov. 21, 1988, pp. 1, 6.

<sup>63</sup>Foley, *op. cit.*, footnote 12. See also U.S. Congress, Office Of Technology Assessment, "Information Technology and Securities Markets," in progress.

@For a discussion, see James Daly, "Electronic Vaulting Catches On," *Computerworld*, Dec 19, 1988, pp. 21, 26; and James Daly, "Comdisco Unrives Disaster Recovery Hot Site To Go," *Computerworld*, Nov. 28, 1988, p. 18.

<sup>65</sup>As described by the National Research Council, NETS is "... one of three programs that will provide telecommunications capabilities as required by Presidential Order in National Security Decision Directive (NSDD) 97. . . . These programs are designed to meet current and future requirements of the federal government for national security and emergency preparedness telecommunications. NETS is the largest of the three programs and is intended to provide survivable, switched, voice, and data service."

dures for access might be very difficult. However, using the service for business-related emergencies might have some positive defense benefits; it would provide greater information about how well the system works in an actual emergency. The arrangement for use by businesses might be worked out and authorized through the Federal Emergency Management Agency.

### **Strategy 5: Improve coordination of survivability planning.**

In evaluating the policy planning environment of national security telecommunication, NRC, in its 1986 report to DCA, called for a "bottom up" response to emergency situations, and stressed the need for improved coordination with, and assistance from, State and local governments. NRC also called for better coordination among providers of communication services.<sup>66</sup>

The delayed response to the Hinsdale fire suggests that additional improvements can be made in the planning and coordination of emergency response measures. Reportedly, the response time after the switch failed was 10 hours, the delay being due, in part, to the need for verifying the request for assistance.<sup>67</sup> Moreover, as described in chapter 13, State approaches to telecommunication policy are, in fact, becoming less uniform, making coordination with them more difficult. Some States, for example, having greater concentrations of businesses, may have more incentive for promoting the reliability of communication systems than do other States. Also compounding the coordination problem is the failure of telecommunication vendors to agree on common standards, as well as the continued migration of many businesses from the public switched network to their own private networks. In addition, the

impact of the open network architecture process and the move towards an intelligent network with common channel signaling will need to be assessed in terms of security criteria.<sup>68</sup>

### **Strategy 6: Increase activity geared to preventing security breaches.**

*Option A: Provide government incentives to both vendors and users for improving computer security.*

As Robert Morris, chief scientist at NSA, has noted: "To a good approximation, every computer in the world is connected to every other computer."<sup>69</sup> In this sense, a network's security is no greater than its weakest link. For example, over a period of 5 years, a person in London was able to employ a computer network to break into more than 200 military, corporate, and university computer systems in Europe and the United States.<sup>70</sup> And a network can serve as a "conduit for infection," proliferating computer viruses.<sup>71</sup>

As already noted, despite these interdependencies and the greater risks that they entail, many users continue to ignore security issues. Under these circumstances, where the negligence of some may have a considerable negative impact on others, Congress might want to provide incentives to induce both vendors and users alike to adopt greater security measures. As in the case of energy efficiency, such incentives might take the form of tax credits. Developing the appropriate incentives, however, will require a greater understanding than we now have about the incentives that lead corporate management to adopt security measures.<sup>72</sup> It may be necessary, moreover, for government to help de-

<sup>66</sup>"Policy Planning Environment for National Security Telecommunications," final report to the National Communication System, National Research Council, Washington, DC, July 1986.

<sup>67</sup>Personal communication with Martin Edmonds, OTA contractor, Nov. 8, 1988.

<sup>68</sup>In one recent report, NRC points out how common channel signaling, which is a characteristic of the intelligent network, will make nationwide emergency telecommunication service more vulnerable. "Interim Report to the National Communication System," August 1988.

<sup>69</sup>"The Complexity of Computer Security," *Science News*, vol. 134, No. 13, Sept. 24, 1988, p. 199.

<sup>70</sup>John Markoff, "Briton Said To Penetrate U.S. Computers," *The New York Times*, Oct. 24, 1988, p. D-1.

<sup>71</sup>Boyce Rensberger, "Networks Are Conduits for the Infection," *The Washington Post*, Nov. 4, 1988, p. A-41.

<sup>72</sup>Senior management tends not to understand information security, since it seldom receives an evacuation in senior management terms. Consider, for example, the lack of incentives involved with the direct costs associated with improving information security. These costs include negative impact on organizational productivity, possible system degradation, unhappy and inconvenienced users, as well as the cost of the security product or device. Sanford Sherizen, personal communication, Mar. 27, 1989.

velop a better set of tools to help organizations determine security risks.<sup>73</sup>

*Option B: Refine computer crime laws and the remedies and penalties for criminal abuse.*

Computer crime and the ability to inflict damage on computer-based networks have increased significantly in the past several years, keeping pace with the increased access to and use of these electronic systems. The typical infringer is no longer a youthful “hacker” exploring an electronic environment, but rather an ordinary criminal—quite often an employee—using electronic technology as the tool of his or her trade.<sup>74</sup>

This growth in computer crime does not reflect a dearth of legislation prohibiting such behavior; there are now two Federal computer crime laws, and all but three States have adopted at least one.<sup>75</sup> These developments do reflect, however, a lack of consistency in the law, and a lack of agreement about penalties for infringement and remedies for the victims of computer crimes.<sup>76</sup> In the absence of a consensus about the nature of computer crime, it is not surprising that few cases go to trial, and those who are found guilty rarely receive prison sentences.<sup>77</sup> Therefore, Congress could define a more consistent set of communication/computer crime laws—together with a set of appropriate, comparable penalties—and establish a better way of handling evidential materials in computer-related cases.<sup>78</sup> To

execute such a policy, conflicts between Federal and State laws would have to be resolved.

*Option C: Support the development of curricula to be used in schools, libraries, museums, and other public facilities to foster a more positive computer ethic.*

The lack of agreement in the legal community about the nature of computer/communication-related crime mirrors a more general confusion about this issue in the community-at-large.<sup>79</sup> The absence of a positive ethic governing the use of computer and communication technologies is likely to have even more serious consequences in the future, when many more people will have access to, and become more accustomed to using, these new technologies. To help create such an ethic, Congress might support the development of a special curriculum to be used in schools, libraries, museums, and other public facilities. Ideally, such a curriculum would be available to children when they first come into contact with information and communication technologies. Since school curricula are developed by the States, the Federal Government’s role would have to be indirect, such as providing funding. One challenge in fostering an ethical code of behavior for the use of electronic technologies will be to preserve the youthful inclination to use technology to explore and make discoveries, while simultaneously teaching users to respect the rights of others.<sup>80</sup>

<sup>73</sup>Present risk analysis approaches are typically based on models that are not the most appropriate or useful for computer and telecommunication issues.

Ibid.

<sup>74</sup>J. J. Buck Bloombecker, “The Spread of Computer Crime,” *International Computer Law Adviser*, vol. 2, No. 8, May 1988, p. 4.

<sup>75</sup>In March 1989, Representative Wally Herger reintroduced a bill to combat computer viruses, which he first introduced in July 1988. HR 55 would make it a Federal crime to knowingly introduce into a computer network a virus or other computer program that causes loss, expense, or risk. In addition, the bill would also allow affected parties to file civil suits to recover damages. Whereas the earlier version of the bill was included in the Federal Code under the section dealing with malicious mischief, the new version is included under the section on computer crimes, and would thus provide for a stiffer 20-year maximum prison sentence for second offenders. Robert Midford, “Bill Expands Protection From Viruses,” *Federal Computer Week*, Mar. 20, 1989, pp. 20, 24.

<sup>76</sup>For a discussion of the problems entailed in specifying difficult concepts such as authorized activities, see Sherizen, op. cit., footnote 20.

<sup>77</sup>Ibid.

<sup>78</sup>John A.N. Lee, Gerald Segal, and Rosalie Steier, “Positive Alternatives: A Report on an ACM Panel on Hacking,” *Communications of the ACM*, April 1986, vol. 29, No. 4, pp. 297-230.

<sup>79</sup>Ethical issues surfaced again when the Internet network was broken into, as described above. See also Michael Alexander, “Security Ethics Under National Scrutiny,” *Computerworld*, Nov. 4, 1988, pp. 1, 6.

<sup>80</sup>For a discussion of this challenge, see Michael Specter, “Hackers’ Easy Ride,” *The Washington Post*, Nov. 11, 1988, p. A-1.

**Chapter 11**

# **Interoperability in the Communication Infrastructure**

# CONTENTS

INTRODUCTION .....	Page
THE PROBLEM .....	293
STRATEGIES AND OPTIONS .....	300
General Discussion of Strategies .....	300

## *Figures*

<i>Figure</i>	
11-1. ISDN Subscriber Loop Interface .....	Page 297
11-2. Congressional Strategies and Options to Address Interoperability/Coordination of the Communication Infrastructure .....	303
11-3. OSI Reference Model, .....	303

## *Tables*

<i>Table</i>	
11-1. Integrated Services Digital Network Factors Affecting the Choice of Federal Options .....	Page
11-2. Open Systems Interconnection Factors Affecting the Choice of Federal options .....	311
11-3. Open Network Architecture Factors Affecting the Choice of Federal Options .....	316
.....	321

# Chapter 11

## Interoperability in the Communication Infrastructure

---

### INTRODUCTION

Communication systems are, by definition, designed to interconnect. Thus interconnection, or interoperability, is a critical dimension of any communication infrastructure.<sup>1</sup> The more interoperable a communication system is, the more connections it can provide and the more accessible it will be to everyone on an equal basis. By creating economies of scale, interoperability can also reduce the costs of producing communication technologies, resulting in lower prices. Because new products and services that conform to known standards will be able to interconnect with existing systems, interoperability can foster product innovation. In addition, because interoperability permits redundancy, it can support the survivability of a system. Finally, interoperable communication systems support the flow of information, a critical feature in an information age.

Interoperability is important not only in a technical sense, but in an administrative sense as well. That is, to be most useful, the infrastructure needs to be transparent to users in terms of the technologies they use and the kinds of services offered, as well as the prices and rules that govern their use.

Interoperability also has a down side. By facilitating access, for example, it can make a communication system more vulnerable to breaches in security. Moreover, vulnerabilities in any one part of a system

can easily be transmitted to others (as witnessed recently with the spread of computer viruses). In addition, to the extent that interoperability requires standardization, it will limit diversity of choice.<sup>2</sup> Under some circumstances, standards may also retard innovation by acting as barriers to market entry or by inhibiting manufacturers and vendors from venturing forth with a new, but incompatible, product.<sup>3</sup>

### THE PROBLEM

In the past, achieving adequate interoperability within the communication infrastructure was relatively easy. In telephony, AT&T provided both end-to-end service and system interconnection. In mass media and information-processing technologies, the government played an important role, assuring, when necessary, that adequate standardization took place.<sup>4</sup>

However, OTA found that interoperability is likely to become more problematic in the future, from both technical and administrative standpoints. Not only will the need for interoperability become greater, but achieving it is also likely to be harder. Seven factors suggest such an outcome.

#### ***Factor 1: The growing importance of information and communication as strategic resources.***

Communication systems serve as an infrastructure that supports all social activities. Interoperabil-

---

<sup>1</sup>For some theoretical, economic discussions of interoperability and communication standards, see Stanley M. Besen and Garth Saloner, "Compatibility Standards and the Market for Telecommunications Services," The Rand Corp., February 1988; Stanley M. Besen and Leland L. Johnson, "Compatibility Standards, Competition, and Innovation in the Broadcast Industry," The Rand Corp., November 1986; Sanford V. Berg, "Technical Standards and Technological Change in the Telecommunication Industry," Public Utility Research Center, University of Florida, Gainesville, August 1988; Joseph Farrell and Garth Saloner, "Economic Issues in Standardization," Sloan School of Management, Massachusetts Institute of Technology, WP #1795-86, October 1985; and David Hack, "Telecommunications and Information-Systems Standardization-Is America Ready?" Library of Congress, Congressional Research Service, May 21, 1987. For a thorough characterization of standard-setting organizations and processes from an organizational/behavioralist point of view, see Carl F. Cargill, *Information Technology Standardization Theory, Process and Organizations* (Rockport, MA: Digital Press, 1989).

<sup>2</sup>Eli M. Noam, "The Political Economy of ISDN: European Network Integration vs American System Fragmentation," paper presented to the XIV Annual Telecommunications Policy Research Conference, Airlie, VA, April 1986.

<sup>3</sup>Joseph Farrell and Garth Saloner, "Standardization, Compatibility, and Innovation," *Rand Journal of Economics*, vol. 16, No. 1, Spring 1985, pp. 70-83; and Joseph Farrell and Garth Saloner, "Standardization and Variety," *Economic Letters*, January 1986, pp. 71-74.

<sup>4</sup>For example, both the Department of Defense and the General Services Administration played important roles in the standard-setting Process for COBOL, a computer language that allowed for program compatibility that was approved by the American National Standards Association (ANSI) in 1968. Berg, op. cit., footnote 1, p. 10.



ity is important, therefore, not only in terms of a system's technical characteristics, but also in terms of whether it can support social activities as well. In every realm of society, interoperability serves as a key factor in determining whether, and by whom, new opportunities afforded by information and communication technologies will be realized (see chs. 5, 6, 7, and 8). Therefore, in considering its role relative to setting standards for the U.S. communication infrastructure, the government increasingly will have to take into account the overall societal benefits of new technologies. For example, against the danger of retarding innovation by pressing prematurely for standards, the government will have to weigh not only potential losses in efficiency, but also the loss of both domestic and international business opportunities that might result from the lack of standards. In addition, in determining whether to play a more proactive role relative to standards, the government will need to balance the potential loss of diversity and customer choice that standardization brings against the problems of equity that might arise if users have to "purchase" interoperability as a commodity.

**Factor 2: The elimination of many of the traditional mechanisms by which interoperability has historically been achieved, and the emergence of new players.**

The divestiture of AT&T, the convergence of communication and information technologies, and deregulation have all served to undo many of the mechanisms used in the past to achieve interoperability in the U.S. communication infrastructure. Achieving interoperability was relatively easy because there were few stakeholders, and those who

were actively involved generally focused their attention on a circumscribed set of technologies. Today, this is no longer the case.

Before the divestiture of AT&T, for example, telecommunication standards were established by the Bell Telephone System, and they were based, for the most part, on a commonly accepted set of engineering criteria. As Horwitt has described it:

The market has changed since predivestiture days, when Ma Bell set telecommunication standards and other carrier and equipment vendors had no choice but to follow. Now AT&T is just one more vendor—albeit a formidable one—lobbying for industry-wide adoption of the technological protocols it wants to use.

With respect to long-distance carriers alone, instead of one service provider there are now a number of equipment providers, interexchange carriers, enhanced-service providers, service resellers, and private-line networks, all with a stake in standards issues. Divestiture also created the seven Regional Bell Operating Companies, each with a somewhat different business strategy and a distinct view of network standards.<sup>6</sup> Moreover, in the wake of divestiture, a number of companies have emerged to provide gateway, translator, and network management services.<sup>7</sup> Because their products can serve as substitutes for standards, they, too, have a very basic interest in issues involving interoperability and standards.

In addition, with the convergence of communication and computer technologies and their markets, computing companies have a large stake in communication standards, as do communication companies

<sup>5</sup>Elizabeth Horwitt, "protocols Don't Stand Alone," *Computerworld*, Oct. 20, 1986, p. 27.

<sup>6</sup>To facilitate the development of standards among the regional holding companies, the Exchange Carriers Standards Association (ECSA) was established at the time of divestiture. The ECSA T1 Committee on Telecommunications has been accredited by ANSI, and today is chiefly responsible for providing the telecommunication industry with an open public forum for developing interconnection, interoperability, and performance standards. Its 140 member organizations represent exchange carriers, interexchange carriers and resellers, manufacturers, and vendors, as well as users and general interest participants. For a detailed description see, A.M. Rutkowski, "The Exchange Carriers Standards Association," *Telecommunications*, January 1987, pp. 77-87.

<sup>7</sup>One area that has recently demonstrated tremendous growth is that of system integration. System integrators help organizations to develop communication systems comprised of an enormous variety of hardware, databases, and software, and to link them together in a seamless fashion. According to some analysts, the system integration business is growing at an annual rate of 20 percent, and its revenues are expected to increase from \$8 billion in 1987 to \$22 billion in 1993. For a discussion, see Mark Breibart, "Systems Integration Surge," *Computerworld Focus on integration*, a supplement to *Computerworld*, Feb. 6, 1989, pp. 29-33; see also, Mary Jo Foley, "Private Sector Systems Integration," *Datamation*, Dec. 1, 1987, pp. 77-79. Given the variety and complexity of the technology, it should be noted that the term "system integrator" is, itself, very confusing. As one trade journal analyst notes: "Talk to 40 different suppliers and you will get 40 different definitions, Specialist system integrators define it as a business for coordinating the elements of a customer solution. Vendors define it a dozen different ways, and many claim that they have been doing it all along and can't see what the fuss is about. Service firms define it as a service business. Software firms define it as a software business, Communication companies define it as a network business." Brian Jeffery, "The Drive for Integration," *Computerworld*, Sept. 7, 1988, pp. 15-17.

in computing standards. This was illustrated recently by the protracted battle among communication and information technology companies about how and by whom the next version of UNIX will be developed.<sup>8</sup> In these two arenas, the attitudes towards standards, the values placed on them, and the processes for achieving them have historically been somewhat distinct, raising questions about how these two cultures will reconcile their differences in the future.<sup>9</sup> As the technologies converge, there is also likely to be an increasing number of jurisdictional issues emerging among organizations, such as the International Standards Organization (ISO) and the Consultative Committee for International Telephone and Telegraph (CCITT), which traditionally have been responsible for the development of standards in a particular area.

There are new players in the administrative arena as well. With deregulation taking place at the Federal level, many States have begun to take a more assertive role in regulating communication (see ch. 4). With respect to standards, for example, many States have demonstrated their intent to be active participants in the open network architecture (ONA) process.<sup>10</sup> The States are also likely to have an interest in the development of Integrated Services Digital Networks (ISDN), especially with respect to how services are defined and whether or not they will be regulated. Foreign governments, all with their own objectives, are also becoming critical players in the standards-setting process.

***Factor 3: The globalization of the economy and, hence, a greater need for international standards and the extension of standards-setting efforts to the international arena.***

With the globalization of the economy, U.S. standards now have to be brought into line with international standards. As Ithiel de Sola Pool has pointed out:

Until now in the telecommunications field there have generally been two sets of standards, the CCITT standards of the International Telecommunications Union followed in most of the world and the Bell system standards which prevailed in America.<sup>11</sup>

Given the breakdown of geographic boundaries, American vendors now need to take international standards-setting processes and the entire world market into account when considering what standards should be adopted for the United States. Thus, although many American computer vendors and telecommunication carriers were reluctant to adopt the CCITT X.400 standard for electronic mail, they found that they needed to support it if they wanted to compete in the world market.<sup>12</sup> Similarly, although the Federal Communications Commission (FCC) was hesitant about setting standards for high definition television (HDTV), it found that it had to move the U.S. standards-setting process along, given that HDTV standards were being developed and adopted in other countries.<sup>13</sup> Two major sets of standards—for ISDN and open systems interconnection (OSI)—are presently being debated and discussed in international fora.<sup>14</sup>

The need for U.S. vendors to align their standards with those of the rest of the world will become even greater after 1992, when the nations of Europe merge into a unified economic market made up of approximately 620 million people. Fully cognizant of how standards can serve as barriers to trade, the European nations are trying to speed up their efforts to achieve

<sup>8</sup>See, for example, Christine Bonafield, "UNIX Split Gets Wider," *CommunicationsWeek*, Nov. 7, 1988, p. 1.

<sup>9</sup>As Besen and Saloner have pointed out, in the information industry, "standardization issues revolved mainly around the ability of manufacturers of peripheral equipment to connect their products to the Central Processing Units of other manufacturers. Since there were only a few mainframe manufacturers, and they provided integrated systems, and thus were not dependent upon the equipment of peripheral manufacturers, they had little incentive to ensure that interfaces were standardized." Besen and Saloner, op. cit., footnote 1, p. 18.

<sup>10</sup>Eli M. Noam, "Implementing ONA: Federal State Partnership Needed to Connect Network of Networks," *CommunicationsWeek*, May 2, 1988, p. 16.

<sup>11</sup>Ithiel de Sola Pool, "competition and Universal Service," Harry Shooshan (cd.), *Disconnecting Bell, The Impact of the AT&T Divestiture* (New York, NY: Pergamon Press, 1984), p. 119.

<sup>12</sup>Besen and Saloner, op. cit., footnote 1, p. 3.

<sup>13</sup>The FCC has decided that whatever HDTV broadcast standard is ultimately selected it must be compatible with existing TV sets and transmitters. Advanced Television Systems, MM Docket No. 87-268,65 R.R. 2d 295 (1988).

<sup>14</sup>These standards, and the issues to which they give rise, are discussed in detail later in the chapter.

regional standardization by the 1992 deadline.<sup>15</sup> To facilitate this process, the European Community established the European Telecommunications Standards Institute (ETSI) early in 1988. This independent body, financed by all of the postal, telegraph, and telephone authorities (PTTs) and major telecommunication suppliers, assumed responsibility for the standards' work that was previously carried out under the Conference of European Post and Telecommunications Administrations (CEPT). Moreover, in April 1989, 18 European countries signed a memorandum of understanding, which states that, effective immediately, those countries will provide a common range of basic services and a list of optional services that will be made available to common standards as demand develops.<sup>16</sup>

How international standards are resolved will affect not only U.S. trade, but also economic and technological developments in the United States. Without common standards, for example, it is not easy for U.S. users with international networks to transport their own company-standard equipment into *other* countries.<sup>17</sup>

The international process for setting standards also affects and is affected by U.S. regulatory policy, as the history of the debate over the "U" interface clearly illustrates. In ISDN standards, for example, the "S" "T" and "U" interfaces define the possible points at which customer premises equipment can link up with the national, public network (see figure 11-1). By picking the "U" interface, the U.S. Government provided the greatest leeway for competition within the customer-premises equipment market. The governments of Europe, who were less concerned about competition in the customer-premises equipment market, selected the "S" and "T" interfaces. These conflicting choices proved to be a matter of considerable contention in the process of establishing ISDN standards.<sup>18</sup>

#### **Factor 4: The increased politicization of standards-setting issues.**

A standard, as described by Sanford Berg, can be:

... a potentially private good whose ownership assignment is handled via technical committees. Just as the radio spectrum is a scarce good whose allocation affects the wealth of firms, assignment of points (or specification of a protocol) can give advantages to one firm.<sup>19</sup>

Once a standard has been set, for example, firms whose products are incompatible may no longer be able to compete. Thus, many firms may try to avoid having a standard adopted, unless their own products are likely to be favored. Users, on the other hand, generally welcome standards. With systems that are open or standardized, users have more market power vis a vis vendors. Not only can they mix and match the components of their communication systems, picking and choosing among different vendors; they can also migrate more easily to a new system, phasing out their older equipment more gradually and without disruption.<sup>20</sup> In addition, when products are standardized, users often benefit from lower prices and lower searching costs (costs entailed in locating and comparing products). However, users will often disagree about the best standard. Having invested heavily in one technology, for example, they may oppose a standard that would require switching to another.

Given these competing interests, and the tremendous potential for gains and losses, it is clear why setting standards has often been a contentious process requiring considerable negotiation and bargaining. As Besen and Saloner have described it:

... standard-setting has moved from the technical concern of a single firm to a factor with important implications for competition. As a result, the processes by which standards are set have come to be subject to detailed scrutiny by both the regulatory authorities and the courts. In a sense, telecommuni-

<sup>15</sup>To encourage standardization in Europe, for example, the European Commission, in February 1988, mandated that governments of all member nations invest in computer equipment conforming to the standards of the International Standards Organization (ISO).

<sup>16</sup>John Williamson, "CEPT Agrees To Speed ISDN," *Telephony*, Apr. 17, 1989, p. 15.

<sup>17</sup>Steve Titch, Margie Semilof, and John Berrigan, "Missing Links," *CommunicationsWeek, CLOSEUP*, Sept. 12, 1988, p. C-7.

<sup>18</sup>See, for a discussion, Ian M. Lifchus, "Standards: Technical Umbrellas for the Information Age," *Telephony*, Apr. 25, 1988; see also, Alan Stewart, "A Users Guide to ISDN Standards," *Telecommunications*, May 1988, pp. 34, 35, 36, and 37.

<sup>19</sup>Berg, *op. cit.*, footnote 1, p. 9.

<sup>20</sup>Larry DeBoever, "Trek Toward Connection," *Computerworld*, Nov. 16, 1987, pp. S1-S13.

Figure 11-1—ISDN Subscriber Loop Interface

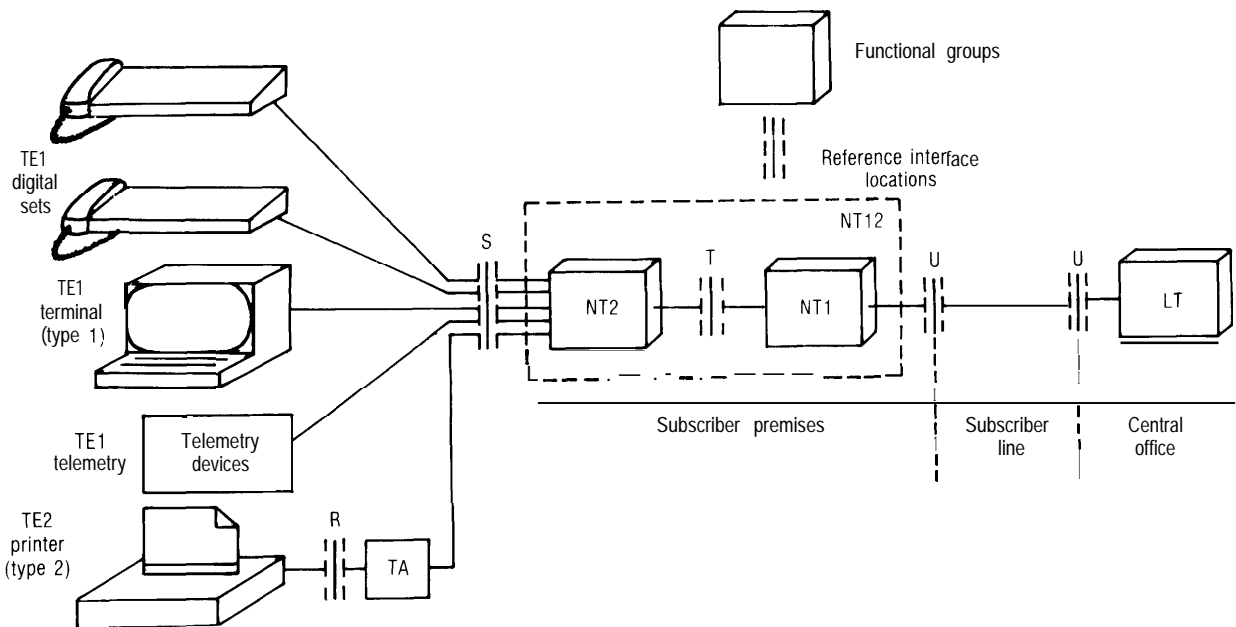

U Interface—Two-wire transmission carrying the 2B + D channel format Implemented by the MT8972 DNIC  
 T Interface—Four-wire Interfaces intended to be physically identical for Star or Passive bus configurations  
 S Interface—Four-wire Interfaces intended to be physically identical for Star or Passive bus configurations

R Interface—Existing standard interface such as RS-232-C or X 21.

Network Termination 1—Transmission line terminating equipment at subscriber side of network

NT2—Network Termination 2— Intelligent device to convert the single T interface to multiple S interfaces.

Terminal adaptor—Conversion between the ISDN interface (S) and existing interfaces (R) such as RS-232-C or X 21

Terminal equipment (type 1)—intelligent digital devices that can interface directly to the ISDN specified S or R interfaces.

Terminal equipment (type 2)—Existing terminal equipment used with existing Interface standards such as RS-232-C or X 21

SOURCE: Reprinted with permission from Telephony, June 17, 1985, p. 31.

cations standards have become too important to leave their determination to the telephone companies.<sup>21</sup>

The involvement of so many players with conflicting perspectives is likely to make standards-setting processes more visible, more intractable, and, hence, more politicized in the future. Increasingly, issues are emerging not only with respect to what standards should be adopted, but also with respect to how, and by whom, decisions about standards should be made. Recently, for example,

there has been a sizable increase in the number and variety of groups getting involved in standards-making issues. Many user groups are now seeking a much more active role, in some instances even bringing their cases directly to international standards-setting groups.<sup>22</sup> The desire for an increased role is not surprising, given that users' network requirements are now so much more sophisticated and mission-critical to their business operations.<sup>23</sup> Vendors and suppliers are also taking note of this

<sup>21</sup>Besen and Saloner, op. cit., footnote 1, p. 1.

<sup>22</sup>For a discussion, see, for example, Suzanne Wiseman, "ICA Seeks Strong User Role in Standards," *CommunicationsWeek*, June 27, 1988; see also discussion of the role of users in developing the Manufacturing Automation Protocol (MAP) and Technical and Office Protocol (TOP) standards, Stan Kolodziej, "No More Money to Burn: Industry Demands Solutions, MAP Begins to Deliver," *Computerworld*, Dec. 7, 1988, pp.31 -34. It should be noted, moreover, that users can also be vendors, a fact that can cloud motivations.

<sup>23</sup>Dale Kutnick, "OSI a High-Stakes Game to Play," *Computerworld*, Sept. 12, 1988, p. 19.

new situation, and are sending more of their top-notch people to handle standards issues.<sup>24</sup>

**Factor 5: Increased technological complexity and the shift from product-implementation standards to anticipatory-process standards.**

The rapid pace of technological change, combined with the convergence of communication and information technologies, has made standards-setting much more complicated. In the past, standards were generally established in response to pre-existing products in order to facilitate their implementation.<sup>25</sup> Today, however, this is no longer typically the case. Standards are now much more future oriented, and the process of setting a standard often anticipates the actual creation of a product. The need for these new kinds of standards, known as anticipatory-process standards,<sup>26</sup> reflects the fact that, today, there is a much greater need for interoperability in the area of information technology, given an environment where the technology is rapidly changing, there are many vendors, and there is a growing value attached to the exchange of information.<sup>27</sup> One example of an anticipatory-process standard is the OSI reference model. It describes how open systems should operate from a generic perspective, as well as the full range of implementation choices that are compatible within this framework.

The shift from product-implementation standards to anticipatory-process standards will create new

kinds of problems, and there is little historical, or analytic, guidance for addressing them. For example, the traditional, academic economic literature on standards, which focuses heavily on the development of domestic product standards and the economic factors that drive them, is becoming less and less relevant to, and less able to account for, the process of setting international, anticipatory-process standards, such as those for ISDN and OSI. As Cargill has noted, the outcomes of such processes do not depend on economic variables alone, but on a number of variables, which can range from national goals to personalities and preferences of individual participants. As he has described the intricacies and complexities involved in standards-setting:

imagine a typical international standards meeting working on a conceptual/process standard for the information technology industry. Assume a small meeting of approximately thirty representatives—say twelve from providers, eight from government, five from impacted users or quasi-governmental bodies, several consultants, and a couple of academics. Then consider the national, regional, and international aspects of the meeting, the needs of the providers to ensure that their processes are not compromised, the governmental issues such as security and national prestige and protection of industry, and the academic sections insistence on a good and technologically sound solution. Finally, factor in the personal characteristics of the delegates, most of whom are highly competent engineers who have been working on this type of technological

<sup>24</sup>Stan Kolodziej, "Egos, Infighting and Politics: Standards Progress Bogged Down..." *Computerworld, Focus*, Sept. 7, 1988, p. 17. As Cargill has noted, "... industry-both users and providers alike-is more and more aware that standards are a serious business concern that can cripple or aid efforts to minimize exposure to the vagaries of the market. As this realization has grown, the composition of the standards groups has begun to change. Instead of coming from a regulatory or internal standards background, more and more representatives have a background in technical management. Perfect standards are no longer the goal; instead, the focus is on obtaining a workable and acceptable standard within a time frame that will allow it to be useful." Cargill, op. cit., footnote 1.

<sup>25</sup>As Cargill has defined this kind of standard: "A product standard describes a product or service being standardized. The product, which should have a future orientation (although this is not an absolute necessity), defines the standard in that the standard merely exists to serve as a paradigm for the product within the industry. In other words, the standard and the product/service being described are equivalent within the confines of a single discipline/structure, free of external dependencies. The standard assumes that the external interfaces to the product it described are relatively constant and consistent. Although the standard can accept a wide variability of input if the standard specifies the variability, it is more usual for the product standard to be constructed rather tightly. If a standard calls for a series of options, which can be randomly implemented, in terms of numbers, sequences, and fashions, then its purpose is defeated." Ibid.

<sup>26</sup>Again, as defined by Cargill, "The process standard focuses on the transmutation of a customer need into a customer solution, examining those things that are input and output to a system, but not concerning itself especially with the products that accomplish that transmutation. In other words, it is concerned with the ends, not means. . . This concept has substantial implications for the development of standards because it is device independent—rather than specifying a certain product or service to accomplish a need, it merely describes the need, the constraints to achieving the solution, and the output necessary to allow the results of the standardized solution to interplay with solutions from other process standards." Ibid. For a discussion of anticipatory standards see also, Martin B. H. Weiss, "Compatibility Standards and Product Development Strategy: A Retrospective of Data Modern Developments," Carnegie-Mellon University, March 1988.

<sup>27</sup> Cargill, op. cit., footnote 1.

problem for years and for whom this arena is a chance to air their theories to their peers.<sup>28</sup>

**Factor 6: The growing divergence of vendor/user goals and interests.**

*The* move from product-implementation to anticipatory-process standards has also made it more difficult to reconcile the needs of vendors and users.<sup>29</sup> In the past, the needs of users and Providers generally coalesced, once they had agreed among themselves that a standard was required. The vendor sought to design his product to the standard that best met the user's need. Today, however, providers' and users' needs are much more divergent. Trying to leave their options open in a rapidly changing technological environment, while at the same time providing for some kind of predictability, providers favor the creation of generic standards that, by laying out all technical possibilities, allow them to build to the future capabilities of their systems. Users, on the other hand, have no interest in a broad range of technical possibilities; they want very specific standards that can be designed to meet their particular business needs. They find the process of developing such complex genetic standards much too slow for their purposes. From the users' point of view, participation in this process can be quite expensive since, unlike vendors and suppliers, they are primarily engaged in other economic activities.<sup>30</sup>

Reflecting this growing gap between vendors\* and users' perceptions of standards and the standards-setting process, some users established special consortia to speed up the process. In addition to developing specialized standards protocols based on the OSI model, these groups also sought to use their organizational influence and buying power to encourage vendors to implement products designed for their needs.<sup>31</sup> At the initiative of General Motors, for example, users developed the Manufacturing Automation Protocol (MAP), which is considered to be an essential building block for computer-integrated manufacturing. In addition, the Technical and Office Protocol (TOP) was developed under the auspices of

Boeing, while the Government Open Systems Interconnection Profile (GOSIP), a protocol designed to meet the information-processing needs of government agencies, was developed under the auspices of the National Institute for Standards and Technology (NIST). Most recently, a number of electric utility companies, working through the Electric Power Research Institute, have agreed to develop a set of OSI-based communication protocols that will allow them to interconnect their dissimilar systems and networks.<sup>32</sup> Libraries, bankers, and the weather-forecasting industries are also considering the development of special protocols.

**Factor 7: The increasing demands on international standards-setting organizations.**

*The* growing complexity of standards issues also puts additional burdens on standards-setting institutions. This is reflected in the extended period of time required for standards to be formally ratified, and the rapid multiplication of standards-setting committees and subcommittees. As one journalist observing international standards meetings has described these sessions:

The content [of the materials discussed] is technical, voluminous, and difficult. . . . the minutes look like telephone books. . . . Readings come to several hundred pages of technical matter each month.<sup>33</sup>

Under these circumstances, it is estimated that the volume of the CCITT "colored books," which comprise all standards recommendations, is doubling approximately every 4 years.<sup>34</sup> It can take between 4 to 8 years for an international standard to be written. Even after standards have been set in a formalized, international, consensus-based process, users still have to specify the particular uses to which these standards will be applied, and vendors have to implement compatible technologies that meet these standards and specifications. Given the increased demands on standards-setting institutions, some people fear that the process may become so bogged down that many standards will actually become

<sup>28</sup>Ibid.

<sup>29</sup>For a discussion, see *ibid.*

<sup>30</sup>Ibid.

<sup>31</sup>See for a discussion, Kolodziej, *op. cit.* footnote 22, pp. 31-33.

<sup>32</sup>Kelly Jackson, "Utilities t. Link Nets Via OSI," *CommunicationsWeek*, Mar. 27/1989, p.1.

<sup>33</sup>Timothy Haight, "Standards-Setting and the Limits of Journalism," *CommunicationsWeek*, Mar. 14, 1988, p.14.

<sup>34</sup>Denis Gilhooly, "Expanding Scope for CCITT," *CommunicationsWeek*, Jan. 16, 1989

obsolete before they are officially ratified.<sup>35</sup> There is also concern that new standards groups might emerge that would challenge the central role of the existing organizations, creating even greater coordination problems. With these concerns in mind, many have urged that the existing standards-setting institutions be revamped and reformed.<sup>36</sup>

## STRATEGIES AND OPTIONS

Interoperability in communication systems can be accomplished in two ways—through a process of standardization, whereby the components of a system are designed to conform to one another; or through the use of translator devices, or “black boxes,” designed to connect incompatible parts. Standardization processes themselves are also varied. For example, standards can be established de facto in the marketplace; they can be agreed to on a voluntary basis, by consensus, worked out through negotiation; or they can be mandated by government. In many cases, the process does not end with the setting of standards; before interoperability can be achieved, standards must be further specified and ultimately implemented.<sup>37</sup>

Given these different phases and the multiple routes for achieving interoperability, Congress might select from a broad range of strategies designed to enhance the interoperability of the U.S. communication system. These strategies include:

- supporting research to provide better data and a more analytic rationale for standards-setting decisions;
- allowing for the emergence of market solutions, either in the form of gateway technologies or through the de facto setting of standards;
- indirectly influencing the standards-setting

process by providing assistance and guidance to foster the setting of standards;

- influencing the setting of particular standards by providing incentives or imposing sanctions; and
- mandating industry-wide standards.

Research on standards, as well as past experience, clearly illustrate that there is no single optimum way of arriving at interoperability.<sup>38</sup> The level of interoperability to be strived for, and how it should be achieved, will vary in each case, depending on the state of the technology’s development, market demand and preferences, the structure of the industry, and the social, political, and economic stakes involved.<sup>39</sup> Thus, although some generalizations can be made about the overall circumstances under which particular government strategies and options are likely to be the most appropriate, these generalizations will need to be tailored to the specifics of each case. For this reason, the discussion below is divided into two parts. The first examines strategies and options for arriving at interoperability from a general perspective (see figure 11-2), and the second looks at three specific cases where interoperability, or the lack of it, has generated significant policy issues. These three cases include a discussion of the standards issues relating to: 1) the establishment of ISDN, 2) the evolution of OSI, and 3) the creation of ONA.

### *General Discussion of Strategies*

#### **Strategy 1: Support research to provide better data and a more analytic rationale for standards-setting decisions.**

As discussed in chapters 3 and 4, setting standards often entails trade-offs between efficiency and ease

<sup>35</sup>See, for one discussion, James G. Herman, “Is ISDN Obsolete?” *Network World*, Aug. 10, 1987. As Herman points out, “The ISDN standards committees are caught in a squeeze between falling requirements for voice and rapidly rising requirements for data. The long-awaited standards may be too little, too late for data and yet be wastefully oversized for voice. It will be interesting to see whether they gain acceptance and fulfill their promise or wither and die from premature obsolescence.”

<sup>36</sup>For a discussion see, “Irmer Calls for Reform of CCITT,” *Telecommunications*, October 1988, p. 11; and Denis Gilhooly, “CCITT Adopts Plan to Speed Standards Approval Process,” *CommunicationsWeek*, Dec. 19, 1988, p. 24.

<sup>37</sup>&1 Cargill has described a six-phase process of standardization: 1) the pre-conceptualization stage, 2) the formal process, 3) conceptualization, 4) discussion, 5) writing the standards, and 6) implementing the standard. As he notes: “If the proposal for a standard makes it over the first hurdle, and enters the formal process, it must go through three phases of the formal process. If it successfully completes all of these steps, it has the potential for being a viable standard—one that is accepted by the IT [information technology] community, and which will and can be used. The final hurdle is the implementation stage. Failure to complete any of these stages will not disqualify it from being a standard—it may only disqualify it from being a standard that is both used and useful.” Carl F. Cargill, “A Modest Proposal for Business Based Standards,” unpublished paper, p. 6.

<sup>38</sup>Besen and Saloner, op. cit., footnote 1, p. 2.

<sup>39</sup>See, for example, Besen and Johnson, op. cit., footnote 1; Besen and Saloner, op. cit., footnote 1; and Berg, Op. cit., footnote 1.

**Figure 11-2—Congressional Strategies and Options to Address Interoperability/Coordination of the Communication Infrastructure**

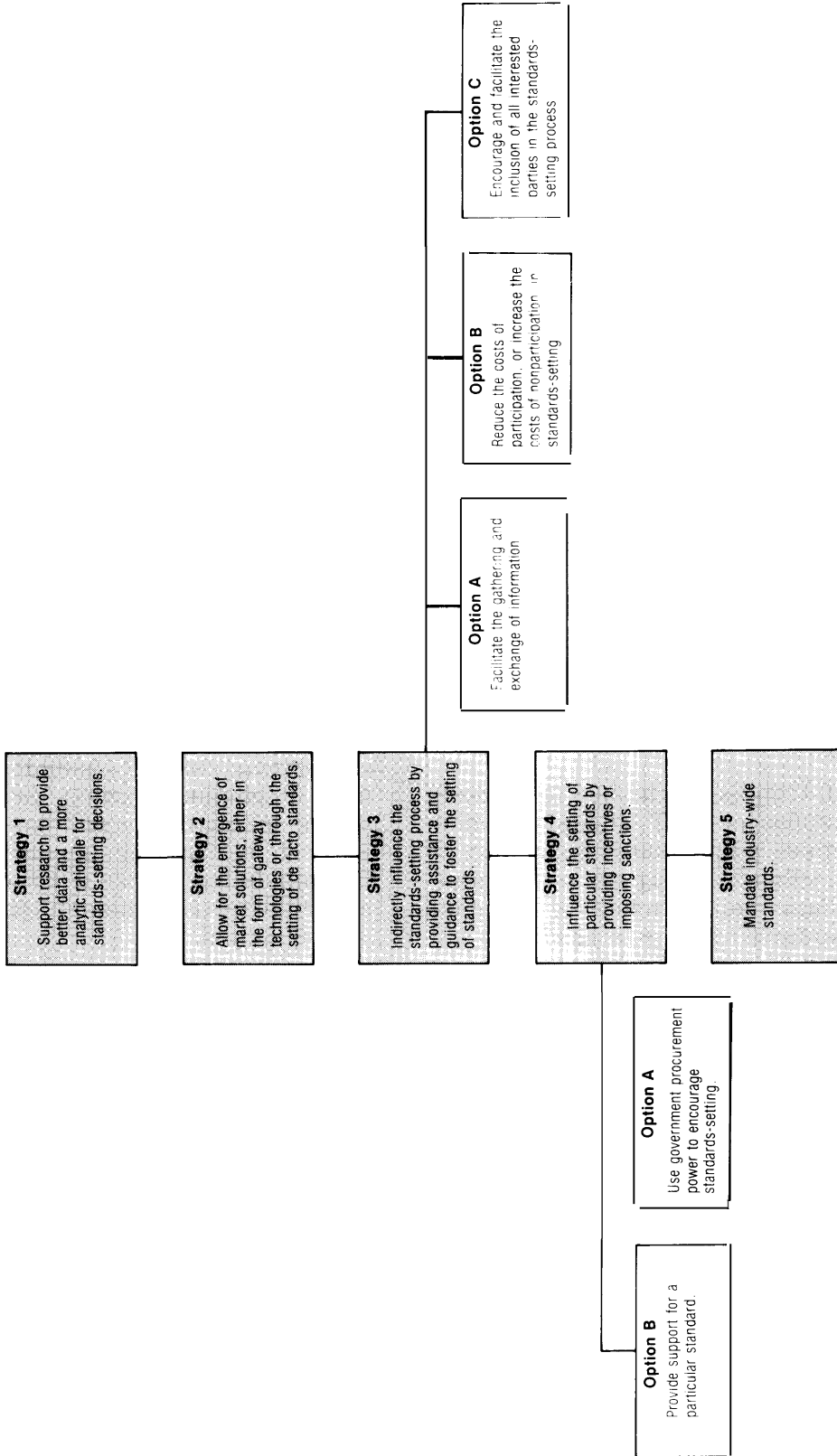



of access on the one hand, and innovation and technological change on the other. Understanding these trade-offs requires not only an understanding of the many policy issues that standards raise, but also considerable technical expertise. For policymakers, keeping pace with technological change is becoming increasingly more difficult. As one critical observer of the present situation has described it:

Many of our institutions—both public and private—do not seem to have evolved along with the technology. Our present public institutions consist of the FCC [Federal Communications Commission], largely operating with a diminished capacity, and pieces of a few other federal agencies, mixed with 50 state commissioners, each with the notion of what the telecommunication network should be. . . . Far more ominous, however, is NARUC's [National Association of Regulatory Utility Commissioners'] decree that on matters of ONA, each state will feel free to go its own way.<sup>40</sup>

One action that Congress might take, therefore, is to further enhance the economic and technical knowledge within government agencies about the new communication and information technologies, and how they may change the Nation's communication infrastructure.

To this end, Congress might fund the National Science Foundation or NIST to conduct further research on the policy and economic implications of standards and standards-setting processes in communication. Such research would be opportune because the academic literature on standards is just beginning to come to grips with the changes wrought by the divestiture of AT&T and the convergence of communication and information technologies.

However, it will be important to ensure that this work is shared among all agencies involved with standards. At present, there appears to be little, if any, formal effort to share such research and experience. In part, this lack of coordination stems from the fact that, in the United States, most standards' activities have taken place in nongovernmental fora, such as Accredited Standards Committees of the American National Standards Institute (ANSI). Ironically, it is said to be in these private

sector meetings that many people from different government agencies get together.

However, if too formal a coordination process were established, the sharing of information might provoke some jurisdictional disagreements among agencies. As noted in the discussion of jurisdictional issues (see ch. 13), efforts at coordination are rarely, if ever, neutral with respect to the distribution of power and authority. And those who are bound to lose in the process of coordination are likely to resist any change.

**Strategy 2: Allow for the emergence of market solutions, either in the form of gateway technologies or through the setting of de facto standards.**

Both research on standards and past experience make it clear that, because of the costs and trade-offs involved, government efforts to bring about interoperability by establishing standards have not always worked in the public interest. On the contrary, when standards have been prematurely set—as in the case of color television—they have often hindered the development of a better technology.<sup>41</sup> Because of these experiences, many recommend that the government intervene in the standards-setting process as little as possible, allowing the marketplace to provide solutions to the problems of interoperability. Such solutions may take the form of either de facto standards or gateway technologies that serve as translators between otherwise incompatible equipment or systems.

Generally speaking, this minimalist approach is the one preferred by many vendors and suppliers, especially those in the information industry. Because the choice of standards can have a major impact on competition, many of them are deeply suspicious of, if not opposed to, the government playing an active role in the standards-setting process. This point of view has been aptly stated by Carl Cargill, senior standards consultant at Digital Equipment Corp. Defending the present system of voluntary, consensus standards against the criticism that it is too slow and inefficient, he contends, for example, that:

<sup>40</sup>Anthony M. Rutkowski, "Toward a National Information Fabric: organizing fOr Success," *Telecommunications*, September 1987, p. 8.

<sup>41</sup>Nathan Rosenberg, "Reflections on the Future of the Telecommunications Industry," OTA contractor report, December 1986, p.10.

... a specialist who does not work for a company that either makes or uses the product will very likely lose sight of why standards exist. . . . the bureaucracies that currently control much of the standardization process in Europe . . . have spawned disasters. Standards planning in the U.S. is where it should be right now—in the hands of the people most directly impacted. This combination of providers and users creates an understanding of what is needed far better than any expert consultant planning agency.<sup>42</sup>

This minimalist approach is reflected in the FCC's policy strategy for standards over the past several years. The FCC's rationale is exemplified, for example, by its decision on cellular radio, in which it stated:

We believe it would be inappropriate at this time to embark on a proceeding to select technical standards for future cellular systems. Such a course would be premature given the early stage of development of new cellular and is likely to discourage technical innovation. Instead we seek to foster the development of competing technologies that could then be evaluated in the market.<sup>43</sup>

Economic research and analysis on standards and past experience suggest that this market approach is most likely to result in standardization when all interested parties: 1) prefer the same standard, 2) have something positive to gain from standardization, and 3) have adequate information about the intent of other parties. This optimal situation occurs only rarely.<sup>44</sup> However, even when all of these conditions do not hold true, economists argue that government intervention in the standardization process is likely to have more negative than positive consequences—measured in terms of the criterion of economic efficiency—when: 1) no single technology stands out as being preferable, 2) technologies are undergoing rapid change, and 3) a technology has a variety of different uses. They contend that, under these circumstances, it is often best to allow users to work out their own compatibility problems, either by negotiating among themselves or with the

help of companies that will provide them with gateway and integration services.<sup>45</sup>

Standards decisions, however, also need to be weighed against noneconomic criteria. There are times when having “a” standard (even if it is not the optimal one from an economic criterion of efficiency) might be better than having no standard at all. Standards might be required, for example, in order to effectively use defense technologies. It was, in fact, for this reason that the National Research Council (NRC) urged the adoption of UNIX as a standard operating system in its evaluation of the Nationwide Emergency Telecommunications Network.<sup>46</sup> Or, as in the case of HDTV, standards might be sought in order to promote U.S. access to the international market.<sup>47</sup> The government could also press for standards as a way of encouraging the development of what it considers to be an essential, but inchoate, market. It might be argued, for example, that one way of fostering information services for residential and small-business users would be to encourage the development of teletext and videotex standards. Finally, government might become involved in standards-setting processes as a way of structuring competitive markets, as it may be further required to do in the case of implementing the ONA process.

### **Strategy 3: Indirectly influence the standards-setting process by providing assistance and guidance to foster the setting of standards.**

*Option A: Facilitate the gathering and exchange of information.*

At times, the failure of an industry to set standards is due not to disagreements among parties about the need for standards, or even about the preferred technology that should be adopted, but rather to the fact that the parties involved are unaware of the preferences and intentions of others. As Besen and Saloner have pointed out, vendors might hesitate to take the first step towards the standardization of a

<sup>42</sup>Carl Cargill, “ANSI Me This: Who Has Control Over Standards?” *Computerworld*, July 4, 1988, p. 17.

<sup>43</sup>As quoted in Dr. George Calhoun, “The Next Generation of Cellular Radio,” *Telecommunications*, June 1988, pp. 41-45.

<sup>44</sup>See footnote 1. This is not to say, however, that the optimum standard will be set in the marketplace. For, as Besen and Johnson have pointed out, there are some types of market situations in which the wrong technology (based, that is, on the criterion of economic efficiency) might be selected as a standard. Besen and Johnson, op. cit., footnote 1.

<sup>45</sup>See footnote 1.

<sup>46</sup>Martin Edmonds, “Defense Interests and United States Policy for Telecommunications,” OTA contractor report, June 1988.

<sup>47</sup>See Norm Alster, “TV’s High-Stakes, High-Tech Battle,” *Fortune*, Oct. 24, 1988, pp. 161-170.

product if they are unsure whether other vendors will follow or if they have no way to bargain and negotiate for the exchange of side payments.<sup>48</sup> In cases where the lack of information exchange seems to be the direct cause of the lack of standards, the government may want to intervene to foster an exchange among interested parties.

One way to do this would be through FCC fact-finding proceedings. For example, acting either on its own or in response to industry petitions, the FCC might initiate an inquiry, or Notice to a Proposed Rule Making, to ascertain the views of the public about the need for, or feasibility of, a particular standard. This approach works best when interested parties basically agree on what constitutes the best standard. Where there are strong disagreements, however, this method might actually exacerbate differences, and hence serve to hinder the development of standards.<sup>49</sup> Another problem with this approach is that it does not call for parties to get together to work out their differences. Moreover, because industry comments are presented independently of one another, the data that it generates may not be comparable, making it difficult for the FCC to interpret them.<sup>50</sup>

Alternatively, the FCC might encourage the establishment of an interindustry committee to look into a standards problem and report its findings. This was done in the case of HDTV with the establishment of the Advanced Television Services (ATS) Advisory Committee. Comprised of top executives of television and related industries, this committee was established by the FCC in July 1987 to advise the agency on standards and spectrum allocation. Broadcasters, themselves, set up the Advanced Television Test Center (ATTC) to advise the FCC's ATS Advisory Committee. One advantage of this kind of initiative is that it allows interested parties to

work out their differences first and then present the FCC with more uniform information.<sup>51</sup>

*Option B: Reduce the costs of participation, or increase the costs of nonparticipation, in standards-setting.*

Attempts to set standards might also fail because the effort required to participate in the standards-setting process appears greater to the relevant parties than the perceived benefits. The classic case is that of trying to set up a system of weights and measures; because all parties benefit in the same way from the existence of standards, the costs of trying to develop them may be greater than the perceived benefits.<sup>52</sup> But such a situation might also arise, for example, if the market for a product is small and perhaps undeveloped.<sup>53</sup> When there is no present or perceived future market for a product, industry may have little incentive to spend the time, money, and effort required to develop standards for it. And, in the event that standards are required for a market to develop, the situation might result in a state of inertia, engendering neither standards nor a market. Some say, for example, that this situation accounts for the failures of AM stereo, teletext, and videotex.<sup>54</sup> It may also explain why vendors have been hesitant to implement ISDN standards.

In such cases, the government might try to overcome the inertia by initiating proceedings as described above. As always, the government would have to weigh the cost and potential risks of action against the benefits to be gained by such efforts. It should be noted, however, that the risk of the government forcing a standard prematurely is less when there is inertia and there are no strong advocates of a particular standard.<sup>55</sup>

*Option C: Encourage and facilitate the inclusion of all interested parties.*

<sup>48</sup>See footnote 1. Side payments refer to bargains struck between companies to further the standards-setting process.

<sup>49</sup>Ibid.

<sup>50</sup>Besen and Johnson, for example, suggest that this lack of comparable data accounts in part for the FCC's hesitancy to set standards for stereo TV. Op. cit., footnote 1, p. 54.

<sup>51</sup>It should be noted that although the cable industry was represented on the ATS Advisory Committee, the National Cable Television Association declined an invitation to participate in the ATTC.

<sup>52</sup>As Besen and Saloner note, "paradoxically, when standardization cannot create a competitive advantage, so that achieving a consensus should be easy, the incentive to free ride is greatest." Op. cit., footnote 1, p. 6.

<sup>53</sup>Besen and Johnson, op. cit., footnote 1, p. 54.

<sup>54</sup>Ibid.

<sup>55</sup>Ibid.

With the growing importance of communication and information-based services, more people have a stake in the outcome of decisions about interoperability in the communication infrastructure. One role that the government might play, therefore, is to assure that all interested parties are included in the debates about standards. The government has already taken some steps in this direction. For example, one reason NIST organized the North American ISDN User's Forum was to assure users a voice in ISDN implementation.<sup>56</sup> Users were also incorporated into the ONA proceedings, as required by FCC rules. Not every group has such leverage, however. Thus, government may have to take further steps to assure that a wide assortment of views are incorporated into the standards process. Small businesses, in particular, have expressed concern that they not be left out. Moreover, as described below, there is clearly a need for greater coordination among State, Federal, and international jurisdictions in working out standards problems.

**Strategy 4: Influence the setting of particular standards by providing incentives or imposing sanctions.**

In a number of cases, a firm (or firms) may have a strong proprietary interest in particular technologies, and therefore be unwilling to cooperate in establishing an industry standard. Instead, they will try to have their own technology established as a de facto standard in the marketplace. Until recently, for example, this was IBM's style of dealing with standards. Similarly, when users already have an installed base of technology that is built around one particular set of standards they will probably be opposed to switching to anew set. If the government were to promote standardization under such circumstances, it would most likely have to provide sufficient incentives and/or sanctions to induce the parties-at-interest to compromise.

*Option A: Use government procurement power to encourage standards-setting.*

Because the Federal Government is one of the largest purchasers of both communication and infor-

mation technologies, it has considerable leverage in these markets. Thus, one way in which the government can encourage standardization is by using its procurement power. By doing so, the Federal Government was able to press IBM to support the computer language, COBOL. More recently, the Department of Defense, responding to NRC recommendations calling for greater standardization of operating protocols, has required that the existing Transport Control Protocol/Internet Protocol (TCP/IP) be replaced by the International Standards Organization's OSI protocol, within 2 years. It should be noted, however, that many equipment vendors disapproved of this decision and formed a lobbying group, the Coalition for Working Systems, to resist the proposal.<sup>57</sup>

*Option B: Provide support for a particular standard.*

Without mandating a particular standard, the government might make its preferences clear, focusing on one kind of standard over others. Such an approach might be used to restrict or delay the adoption of a particular standard, if the technology is considered to be immature. For example, the FCC used this approach when considering standards for stereo television. The industry was eager for government to establish a standard, which is not surprising given the interdependence of, and hence the need for compatibility between, transmission and receiver systems. However, instead of adopting the standard put forward by an industry committee, the FCC decided to forgo mandatory standards and allow other technologies to evolve. But it did support the industry's choice by protecting their system from interference by others.<sup>58</sup> Given the agreement among stakeholders, this limited support was sufficient for a standard to evolve; when no competing system emerged, the system, with the government's support, became the de facto standard.<sup>59</sup>

**Strategy 5: Mandate industry-wide standards.**

In recent years, the government has tried, whenever possible, to avoid taking direct control over the standards-setting process and mandating industry-

<sup>56</sup>NIST, "North American ISDN User's Forum," undated.

<sup>57</sup>Edmonds, op. cit., footnote 46, p. 44.

<sup>58</sup>Besen and Johnson, op. cit., footnote 1, p. 65.

<sup>59</sup>Ibid.

wide standards. This approach is designed to foster the development of new technologies, and it appears to be appropriate in the light of rapidly changing technologies. However, it may be less workable in the future, given the globalization of the communication system and the economy. As other countries establish standards in such key areas as ISDN, OSI, and HDTV, the U.S. Government may, at the very least, have to foster the domestic processes for deciding on standards. If the rest of the world moves forward on standards without the United States, waiting for the domestic market to set de facto standards may be costly in terms of U.S. participation in world trade. Thus, in a few instances, the government may have to play a more active role, even mandating an industry standard in some circumstances. Such a decision, however, would face strong opposition from a number of industry stakeholders, especially those who benefit from existing proprietary technologies.<sup>60</sup>

### Strategies *and Options in Three Cases*

#### Integrated Services Digital Network

The term “integrated services digital network” (ISDN) is a confusing one, referring to both a particular kind of communication network<sup>61</sup> and the set of standards that support it.<sup>62</sup> Understanding the term is further complicated by the fact that it has been used to refer to both narrowband ISDN (N-ISDN)<sup>63</sup> as well as to broadband (B-ISDN),<sup>64</sup> Although this section focuses specifically on the setting of ISDN standards, consideration of the value of ISDN communication networks—narrowband

and/or broadband—will serve as an important criterion for determining the appropriateness of any government role in the development of these standards.

As discussed earlier, standards are generally accepted criteria that serve as a basis of comparison. In telecommunication, standardized interfaces consist of specified sets of values, or rules, to which devices and systems must conform if they are to work correctly and consistently. ISDN interfaces serve “to handle electrical signals that contain information and conform to certain values of size, shape, repetition rate, pulse sequence, and noise environment.”<sup>65</sup> They are designed to transport voice, data, video, or some combination of these. To do so, ISDN standards need to be established for the: 1) transport mechanisms (transmission), 2) supervisory control signaling (protocols), 3) procedures for interconnecting terminals (connectivity), and 4) the type of intelligence to be passed (services).<sup>66</sup>

ISDN standards have been characterized as “anticipatory” standards—that is, standards that are produced prior to a product’s introduction. One purpose of establishing standards in this fashion is to facilitate the evolutionary or orderly development of a technology by allowing for backwards compatibility. Another purpose is to foster multiple development efforts by providing a cohesive structure into which future products can be integrated.<sup>67</sup> In the specific case of ISDN, standards are being developed to support the evolutionary transformation of a voice-based telecommunication network into a gen-

<sup>60</sup>Reviewing the OTA draft report, some industry stakeholders (for example, AT&T and the American Petroleum Institute) questioned the OTA proposition that government involvement in the standard-setting process can make a significant, and positive, difference under some circumstances. From their perspective, the arguments in favor of this option are unsubstantiated.

<sup>61</sup>As described by the CCITT Study Group XVIII, which is responsible for coordinating ISDN standards, ISDN is “a network evolved from the telephony ISDN that provides end-to-end connectivity to support a wide variety of services, to which users have access by a limited set of standards of multipurpose customer interfaces. For a discussion, see Rolf Wigand, “Integrated Services Digital Networks: Concepts, Policies, and Emerging Issues,” *Journal of Communication*, Winter 1988, pp. 29-49.

<sup>62</sup>For a discussion of the confusion caused by this term, see Tom Valovic, “Fourteen Things You Should Know About ISDN,” *Telecommunications*, December 1987, pp. 37-42.

<sup>63</sup>The two standard user interfaces for N-ISDN were adopted in 1988 at the Melbourne meeting of the CCITT, after 4 years of discussion. They are the Basic Rate Interface (BRI) and Primary Rate Interface (PRI). The BRI is composed of two channels (each of which transmits at 64 kilobits simultaneously) and a D channel that transmits at 16 kilobits and carries information for signaling and for controlling the B channel. In the United States, the PRI consists of 23 channels (each of which transmits at 64 kilobits) and a D channel that signals at 64 kilobits.

<sup>64</sup>Considerable confusion and disagreement still exist with respect to the actual form that broadband ISDN will take. The term usually refers to very high capacity transmission channels, generally in excess of 100 megabits per second (Mbps).

<sup>65</sup>Alan Stewart, “A User’s Guide to ISDN Standards,” *Telecommunication.s*, May 1988, pp. 85-90.

<sup>66</sup>*Ibid.*, p. 86.

<sup>67</sup>Hack, *op. cit.*, footnote 1, P. 5.

eral-purpose network, equipped to carry all kinds of electronically transmitted, digital information.<sup>68</sup>

The original impetus for ISDN standardization came from Europe, where the postal, telegraph, and telephone authorities (PTT's) saw it as a means of both upgrading the public network and discouraging the development of private networks, which they feared would be outside of their control.<sup>69</sup> Moreover, by providing interoperability for data communication, ISDN would also make it easier for the European communication industry to compete with IBM, which, through the development of system network architecture (SNA), was preparing to provide interoperable data transport among computers on a proprietary basis.<sup>70</sup> The importance attached to this strategy is clearly revealed in the Nora-Mine Report, which advised the French Government:

Controlling the network system is thus an essential objective. This requires that its framework be designed to serve the public. But it is also necessary for the state to define access standards; otherwise the manufacturers will, utilizing the available routes but subjecting them to their own protocols . . .

The level of standardization will thus shift the boundary between the manufacturers and the telecommunications organizations; it will be a bitter struggle, since it will develop out of a reciprocal play for influence. But the objective of public control indicates the strategy to follow: increase the pressure in favor of standardization.<sup>71</sup>

Today, European ISDN standards are being developed by the Conference of European Postal Tele-

communications Administrations (CEPT),<sup>72</sup> as well as by the European Computer Manufacturing Association's (ECMA) Technical Committee 32 Technical Group 1, and the recently established European Telecommunications Standards Institute. Although there has always been a general European consensus in favor of ISDN, some significant differences persist among country approaches.<sup>73</sup> Concerned that incompatible standards might retard the development of a pan-European telecommunication market, the European Council of Ministers, in November 1987, called for immediate joint action to develop precise interfaces, a common timetable, and a user community large enough to establish new services.<sup>74</sup> In addition, between 1987 and 1991, the European Commission plans to spend about \$9 million to monitor the telecommunication administrations' ISDN developments and to finance promotional activities in support of ISDN.<sup>75</sup> Notwithstanding all of these joint activities, progress on ISDN to date has been disappointing to the European Commission. As a result, it has had to slow down its push towards developing B-ISDN.<sup>76</sup>

Given the competitive motivations behind much of the European interest in ISDN, it is understandable that the original U.S. response to it was less than enthusiastic.<sup>77</sup> This skeptical attitude was reinforced by the fact that ISDN, built around a uniform set of standards, was seen by many as having an inherent bias in favor of the centralized provision of telecom-

<sup>68</sup>William Lehr, "ISDN: An Economist's Primer for a New Telecommunications Technology," Stanford University, Technology and Progress Seminar, Feb. 14, 1989, p. 8.

<sup>69</sup>James G. Herman and Mary A. Johnston, "ISDN When? What Your Firm Can Do in the Interim," *Data Communications*, October 1987, p. 226.

<sup>70</sup>For a discussion, see Noam, "The political Economy of ISDN," op. cit., footnote 2, Pp. 28-35.

<sup>71</sup>S. Nora and A. Mine, *The Computerization of Society, Report to the President of the French Republic* (Cambridge, MA: MIT press, 1980), pp. 74-75, as cited in Noam, *ibid.*

<sup>72</sup>For a discussion, see Doug Barry, "EuroPan Standards Gather Pace," *Telecommunications*, January 1989, pp. 64-70. Although the PTTs are pressing forward with their plans for ISDN, some public opposition has emerged over time. In Germany, for example, the Green Party has questioned the value of moving rapidly towards the deployment of information technology, while unions, churches, and other groups have raised questions about the impact of ISDN on jobs. Wigand, op. cit., footnote 61, p. 37.

<sup>73</sup>One area of difference, for example, is in proposed user interfaces. France plans to implement "telephone user part plus," a specification by CEPT, for user-to-international network links. West Germany is going ahead with "ISDN services user part" through CCITT. Dawn Hayes, "Planning ISDN: Can the Nations Become United?" in "Grand Designs for ISDN," *CommunicationsWeek. CLOSEUP*, May 2, 1988. See also, P. Slaa, *ISDN As a Design Problem: The Case of the Netherlands* (The Hague: The Nederlandse Organisatie voor Technologisch Aspectenonderzoek, March 1988).

<sup>74</sup>Wigand, op. cit., footnote 61, p. 38.

<sup>75</sup>*Ibid.*

<sup>76</sup>Hayes, op. cit., footnote 73, p. C4.

<sup>77</sup>For a comparison of early interest, see Wigand, op. cit., footnote 61.

munication services.<sup>78</sup> This perception was bound to work against ISDN, insofar as the United States was just beginning to move away from the integrated Bell System towards divestiture and deregulation at the time when the idea of ISDN was gaining momentum in Europe.

To the extent that discussions about ISDN have occurred in the United States, they have generally taken place in technical rather than in political forums. National ISDN standards are developed, for the most part, by ANSI's TIS1 subcommittee, one of six subcommittees that comprise the larger T1 committee sponsored by the Exchange Carriers Standards Association (ECSA). This is a trade association of U.S. communication carriers and suppliers that was founded after divestiture, and subsequently received accreditation for its T1 Committee from ANSI.<sup>79</sup> Once the T1 S 1 subcommittee agrees on recommendations, it sends them to the T1 Committee. After reaching a consensus, the T1 Committee forwards them to the Department of State, which forwards them to CCITT as representing the official, unified U.S. position.<sup>80</sup>

In keeping with the U.S. tradition of developing voluntary consensus standards, the Federal Government has not been deeply involved in setting ISDN standards. The FCC has intervened, however, in the few cases—such as that of the “U” interface—when

it appeared that international ISDN standards developments might have anticompetitive consequences.<sup>81</sup> More recently, NIST has established the North American ISDN User's Forum. This is intended to provide users with a platform for voicing their needs for standards, and to facilitate the development of implementation standards by bringing users and vendors together.<sup>82</sup>

To date, State governments and State regulators have not shown much interest in the issue of ISDN standards. Their involvement, however, may become greater in the future, as ISDN tariffs begin to be filed.<sup>83</sup> The New York State Public Service Commission, for example, recently held a major inquiry on the subject.

The responsibility for reconciling conflicting national ISDN standards on a worldwide basis rests with the CCITT, the standards-setting arm of the International Telecommunications Union. In November 1988, the CCITT plenary session, held in Melbourne, Australia, unanimously accepted the Basic and Primary rate interfaces that had been under discussion since the last plenary session held 4 years before. Discussion groups are now turning their attention to the proposed broadband standards, which are scheduled to be presented to the 1992 plenary session for ratification.<sup>84</sup> One major breakthrough with respect to broadband ISDN was the

<sup>78</sup>See Noam, “The Political Economy of ISDN,” op. cit., footnote 2, p. 38; see also, Lehr, op. cit., footnote 68.

<sup>79</sup>“ISDN,” *Data Communications*, December 1987, p. 52. In the United States, most commercial standards are voluntary standards developed through consensus proceedings in nonprofit, nongovernmental organizations. ANSI is the organization in the United States that has the major responsibility for developing national standards. ANSI, itself, does not make standards; it endorses groups of experts and the processes by which standards are arrived at. Among those involved in ANSI proceedings are the Electronic Industries Association, the Institute of Electrical and Electronics Engineers, and NIST. For a discussion, see Hack, op. cit., footnote 1, pp. 8-9.

<sup>80</sup>*Ibid.*

<sup>81</sup>Noam, “The Political Economy of ISDN,” op. cit., footnote 2, pp. 40-41. It was at this end, for example, that the FCC, in August 1983, issued a Notice of Inquiry (Docket 83-841). As described by Noam: “Its goals were both to generate comments on the FCC's role in ISDN and to stimulate interest in the policy discussion on ISDN itself. The first report, issued in April 1984, restate[d] the FCC's intention for a limited role. It set, however, several policy principles for ISDN design: a flexible numbering plan that permits user choice of carriers, domestically and internationally; . . . and no limitation of satellite hops in international connections. Secondly, the FCC declared that customer provision of the network termination device (NT1) should be a national option and asked for comments on the definition of the so-called “U” interface point between the customer premises equipment and the network. Thirdly, the FCC described as fundamental that CCITT recommendations must be flexible for national options, and that the American distinction between basic and enhanced services be maintained.” The FCC examined ISDN again in its 1986 Report and Order on Computer III, which probed the relationship between ISDN and the FCC's comparably efficient interconnection (CEI) proposals, concluding that any problems that might emerge would be manageable.

<sup>82</sup>U.S. Department of Commerce, Press Advisory, “NBS, Industry Form ISDN User's Forum.” The Forum consists of two workshops: one for ISDN users and one for ISDN implementors. The User's Workshop is set up to develop requirements for specific business applications for ISDN, whereas the Implementor's Workshop will prepare specification agreements necessary to implement the applications. The activities within the two workshops are being coordinated by the North American ISDN User's Forum Executive Steering Committee. Contributing to the work of the forum is the OS1 Implementor's Workshop and the Corporation for Open Systems. Also involved are user organizations (such as General Motors) that have been deeply involved in the development of MAP (Manufacturing Automation Protocol).

<sup>83</sup>Lou Feldner, FCC, personal communication.

<sup>84</sup>Keith Newman, “ISDN Standards Ratified,” *Computerworld*, Dec. 19, 1988, p. 45.

recent agreement on Synchronous Optical Network (SONET), the international optical-interface standard or, more specifically, the Network to Network Interface (NNI) for B-ISDN.<sup>85</sup>

Although the CCITT has clearly been moving forward in developing ISDN standards, the lengthiness of the process may, in the long run, actually make it more difficult to achieve interoperability and to gain user acceptance for ISDN. For example, many companies—as well as countries—are now building their competitive strategies around the existence of ISDN, and the likelihood of an evolutionary, technological development towards it. To execute these strategies, and to attract future customers, they need to begin now to develop products and test them in trials. These efforts need to be undertaken despite the fact that, in many cases, application specifications and implementation standards are as yet undefined. It would be unfortunate if, as a result, vendors were to develop a number of products that are purported to be designed to ISDN standards, but are actually incompatible with one another.<sup>86</sup> This would dampen users' interest in ISDN, an interest that is still somewhat skeptical at best.<sup>87</sup> A second problem might be that regional standards-setting bodies may begin to supersede CCITT in setting standards, generating centrifugal forces in the international standards-setting arena.<sup>88</sup>

Also stemming the tide towards the development of ISDN standards is the fact that, like any standards-setting, the advantages and disadvantages to be derived will not be distributed evenly among stakeholders. Among the key U.S. beneficiaries of the early adoption of ISDN standards will be AT&T and the regional Bell operating companies (RBOCs). As discussed in chapters 5 and 12. AT&T and the

RBOCs will need to continually upgrade, and add intelligence to, their networks if they are to successfully compete with other communication providers for the lucrative business-user and prevent further bypass. To do this, ISDN is essential. Together with signaling system 7 (SS7), ISDN will permit telephone companies to allow customers to tailor their communication circuits on public networks in much the same fashion as they do now on private networks.<sup>89</sup> As one observer has described the relationship between ISDN and the competitive prospects of the RBOC and AT&T:

... from a purely strategic standpoint, it came as no surprise to see both AT&T and the BOCs enthusiastically embrace the concept of ISDN in the aftermath of divestiture, sensing the potential for both real or virtual remonopolization and the need to regain marketing initiatives towards the large corporate user—the lack of which was the short-term price of the complicated trade-offs inherent in divestiture.

Most especially, ISDN became important because it offered a universal scheme whereby significant new functionality for both voice and data (and possibly even higher bandwidth applications such as video) could be offered to corporate customers but be controlled and managed via AT&T and BOC custody of the public networks. This was reinforced by the realization that unless they moved to create these new levels of both network intelligence and control for their customers, they would lose serious competitive advantages as corporate users plunged ahead with their private networking efforts.<sup>90</sup>

While most vendors have publicly declared their intent to move towards ISDN standardization, they have not been uniformly supportive of its development. Many private network vendors, such as those selling T1 multiplexer and PBXs, are fully aware of

<sup>85</sup>This agreement represented an important breakthrough because the SONET standard, which was developed in the T1 committee of the Exchange Carriers Standards Association, was initially opposed by both the Japanese and the Europeans. The compromise specification is based on SONET, but has additional capabilities to allow it to deal with the European 2-MBps digital hierarchy. For a discussion see, Rodney J. Boehm, "SONET: An International Standard," *Telecommunications*, March 1988, pp. 73-76; Rodney J. Boehm, "SONET: A Standard Optical Interface Emerges," *Telephony*, Apr. 4, 1988, pp. 54-57; and Alistair Henderson, "Into the Synchronous Era," *Telecommunications*, December 1988, pp. 29-33.

<sup>86</sup>See, Byron Belitsos, "Competition Threatens Progress of ISDN in the USA," *Communications International*, October 1986, p. 29; and Sarah Underwood, "ISDN On Trial," *Datamation*, Feb. 1, 1987, pp. 53-56.

<sup>87</sup>See, for example, Clare Lees, "ISDN—User Doubt and Tariff Issues," *Telecommunications*, April 1988, pp. 56-63; John Foley, "ISDN Haves Early User Hanging," *CommunicationsWeek*, July 4, 1988, p. 39; and Warren S. Gifford, "ISDN Performance Trade-Offs," *Telecommunications*, April 1988, pp. 65-68.

<sup>88</sup>In recognition of this possibility, CCITT adopted a number of reforms at its November 1988 meeting, which are designed to accelerate the approval procedure. Gilhooly, *op. cit.*, footnote 34.

<sup>89</sup>Stuart Zipper, "Telecom Firms Arm vs. RBOCs in Bid for ISDN, SS7 Public Net Market," *Electronic News*, Oct. 5, 1987.

<sup>90</sup>Tom Valovic, "Public and Private Networks: Who Will Manage and Control Them?" *Telecommunications*, February 1988, pp. 42-45.



the potentially negative impact that ISDN can have on their competitive position vis a vis the regional Bell companies and AT&T<sup>91</sup> With this in mind, they have rushed to sell their products, thereby locking up customers for private digital networks before ISDN and SS7 can become a reality on the public network.<sup>92</sup> Some of the large vendors of switches are employing a mixed strategy—pressing to sell now to private networks, but planning to be the primary suppliers of ISDN switches in the future when a market for ISDN services emerges.<sup>93</sup> While IBM was initially slow to warm up to ISDN, it has recently become a much greater supporter. ISDN is now an important part of IBM's strategy to become a key provider in the telecommunication networking market. One additional factor that was clearly important in changing IBM's stance on ISDN was its desire to sell its networks in Europe, where standardization with the public networks is essential.<sup>94</sup>

Most large users have yet to become enthusiastic about ISDN. Because the kind of functionality they need is still along way off in an ISDN environment, they are developing their own private networks, using the T1, T3, and local- and wide-area network technologies that are available to them at the present time.<sup>95</sup> Many question whether ISDN will ever be more cost-effective than their existing networks, given the magnitude of their data needs and, hence, the tremendous economies of scale they enjoy.<sup>96</sup> In addition, as other networking standards are developed and private networks themselves serve to integrate voice and data, ISDN may prove redundant.<sup>97</sup> As a result, whereas large users have been

strong proponents of the move towards OSI standards, they have not been as active in the ISDN standards-setting process. Their most important input to date has come from their participation in the ISDN User's Workshop established by NIST<sup>98</sup>

Small-business, residential, and rural users may actually have a much greater stake than large users in the timely development of ISDN standards. As described in chapters 5 and 8, they do not have the resources, nor do they enjoy the economies of scale and scope, that are required to establish and manage a private communication network. Thus, without ISDN, they will not have access to many of the economic advantages that new technologies afford. Notwithstanding the potential value of ISDN to these users, they have played a very small role, if any, in the ISDN standards-setting process.

In considering whether Congress should take additional steps to encourage the ISDN standards-setting process, certain questions and answers need to be kept in mind. These appear in table 11-1.

### Open Systems Interconnection

Open systems interconnection (OSI) is an architecture for computer networks and a family of standards that permits data communication and data processing among diverse technologies. Like ISDN, OSI-based standards anticipate the development of particular applications or products. They provide a reference model that defines and categorizes seven layers of functions that need to be performed in any computer network if effective communication is to take place, as well as the protocols and services at

<sup>91</sup>As one PBX vendor described the competitive situation, given ISDN, it will be all too easy for third-party vendors to attach their voice and data devices to proprietary PBX systems. "Why should vendors go through the R&D expense of developing and implementing the standard [on their products] when someone else can come out with a nicer terminal to plug into their PBX?" as cited in, Elizabeth Horwitz and Kathy Chin Leong, "PBX Vendors Pressured For ISDN Links," *Computerworld*, Sept. 12, 1988, p. 80.

<sup>92</sup>Ibid; see also, Valovic, op. cit., footnote 90; and Joseph Brau, "1987: The Year When Networking Became Part of the Bottom Line," *Data Communications*, January 1988.

<sup>93</sup>Ibid. See also Valovic, op. cit., footnote 90, and Elizabeth Schultz, "PBX Upgrades Travel the Bumpy Road to ISDN," *Telephony*, Nov. 28, 1988, pp. 36-39. The position that AT&T finds itself in is telling. As noted by Steven Titch, having invested so heavily in developing the 53SS switch, AT&T has a tremendous interest in seeing ISDN come to market. However, its aggressive sales efforts have offended many of the BOCs, who have now accused the vendor of failing to support the embedded base of IAESS. Steven Titch, "Network Gear," *CommunicationsWeek*, December 1988, p. C10.

<sup>94</sup>Barbara Depoma, "Into ISDN in a Big Way: Once a Skeptic IBM is Quickly Becoming a Major ISDN Proponent," *CommunicationsWeek*, Oct. 26, 1987.

<sup>95</sup>Valovic, op. cit., footnote 90.

<sup>96</sup>T. Marvin Waltrip, "ISDN and the Large Corporation: Is ISDN the Best Solution for Big Telecom Users in the Corporate World? Maybe No," *Telephony*, May 9, 1988.

<sup>97</sup>Ibid.

<sup>98</sup>John Foley, "Users Demand Role in ISDN," *CommunicationsWeek*, June 13, 1988, pp. 1, 70. Among the major ISDN problems remaining that were cited by users were the ISDN numbering plan, wiring standards, substrate adoption, and equipment incompatibility.

**Table 11-1--Integrated Services Digital Network: Factors Affecting the Choice of Federal Options**

1. Apart from the value to individual stakeholders, of what value is the setting of standards in this area from a societal perspective?	Important for maintaining the viability of the public switched network. For reasons of equity, so as to assure that the new information services are available to residential users, to small businesses, and in rural areas.
2. What is the cost of waiting for standards to be developed in the marketplace or through a voluntary consensus process?	In the case of ISDN standards, there is some danger that, given the growing competition among vendors, proprietary solutions will be implemented before specifications can be adopted and products implemented to conform to them. There is a danger also that U.S. standards, and the U.S. standards-setting process, will become out of sync with international standards developments, with negative consequences for the communication industry.
3. How likely is it that, in the absence of government intervention, de facto or voluntary standards will be adopted in the near term? a. To what extent do vendors share a common interest in developing standards and agree on the appropriate standard? b. To what extent are users eager to standardize? Do they agree on a standard? What leverage do they have vis a vis vendors in the marketplace?	Not likely, given the lack of user demand and the uncertain market for ISDN products. Vendors have all committed to conforming to ISDN narrow band standards, although some have greater stakes in these standards (AT&T, the RBOCs) than do others (IBM, providers of T1 multiplexer, other system integrators). Competition among vendors is extremely intense. Many users, especially large users, remain unconvinced about the value of ISDN, although interest in ISDN products is clearly growing.
4. To be effective in promoting standards, what level of government involvement would be required? How far would the Federal Government need to go in the direction of setting standards? What kinds of government involvement might be appropriate?	Moderate effort. Greater technology/R&D support. Support for broader public policy input into the standards-setting process. Increased coordination of U.S. position on ISDN for presentation at international standards-setting fora.
5. How susceptible are standards to technological change? How many possible options or choices of standards are there?	Moderately susceptible to change. Integrated approach attempts to allow for compatibility over time. However, the time required for moving towards B-ISDN appears to be getting shorter and shorter.

SOURCE: Office of Technology Assessment, 1990.

each layer (see figure 11-3).<sup>99</sup> These layers are designed to be independent of one another so that altering one layer will not require alterations in others.<sup>100</sup> These seven layers are, themselves, generally divided into three groups:

- the four lower layers (physical, data linking, networking, and transport), which handle the interconnections of end systems;
- layers 5 and 6 (session and presentation), which support the exchange of information between

end systems using data transfer facilities provided by the transport service; and

- layer 7, the applications layer, which provides for interworking between applications processes in end systems.<sup>101</sup>

Like ISDN, OSI-based standards are international in scope and are being developed in international standards-setting bodies. However, whereas ISDN

<sup>99</sup>Hack, op. cit., footnote 1, p. 15. See, for a further description and discussion, Harold C. Folts, "A Tutorial on the Interconnection Reference Model," *Open Systems Data Transfer 2-21*, June 1982. Reprinted in William Stallings (ed.), *Computer Communications: Architecture, Protocols, and Standards* (Silver Spring, MD: IEEE Computer Society Press, 1985).

<sup>100</sup>Hack, op. cit., footnote 1. See also, Bryan Wood, "Standards for OSI—Present Status, Future Plans," *Telecommunications*, March 1988, pp. 32-36.

<sup>101</sup>Ibid.

standards are being established by CCITT, OSI standards are being worked out by the Joint Technical Committee 1 (JTC1)<sup>102</sup> of ISO and the International Electrotechnical Commission (IEC).<sup>103</sup> Although CCITT and ISO cooperate in setting standards<sup>104</sup>—and ISDN is being developed to conform to the OSI reference model—there are some important differences between the two organizations. These are sometimes reflected in how stakeholders perceive the standards-setting processes and the standards that emerge from them.<sup>105</sup> Developed to coordinate telecommunication among nations, CCITT is a treaty organization whose decisions are binding on its signatories. ISO, on the other hand, evolved in response to the market need for standards; thus, it is a voluntary organization that develops standards through a consensus-building process, and its decisions are not binding on the participants.<sup>106</sup>

Just as the European nations provided the initial support for ISDN, they were also quite prominent among the original supporters of OSI, and for much the same reason. The Europeans were eager to prevent the further consolidation of IBM's control of network standards through SNA, its proprietary network model.<sup>107</sup> But unlike ISDN, the demand for

OSI among users, both in the United States and Europe, was quite high. This demand reflected an appreciation of the need for computer interconnectivity to keep pace with the enhanced role of information and communication in a service-based economy.<sup>108</sup>

The development of standards for OSI is now maturing as a process, both with respect to the evolution of the standards themselves and in terms of their use in information technology systems and related equipment.<sup>109</sup> Considerable progress has been made since ISO published its first OSI documents. The standards for levels 1 through 6 are quite well developed. Although some applications standards for level 7 still need to be set, during the past year the progress in this area has been quite impressive.

Looking at these developments, most observers agree that, over the long term, the move to OSI standardization is inevitable.<sup>110</sup> However, there is much less agreement about when and how this will come about. There are still a number of obstacles to full implementation of OSI, and considerable uncertainty with respect to how these might be overcome.

<sup>102</sup>The Joint Committee is made up of the information technology committees of the ISO and the International Electrotechnical Commission, a voluntary standard-setting body that is devoted to developing electrical and electrotechnical standards. To avoid a growing competition between these two organizations for the responsibility of setting computer standards, the information technology activities of these two groups were merged in 1987.

<sup>103</sup>The International Standards Organization was established in 1946 by delegates from 64 countries. Similar to ANSI, the ISO is a nongovernmental, voluntary institution. There are presently 72 "full members" of the ISO representing national standards associations, such as ANSI. In addition, there are 17 "correspondent members," representing governmental institutions from countries that do not have national standards bodies. Besen and Saloner, *op. cit.*, footnote 1, pp. 14-15. See, for a further description, Edward Lohse, "The Role of the ISO in Telecommunication and Information Systems Standardization," 23 *IEEE Communications Magazine*, January 1985, pp. 18-24.

<sup>104</sup>The CCITT has been involved in setting some data communication standards, the most important of which was CCITT Recommendation X.25 for packet switching. Unlike the OSI standards, the CCITT data communication standards were developed on an ad hoc basis and not as part of a grand design that would provide compatibility of different protocols and system architectures. Besen and Saloner, *op. cit.*, footnote 1, pp. 17-18.

<sup>105</sup>Carl Cargill, Senior Standards Consultant, Digital Equipment Corp., personal communication, Mar. 13, 1989.

<sup>106</sup>*Ibid.* To become a Draft International Standard, a proposal must have the approval of 75 percent of those participating in a relevant technical committee. These draft standards become international standards once they have been adopted by the Council of the ISO. Besen and Saloner, *op. cit.*, footnote 1, pp. 15-16.

<sup>107</sup>Hack, *op. cit.*, footnote 1, p. 17. SNA, which was developed by IBM in 1974, provides a layered architecture similar to that of OSI, with the highest layer—equivalent to OSI's Layer 7—being served by several IBM applications, including Systems Network Architecture Distributed Service (providing store-and-forward facilities), Distributed Office Support Systems (providing centralized document storage and distribution services), and Document Interexchange Architecture/Document Content Architecture (providing support and defining the format for document transfer across the network). SNA strengths are that it is now available and supported by IBM and virtually every major computer vendor. It has an installed base of 40,000 networks worldwide, is coherent, and its extensions appear to promise a substantial gain in functionality. For a discussion, see DeBoever, *op. cit.*, footnote 20.

<sup>108</sup>Some observers have described the stake for users: "The rapid implementation and growth of data communication systems in recent years has left far too many users and suppliers unable to adequately design, control, and deploy and manage networks. Because product standardization remains more theory than practice, mismatched equipment and islands of incompatible networks are preventing too many companies' various departments and branches from sharing data. That's too bad, because the data invariably represents vital information, which the companies could use to do a better job at whatever business they are in, if only interpremises networking weren't such a devilishly difficult game." Titch, Semilof, and Berrigan, *op. cit.*, footnote 17, p. m.

<sup>109</sup>For a discussion, see Wood, *op. cit.*, footnote 100.

<sup>110</sup>Timothy Haight, "O Say Can You See OSI Yet," *CommunicationsWeek*, CLOUSEP June 6, 1988, pp. C10-C14.

**Figure 11-3--OSI Reference Model**

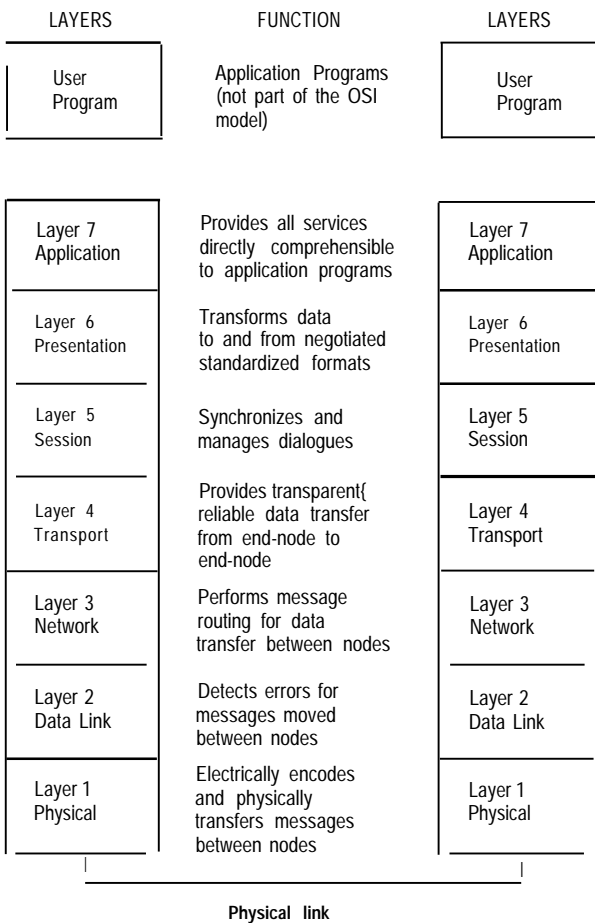

SOURCE: National Institute of Standards and Technology (Formerly National Bureau of Standards),

One obstacle already noted is the lack of application standards. It is at the level of applications, layer 7, where the greatest functionality is provided. This is where choices are made about how to treat a communication-as a file transfer, a virtual terminal session, or a computer-aided design.<sup>111</sup> And, in line with this choice, it is at layer 7 that the protocols in the 6 lower layers that are required to execute this function are automatically selected. Now that the 6 bottom layers of the OSI reference model are near completion, the application layer is expected to grow dramatically, in number as well as usefulness. There is, however, still much to be done.<sup>112</sup>

In addition to defining the seventh layer of the OSI reference model, further steps also need to be taken to specify standards for specific environments, as well as to implement products that conform to these specifications.<sup>113</sup> Without such specifications, there is a strong possibility that vendors will, in the meantime, develop incompatible, proprietary interfaces. The problem, however, is in getting this process under way. As Haight has described it:

Products to interconnect many different computers via OSI may not be released until vendors see the market, which may not exist until users see applications . . . which may not be written until software developers see OSI on enough systems to be sure that a market will exist. . . <sup>114</sup>

Another major question that needs to be resolved is how the migration to OSI will take place.<sup>115</sup> Competing with OSI as a networking standard are IBM's SNA, and TCP/IP,<sup>116</sup> which was developed in the late 1960s with the support of the Department of Defense. Some companies have already invested heavily in these other networking products, and they

<sup>111</sup>Evelyn Roux, "OSI's Final Frontier: The Application Layers," *Data Communications*, January 1988, pp. 137-See also, Lee Mantelman, "Upper Layers: From Bizarre to Bazaar," *Data Communications*, January 1988, pp. 110-128.

<sup>113</sup>Helen Pike, "Will TCP/IP Wither on the Vine?" *Computerworld*, Sept. 7, 1988, pp. 27-30.

<sup>114</sup>Haight, *op. cit.*, footnote 110.

<sup>115</sup>For a discussion, see *ibid.*; see also, pike, *op. cit.*, footnote 113, pp. 27-30; and Elizabeth Horwitt and Patricia Kefe, "Firms Forecast OSI Migration Plans," *Computerworld*, Nov. 7, 1988.

<sup>116</sup>TCP/IP was the first peer-to-peer protocol developed for multivendor environments. Today, TCP/IP support is available for most processors, and this is its chief strength. For the long term, however, it is considered by many to be outdated and incomplete. For a discussion, see DeBoever, *op. cit.*, footnote 20; see also, Haight, *op. cit.*, footnote 110; and Pike, *op. cit.*, footnote 113.

are unsure about what their next steps should be.<sup>117</sup> Their choices are quite numerous—perhaps so numerous as to be overwhelming.<sup>118</sup> But not making a choice can be very costly for users. Also, if many users fail to act, the move towards OSI standardization would certainly be curtailed. Depicting the dilemma faced today by users, and the potential consequences for standardization, one trade journal notes, for example:

For many organizations, the network has become a leviathan, clumsily adrift in a sea of equipment from a fleet of vendors. With each passing day, these networks grow more cumbersome for users to manage and vendors to keep afloat. If not brought under control soon, such networks may become impossible to streamline—either because the unifying technology doesn't exist or because integrating all the pieces would be prohibitively expensive . . . . As companies continue to grow and diversify, it becomes increasingly difficult to create corporate standards.<sup>119</sup>

Vendors also find themselves in a difficult situation with regard to OSI. They all recognize the need to provide connectivity and interoperability, given the growing user demand. To effectively compete to do so, however, means becoming a “total solution” provider. Taking such a step can be quite costly, entailing:

- . in-house research and development;
- . the acquisition of companies with specialized skills; and
- . the development of strategic alliances with vendors who can offer complementary skills and products.<sup>120</sup>

Not only will companies have to build bridges and move towards OSI; they will also have to provide support for their old network architecture, at least during the transition, as well as provide interfaces to IBM's latest extensions to SNA—all the while offering high functionality and efficiency.<sup>121</sup> Not all vendors will be able to acquire the resources necessary to execute such a strategy, especially since, as a result of standardization, many traditional communication products—PBXs, T1 multiplexer, and modems—are beginning to resemble commodities, drawing in narrower and narrower profit margins.<sup>22</sup>

Despite these difficult problems, there are a number of reasons for being somewhat optimistic about the future of OSI standards. Users, for example, continue to be very active, and very effective, in pressing for OSI interconnectivity. Recent surveys of Fortune 1000 companies indicate that more than 50 percent intend to use at least some OSI-based networks by the early 1990s.<sup>123</sup> In 1986, a number of vendors and some users joined together to form the Corporation for Open Systems, whose purpose is to develop conformance testing tools and procedures to aid vendors and users. In addition, user and vendor working groups and organizations have developed to define specifications of more general protocol definitions. To this end, for example, Boeing Corp. successfully took the lead in generating the Technical and Office Protocol (TOP) initiative, while General Motors did the same for the Manufacturing Automation Protocol (MAP).

<sup>117</sup>For a discussion see, Christine Bonafield and Paul L. Korzeniowski, “Neither Standards, Nor Understanding,” *CommunicationsWeek, CLOSEUP*, Sept. 12, 1988, p. C10. As noted: “Within corporations that employ data networks . . . senior management often is reluctant to invest in complex new technologies—either because the decision-makers don't recognize the potential benefits or because these executives worry that the technology will become too quickly outmoded. Within many vendor and user companies alike, moreover, there's often a culture gap. The staff assigned to *designing*, implementing and administering local area networks may not be the same group of people who oversee wide area networks. Under such circumstances, network integration doesn't happen naturally, if at all. And within the communications industry in general, the networking technology and concepts are so complex that few organizations are able to find and retain enough people sufficiently skilled to cope with the challenges.”

<sup>118</sup>As outlined by Haight: “According to the people at the crossroads, there is no singular smooth migration path. There are at least six. The way to OSI can lead through gateways, either at the applications or at the transport level. It can wind through dual protocol stacks, located either at a host computer or at a workstation. Finally, some say the answer is writing OSI applications on top of TCP/IP transports, while others say exactly the reverse, putting applications now used with TCP/IP onto OSI transports.” Haight, *op. cit.*, footnote 110, p. C1 1.

<sup>119</sup>Titch, Semilof, and Berrigan, *op. cit.*, footnote 17.

<sup>120</sup>Bonafield and Korzeniowski, *op. cit.*, footnote 117.

<sup>121</sup>Dale Kutnick, “OSI A High Stakes Game to Play,” *Computerworld*, Sept. 12, 1988, p. 19.

<sup>122</sup>*Ibid.*; see also, Bonafield and Korzeniowski, *op. cit.*, footnote 117.

<sup>123</sup>Kutnick, *op. cit.*, footnote 121, p. 19.

One of the most prominent of the user groups working on behalf of OSI is the U.S. Government.<sup>124</sup> After 10 years of providing general support for OSI standards, the U.S. Government has recently developed the Government Open Systems Interconnection Profile (GOSIP), a specification that is compatible with industry specifications for OSI.<sup>125</sup> Moreover, in 1983, when it became increasingly obvious that the OSI standards-setting process was becoming bogged down for lack of specifications, the National Bureau of Standards (now the National Institute for Standards and Technology, or NIST) organized a workshop for implementors, which is held five times annually. The workshop is an open international forum, representing more than 200 computer manufacturers, semiconductor manufacturers, word-processing vendors, process control vendors, communication carriers, and industry and government users from the United States, Canada, and Europe.<sup>126</sup>

Also creating an impetus for OSI is the further development of layer 7 applications standards. For example, two crucial OSI applications--Directory Services (DS) and Virtual Terminal (VT)--are scheduled to be approved by ISO by the end of this year. While these standards are being brought forward for approval, some vendors have formed an industry support group to develop standard interfaces between these OSI protocols. Comprised of 12 industry members, this group will initially develop standard programming interfaces between OSI's messaging standard (X.400) and software applications for OSI, such as spread sheets and electronic mail.<sup>127</sup>

Taking all of these factors into account, some observers of the standards scene look to the future and predict that OSI and SNA will provide dual standards for computer networking that serve to complement, rather than compete with, one another--although the cost of interconnection may not be trivial.<sup>128</sup> Others are less sanguine. Concerned that competition among vendors to become the dominant system integrator will forestall the move towards interoperability, some have even suggested that the government play a more active role in facilitating the transition to OSI.<sup>129</sup> In assessing what role Congress might play in this regard, certain questions and answers, which serve to summarize the discussion above, need to be taken into account. These are listed in table 11-2.

### Open Network Architecture

As a key component of the FCC's Computer 111, Phase 1 Decision, Open Network Architecture (ONA) is the network design conceived by the FCC to assure that enhanced service providers could gain equal access to exchange carriers' networks for the purpose of implementing new services.<sup>130</sup> The underlying idea was that, if the Bell Operating Companies could provide their competitors equal access to their networks, they would no longer be required to provide enhanced services through separate subsidiaries.<sup>131</sup> To assure that such access would be available, it was necessary to make the telephone companies' basic network services (referred to as Basic Service Elements, or BSEs) available in a uniform fashion.

<sup>124</sup>Within the government, NIST has responsibility for helping agencies to implement OSI.

<sup>125</sup>The Department of Defense has taken the lead in requiring GOSIP in future network acquisitions, having issued a policy statement in 1987 outlining a 2-year transition from TCP/IP to OSI. Shirley M. Radack, "U.S. Government Moves Towards Implementing OSI Standards," *Standards*, Department of Commerce, pp. 82-83.

<sup>126</sup>*Ibid.*

<sup>127</sup>Kelly Jackson, "New Applications Move OSI Closer to Implementation," *CommunicationsWeek*, Nov. 4, 1988, p. 31.

<sup>128</sup>DeBoever, *op. cit.*, footnote 20.

<sup>129</sup>See, for example, Timothy H@, "Industry Standards: The Book, The Movie," *CommunicationsWeek*, June 13, 1988, p. 20.

<sup>130</sup>As defined b, Computer III, "ONA is the overall design of a carrier's basic network facilities and services to permit all users of the basic network, including the enhanced service operations of the carrier and its competitors, to interconnect to specific basic network functions and interfaces on an unbundled and equal access basis."

<sup>131</sup>According to one account, the concept of ONA stemmed from an Ameritech proposal to develop a concept called Feature Node/Service Interface (later to be called Intelligent Network 2), which would permit exchange carriers to program their own switching machines. Ameritech's suggestion to the FCC that, if such a capability were made available on an equal basis to the exchange carriers competitors there would no longer be a need for separate subsidiaries, was the seed from which the ONA idea evolved. However, telephone companies now avoid associating ONA with the Intelligent Network 2, since the technology to execute such capabilities is still a number of years away. See, for a discussion, John G. Williams, "ONA and the Future of Exchange Networks," *Telematics*, vol. 5, No. 8, August 1988, pp. 1-6; See also, Henry Levine, "Implementing Open Network Architecture: Will Push Ever Come to Hug?" *Telematics*, vol. 4, No. 12, December 1987, pp. 3-6." In appreciating this account, it should be remembered that the idea of achieving a common general network model that would allow for inflexible interconnection and interoperation with all other networks was already in the air, with the study of ISDN and OSI. See A.M. Rutkowski, "Open Network Architectures: An Introduction," *Telecommunications*, January 1987, pp. 30-40.

**Table 11-2-Open Systems Interconnection: Factors Affecting the Choice of Federal Options**

<p>1. Apart from its value to individual stakeholders, of what value is the setting of standards in this area from a societal perspective?</p>	<p>Important to support strategic use of communication technologies by the business community, and to foster service-based economy. Important for industry structure, insofar as the cost of gateways and other forms of system integration are not trivial, and may not be affordable to small- and medium-sized businesses.</p>
<p>2. What is the cost of waiting for standards to be established in the marketplace or through a voluntary, consensus process?</p>	<p>There is some danger that, given the intense competition among vendors, proprietary solutions will be implemented before specifications can be adopted and products implemented to conform to them.</p>
<p>3. How likely is it that, in the absence of government involvement, de facto or voluntary standards will be adopted in the near term?              a. To what extent do vendors have a common interest in standardization and agree on the appropriate standard?              b. To what extent are users eager to standardize? Do they agree on a standard? What leverage do they have vis a vis vendors in the marketplace?</p>	<p>Increasingly likely, given the pressure and leverage of large user groups. Possibility for dual standards.              All vendors are moving to support OSI. Continued support for IBM's System Network Architecture also likely, given size of installed base.              Most vendors plan to move towards OSI. Migration strategies differ, however. Eager for standards and migratory solutions. Considerable market power.</p>
<p>4. To be effective in fostering standardization, what level of government involvement would be required? How far would the Federal Government need to go in the direction of mandating standards? What kinds of government involvement might be the most appropriate in this regard?</p>	<p>Low to moderate effort. Greater technology/R&amp;D support. Support for broader public policy input into standards process. Continued facilitation of user/vendor interaction.</p>
<p>5. How susceptible are standards to technological change?</p>	<p>Moderate. Integrated approach tends to allow for compatibility over time. No apparent rival approach on the horizon.</p>

SOURCE: Office of Technology Assessment, 1990

As described by Besen and Saloner, ONA creates standards requirements in two different respects:

Both the interfaces with the basic service elements and the number and nature of these elements are standards issues. The first involves an obvious standards concern since the design of these interfaces will determine whether a competing supplier can employ a particular element in offering his service. Less obvious is why the second is a standards issue. If components can be obtained only on a bundled basis, the interface between them is completely inaccessible to the competing supplier. But the economic effect of an inaccessible interface is exactly the same as if it were accessible but incompatible with the supplier's equipment. Providing components only on a bundled basis is the limiting case of interoperability.<sup>132</sup>

In contrast to OSI—where the impetus for standardization stemmed, to a large extent, from the activities of the marketplace—the Federal Government has been the primary moving force in ONA standards, with ONA becoming the cornerstone of the FCC's deregulatory policy.<sup>133</sup> To achieve its ends, however, the government did not become directly involved in setting standards, or even provide much guidance; rather, in its Computer III orders, it called on the RBOCs to meet with the competitive enhanced service industry in an ONA Forum Process.<sup>134</sup> Lacking expertise in advanced architectures, the FCC left many ONA details to be worked out by the industry players involved.<sup>135</sup> It called for the filing of plans by February 1, 1988, merely stating that its approval of them would

<sup>132</sup>Besen and Saloner, op. cit., footnote 1, pp. 40-41.

<sup>133</sup>It should be noted that this is not the first time that the Federal Government has used standards to promote competition and deregulation. As part of the Carterfone decision, for example, all terminal equipment was required to be connected through standard plugs and jacks. Similarly, the Modified Final Judgment, which requires that the Bell Companies provide equal access, prohibits them from employing technical standards or network plans to discriminate against users. For a discussion, see *ibid.*, pp. 38-40.

<sup>134</sup>Report and Order, CC Docket No. 85-229 (released June 16, 1986) at paragraph 217.

<sup>135</sup>According to Rutkowski, the FCC believed that: "private standards organizations, such as the [ECSA] T1 Committee, should play a major role in resolving relevant standards issues that may arise among carriers and enhanced service providers participating in enhanced service markets." Op. cit., footnote 131, p. 34.

depend on the extent to which they met the requirement of Comparably Efficient Interconnection (CEI)--that is, interconnection on an equal access basis. Not much consideration was given to the role of the States in the ONA process. However, the FCC did point out the difficulty involved in differentiating between intrastate and interstate service elements, and suggested that if jurisdictional differences were to occur, they might be worked out in the Federal/State Joint Board.<sup>136</sup>

The forum process consisted of national meetings conducted with the aid of Bell Communications Research Inc. (Bellcore) and meetings that were sponsored by the individual holding companies. As an additional input into the process, the RBOCs also commissioned studies to be undertaken by the enhanced-service providers, and conducted a number of meetings with users. The first public forum was held in October 1987, and the second in January 1988.<sup>137</sup> Although the participants skirted many of the toughest issues, these forums did serve to initiate a dialogue.<sup>138</sup>

That more was not accomplished at these forums can be explained, in part, by the absence of FCC guidance, by the general "marketing" approach pursued by the RBOCs, and by the discrepancy between the short time period in which participants had to prepare, and the complexity of the problems with which they had to deal. To gain a sense of the complexity of this issue, one need only compare the situation created by ONA to the problems generated by long-distance equal access requirements. As one commentator summarized it:

... equal access required one of the largest mobilizations of manpower and capital the communication industry has ever known. Even before implementation, the government and private sector poured considerable energy into it. . . . And yet, equal access was basically a single application—a network interface developed through discussions between experienced local exchange carriers, and technically sophisticated long distance carriers. . . . By contrast, ONA is not one interface, but dozens---conceivably, hundreds—at many different levels in the network. Wrestling with the concept at industry forums are local exchange carriers less knowledgeable about data than they are about voice, sharing the mat with information service providers of varying sophistication and size.<sup>139</sup>

Given the perpetuation of a number of ONA issues, the RBOCs called for the creation of an Information Industry Liaison Committee (IILC), to be established under the sponsorship of the Exchange Carriers Services Association (ECSA).<sup>140</sup> Its stated purpose is "to serve as an inter-industry mechanism for the discussion and voluntary resolution of industrywide concerns about the provision of [ONA] services and related matters." <sup>141</sup> Although somewhat less formal than other standards-setting committees, the IILC conforms to the voluntary, consensus approach typical in the United States. However, whereas a positive value is generally placed on this approach in other standards-setting bodies, in the case of the IILC it has proved to be a source of some criticism. A number of participants feel, for example, that if the difficult issues are ever going to be addressed, there will have to be greater interest and participation on the part of the FCC.<sup>142</sup>

<sup>136</sup>Ibid.

<sup>137</sup>For a description of the proceedings of this Forum, and the Positions adopted by the participants, see A.M. Rutkowski, M. Gawdun, and N. Merely, "The RBOC'S Views on ONA," *Telecommunications*, January 1987, pp. 43-54; and Amy G. Epstein, "Doubts in the User Community," *Telecommunications*, January 1987, pp. 88-89.

<sup>138</sup>Cathy Clarke, "The Strategic Implications of Open Network Architecture," *Telecommunications*, March 1988, p. 47; see also A.M. Rutkowski, "OpenNetworkArchitectures: A February 1987 Update," *Telecommunications*, March 1987, pp. 79-83. According to most observers, the second meeting was the more substantive of the two. At the first meeting, many of the participants reported that they were distrustful of the proceedings and the intentions of the RBOCs, believing them to be only participating perfunctorily in the forum process. Responding to these concerns at the second workshop, and using Bellcore's Notes on the BOC Intra-LATA Network as a primer, the BOCs shared their views of the network with the other members of the communication industry.

<sup>139</sup>Steven P. NoWick, "For openers . . .," *CommunicationsWeek*, ONA Report, June 29, 1987, p. 4.

<sup>140</sup>According to one observer, the proposal followed a critical comment by Judge Harold Greene, chastising the ECSA for not having yet issued a single standard. See John Foley, "ECSA Establishes New Committee to Meet FCC's ONA Requirements," *CommunicationsWeek*, Oct. 26, 1987, p. 42; for a discussion of the HLC, see Joseph W. Waz, Jr., "inter-Industry Consultation on ONA Plans: Is the IILC the Answer?" *Telematics*, vol. 5, No. 12, December 1988, pp. 1-5.

<sup>141</sup>As quoted in *ibid.*, p. 2.

<sup>142</sup>Ibid.



Participants have also criticized IILC on the grounds that its rules and membership tend to favor the carrier industry.<sup>143</sup>

Building on the common ONA model developed by Bellcore,<sup>144</sup> the forum process, and inputs from groups such as the IILC, the RBOCs filed their ONA plans in February 1988, as required.<sup>145</sup> Common to all plans is the division of the network services into: 1) Basic Service Arrangements (BSAs)—the underlying method of connecting an enhanced service provider to and through the RBOC network; 2) Basic Service Elements (BSEs)—the optional network capabilities such as automatic number identification, which are associated with a particular BSA; and 3) Complementary Network Services—the network functions that allow customers to connect to the network.<sup>146</sup> All plans include essentially the same list of 118 network capability requests made by enhanced service providers. The RBOCs generally agree, moreover, that equal access can be provided without collocation (i.e., physically located within the central office), which some argue would be damaging to the network. They also agree that services should not be technology-driven, but rather developed in response to market demand. The plans differ considerably, however, on a number of fundamental items, including those involving the allocation of costs, pricing, and the order of deploying services.

Not surprisingly, given the RBOCs' hesitancy to use the ONA process to confront fundamental issues, many of the concerns expressed by stakeholders upon review of the ONA plans had already been foreshadowed in previous interactions among the RBOCs and other stakeholders in the communication industry. Considered to be most problematic were: 1) the lack of uniformity among plans; 2) the

inadequate degree of unbundling of services; 3) the failure to provide for collocation; and 4) the bases for establishing costs and, hence, pricing.<sup>147</sup> As one remedy to resolving these problems, many proposed that the FCC take a more active role in the standards-setting process.

The National Telecommunications and Information Administration (NTIA) also took issue with the ONA filings, characterizing them as "an important first step," but "not acceptable as filed." Like an increasing number of others, NTIA called on the FCC to "set forth a definitive set of principles for ONA" and to provide for a "neutral interindustry entity" to work out unresolved ONA issues.<sup>148</sup>

Many State representatives also were displeased with the outcome of the ONA process.<sup>149</sup> Some were concerned about the impact it might have on the public network and on the ratepayer.<sup>150</sup> Others viewed the ONA plans as providing for just one more encroachment by the Federal Government on State jurisdiction. As Gretchen Dumas, principal counsel for the California Public Service Commission, pointed out:

... All these problems and questions for states arise because there is a basic question as to where state jurisdiction is in the midst of this significant change in regulatory practice. . . . The FCC has tried to resolve this problem . . . by finding that the states can regulate any non-enhanced service "use" of a BSE. The problem is how can a state ensure that BSEs are not being used for basic service. . . . the basic thrust of the new FCC policy in Computer 111 is to allow telephone company involvement in enhanced services on a nonstructurally separated basis, to consider such services as competitive and unregulated, and to preempt any state regulation of

<sup>143</sup>Ibid.

<sup>144</sup>The BOC Special Report No. 4, published by Bellcore in November 1987, provided the BOCs with a common basis for communication in planning for ONA.

<sup>145</sup>See Clarke, *op. cit.*, footnote 138; see also, Michael Warr and Ellis Booker, "Comparing the ONA Plans: A First Look," *Telephony*, Feb. 23, 1988.

<sup>146</sup>Ibid.

<sup>147</sup>Anne-Marie Roussel, "Bells ONA Proposals Deemed Unacceptable," *CommunicationsWeek*, May 23, 1988, pp. 42-43. See also, "Collocation Issue Heating Up, Likely to Stall ONA Progress," *Data Communications*, March 1988, pp. 70-74, and Ellis Booker and Deborah Pfeiffer, "Interface '88: A Smoldering ONA Controversy," *Telephony*, Apr. 25, 1988, pp. 38-40.

<sup>148</sup>"RHCs Say ONA Plans Meet FCC Rules: NTIA Calls Rules Insufficient," *Enhanced Services Outlook*, June 1988, p. 3.

<sup>149</sup>See, *et al.*, discussion, Gretchen Dumas, "Open Network Architecture: Equal Access for Enhanced Services," *Telematics*, vol. 4, No. 7, July 1987, pp. 5-7; see also, "Supreme Court Case, FCC Jurisdiction and ONA," *The ESC Monthly Report*, March 1988, vol. 2, p. 3.

<sup>150</sup>Steven Titch and John Foley, "Bell Filings Portend More, Trickier Talks," *CommunicationsWeek*, Feb. 8, 1988, pp. 1, 56."

intrastate enhanced service which is not entirely consistent with FCC policy.<sup>151</sup>

Given the tremendously high stakes involved, it is only natural that the setting of ONA standards would generate such strong controversy.<sup>152</sup> As was intended, ONA will have major impacts on competition in the telecommunication market, redefining the boundaries among market segments, altering barriers to entry, changing the economics of providing services, and restructuring the delivery technologies that are used.<sup>153</sup>

The local exchange carriers will be radically affected by ONA, one way or another. By opening up their networks, they risk exposing themselves to much greater competition. At the same time, they will need to absorb the cost and disruption entailed in implementing their ONA plans. However, if they fail to follow through on ONA, they could lose the opportunity of taking part in developing and profiting from the potentially lucrative information services market. Thus, adopting a company position on ONA has entailed many complex and critical choices, each made under conditions of considerable uncertainty and within a very short timeframe. These decisions will have far-reaching ramifications within the RBOCs, affecting their marketing strategies, regulatory posture, relationship to their competitors, as well as their network plans.<sup>155</sup> As one observer has described this impact:

new services-determined by inputs from the [RBOC] marketing plans—will influence network evolution and planning for open interfaces. . . . The consequences of these decisions, moreover, will have a direct effect on potential revenue, profitability and growth.<sup>156</sup>

Despite these difficult choices, most RBOCs welcomed the ONA process, envisioning it as a significant market opportunity.<sup>157</sup>

Moreover, the ONA process has the potential not only to restructure the telecommunication industry, but also to radically alter major segments of the information services market, ranging from those industries involved with electronic publishing, database retrieval, and voice message storage, to those providing network burglar alarms.<sup>158</sup> Like the local exchange carriers, information service providers face a future fraught with uncertainty. No one knows what the size of the actual market for information services will be, or how information providers should relate to telephone carriers in order to maximize it. Many in the information industry have already made substantial investments in the network architecture as it has traditionally existed, based on existing industry boundaries. As these boundaries change, information providers could find themselves in the wrong business, with technically obsolete equipment and vulnerable to the competition of new and more up-to-date players.<sup>159</sup>

In spite of the controversy surrounding ONA, FCC tentatively approved large portions of the RBOCs' ONA plans, on the provision that some revisions would be made. The ONA process is far from over, however; many outstanding issues remain. Still to be addressed, for example, are the issues of how costs will be allocated and services priced, as well as how jurisdictional authority will be divided between the Federal Government and the States.<sup>160</sup> There also continues to be considerable disparity among the different RBOC approaches to ONA, a fact that, as many have pointed out, undermines the very nature of standards. The one factor that will certainly ensure that ONA remains on the policy agenda for a long time, however, is the rapid pace of technological change. Designed, for the most part, around the technology as it presently exists, the ONA plans will need to be continually

<sup>151</sup>Dumas, op. cit., footnote 149, P. 6.

<sup>152</sup>For a discussion, see Jim Kennedy, "For Whom the Bells Toil," *CommunicationsWeek*, June 29, 1987, pp. 10-11, p. 21.

<sup>153</sup>Ibid.

<sup>154</sup>Ibid.

<sup>155</sup>Ibid. See also, Robin Williamson, "Planning the Right Moves," *CommunicationsWeek*, Special Issue on ONA, June 29, 1987, p. 15.

<sup>156</sup>Ibid.

<sup>157</sup>Ibid.

<sup>158</sup>Jennifer Bater, "Competitive Pull," *CommunicationsWeek*, Special Issue on ONA, June 29, 1987, pp. 17,20.

<sup>159</sup>Ibid.

<sup>160</sup>Clarke, op. cit., footnote 138.

revised to take into account the changes that will come with the Intelligent Network 2 and ISDN.<sup>161</sup>

Although there have been many critics of the ONA process over the past 2 years, most people agree that the idea still has merit. In fact, many would like to see the concept of ONA developed further.<sup>162</sup> In the minds of some, the importance of ONA cannot be overestimated. As one who has thought extensively about the subject described it:

The importance of ONA is tied to the fact that ultimately, if successfully implemented, it will become a gateway between public and private networks and become the means whereby a host of smaller entrepreneurial service providers will gain critical access to the next generation of increasingly software driven and highly programmable BOC super switches. . . . If ONA can be made to work. . . then the same kind of creative explosion that took place in the development of an extraordi-

nary range of PC software and service in the computer industry will finally be free to occur in telecommunications . . . . More importantly, it would allow this type of creative development to be done by those who should be doing it—smaller, creative, and entrepreneurially minded service providers who can then “test run” their services in the open marketplace . . . .<sup>163</sup>

As already noted, many believe that to carry this process further, the government will need to assume a greater role. Others, although acknowledging that the government might play a facilitating role, believe that the process can be best worked out in the marketplace.<sup>164</sup> In assessing which role is most appropriate for the Federal Government, consideration should be given to the questions and answers outlined in table 11-3, which draw from this analysis.

---

<sup>161</sup>For a discussion of the impact of technological change on the ONA process, see Richard Solomon and Loretta Anania, “Paradoxes and Puzzles of Digital Networks, Part I,” *Telecommunications*, January 1987, pp. 26, 28; and Anthony Rutkowski, “Computer IV: Regulating the National Public Information Fabric,” presented at ICC-ISDN ’87, Dallas, Texas, Sept. 16, 1987.

<sup>162</sup>See, for one, Williams, op. cit., footnote 131.

<sup>163</sup>Tom Valovic, “ONA: The Gateway Between Public and Private Networking,” *Telecommunications*, March 1988, p. 31

<sup>164</sup>See for example, Dan Hubbard, “ONA: A BOC perspective,” *Telecommunications*, March 1988, p. 36.

**Table 11-3--Open Network Architecture: Factors Affecting the Choice of Federal Options**

1. Apart from its value to individual stakeholders, of what value is the setting of standards in this area from a societal perspective?	Extremely important insofar as entire regulatory policy is built on the assumption of achieving acceptable ONA standards. Important for industry structure/antitrust implications, as well as for assuring rules of access.
2. What is the cost of waiting for standards to be established in the marketplace or through a voluntary consensus process?	Costs would be great in terms of slowing down decisions relating to the structure of the communication industry. Negative implications for network modernization, as well as for extent of access to information services. In the long run, could have costs in terms of ability of the United States to compete in the global economy.
3. How likely is it that, in the absence of government involvement, de facto or voluntary standards will be adopted in the near term? a. To what extent do vendors share a common interest in developing standards and agree on the appropriate standard? b. To what extent are users eager to standardize? Do they agree on a standard? What leverage do they have vis a vis vendors in the marketplace? In the political arena?	Unlikely, given the complexity of the problem, differences among stakeholders, and jurisdictional issues that need to be resolved. RBOCs are basically agreed on value of standards. However, they differ with respect to some aspects of their approaches. Approaches adopted are a significant determinant of competitive position. Competition among vendors likely to grow with standardization. Users warming up to the standards process after initial skepticism. Unsure of their own needs from the process. Outcomes in terms of competition are highly uncertain. Market power vis a vis vendors more or less balanced, with both requiring cooperation. Political power to stall process.
4. To be effective in promoting standards, what level of government involvement would be required? How far would the Federal Government need to go in the direction of setting standards? What kinds of government involvement might be appropriate in this regard?	Extensive/long term. Need to establish guidelines that reflect public policy goals. Greater technology/R&D support to deal with complexity. Support for broader public policy input into the process Resolution of outstanding jurisdictional issues.
5. How susceptible are standards to technological change? How many possible options or choices of standards are there?	Very susceptible to technological change. Complexity of problem confounded by need for multiple standards.

SOURCE: Office of Technology Assessment, 1989.

**Chapter 12**

**Modernization and  
Technological Development in the  
U.S. Communication Infrastructure**

## CONTENTS

	<i>Page</i>
INTRODUCTION .....	325
THE PROBLEM .....	325
STRATEGIES AND OPTIONS .....	341

### *Boxes*

<i>Box</i>	<i>Page</i>
12-A. Factors Affecting Control of Public and Private Networks .....	336
12-B. Summary of Market and Government Influence .....	347

### *Figures*

<i>Figure</i>	<i>Page</i>
12-1. Comparison of U.S. Exports and Imports of Computer, Business, and Telecommunication Equipment, 1982 and 1987 .....	327
12-2. Projected Growth in Communication Networks, 1988-90 .....	333
12-3. Telephone Company Revenue Lost to Bypass .....	334
12-4. Number of ISDN Users by Industry .....	337
12-5. Congressional Strategies and Options To Address Modernization of the Communication Infrastructure .....	343

### *Tables*

<i>Table</i>	<i>Page</i>
12-1. The Regional Bell Operating Companies' Digital Status: Lines and Switches, June 30, 1988, .....	329
12-2. Top 20 Countries: Comparison of Total Expenditures for Communication, 1987-1988 .....	342
12-3. Top 10 Growth Budgets for Communication, 1987-88 .....	342

# Modernization and Technological Development in the U.S. Communication Infrastructure

## INTRODUCTION

As information comes to play a greater role in all aspects of life, many more demands will be made on the communication infrastructure. As seen in chapter 5, for example, a growing number of large businesses, dissatisfied with the limited capabilities of the public communication infrastructure, have begun to develop their own, more technologically advanced networks. In addition, it is clear from the discussion in part 11 of this report that taking full advantage of new communication technologies in the realms of politics and culture, or for individual development and growth, will require significant advances in the communication infrastructure. As the United States takes its place in the emerging global economy, its communication infrastructure will have to be more and more advanced to compete in meeting communication requirements at the international level.

For the U.S. communication infrastructure to adequately meet and balance all of these communication needs, it needs to keep pace with, and take maximum advantage of, advances in communication and information technologies. And it needs to do so in the most efficient and cost-effective manner. However, there is no real consensus concerning which needs should be met. Although people generally agree on the need for a modern communication infrastructure, they view questions of how much modernization is required—as well as how and by whom it should be accomplished, where in the communication infrastructure and in what time-frame it should take place, and how and by whom it should be paid for—as matters of intense debate.

## THE PROBLEM

Historically, the United States has set the international pace for technological development in the realm of communication and information technologies. As described by one communication scholar:

Regulated monopoly produced exceptional performance. Rapidly advancing technology, arising in part from AT&T's [American Telephone and Telegraph's] stellar research arm, Bell telephone laboratories, caused the real costs and prices of products and services to decline while, simultaneously, service was extended to virtually all the nation's rural communities, where costs were several times as high as in the larger cities. This was accomplished in part by direct federal subsidy through the Rural Electrification Administration, and in part by a system of price regulation that massively cross subsidized customers in high-cost areas. By the time the federal government began to question the desirability of and necessity of monopoly, virtually all households were connected to the network.<sup>1</sup>

However, in the late 1970s technological advances began to outstrip the pace of change within the public shared telecommunication network, leading ultimately to the divestiture of American Telephone and Telegraph (AT&T) and the emergence of a number of competing communication networks and service providers.

Competition has clearly contributed to growth and economic activity in the communication sector. According to a study conducted by the Computer Business Equipment Manufacturers Association (CBEMA), total service and equipment revenues in the U.S. telecommunication industry are likely to rise to \$215.8 billion by 1990, as compared to \$186 billion in 1987 and \$196.6 billion in 1988.<sup>2</sup> Viewed from the perspective of shareholders, it is clear that, in the first 4 years following divestiture, the stock prices of the regional Bell operating companies (RBOCs) increased by more than 100 percent (if dividends are included in the analysis) and the total return on equity has averaged about 25 percent, which puts these companies in the same rank as the top third of the Standards and Poor 500.<sup>3</sup>

Notwithstanding these gains, the OTA analysis identified a number of factors that suggest that, in a global information-based environment, the United

<sup>1</sup>Roger Noll, "Telecommunications Regulation in the 1990s," Center For Economic Policy Research, Stanford University, Stanford, CA, August 1988, p. 2.

<sup>2</sup>CBEMA, "The Information Technology Industry Data Book, 1960-1998," 1989, p. 12.

<sup>3</sup>David Warr, "Management in the Tough 1990s: It'll Be a High Stakes, High Risk Challenge," *Telephony*, Jan. 2, 1989, p. 26.

States may find it increasingly difficult to adequately meet the multiplicity of demands placed on the communication infrastructure. These factors include:

***Factor 1: The extension of competition to the international arena and, with it, an increase in the requirements for technological advancement in the communication infrastructure.***

The ability to keep pace with technological change becomes critical in a competitive environment. The recent history of telecommunication in the United States suggests that, with the introduction of competition, telephone companies are no longer able to time the introduction of new technologies to optimize the life-span of their capital resources. Instead, to retain old customers and capture new markets, they must be the first to adopt new technologies and offer new services.

Just as the introduction of competition in the domestic telecommunication market has increased the requirements for technological advancement in the U.S. domestic communication infrastructure, so, too, has the extension of competition to the international arena. In recognition of this growing need to be on the technological cutting edge, the European Community is pressing ahead to be first in the development of broadband integrated services digital network (ISDN) technology.<sup>4</sup> Thus, in a global economy, U.S. performance must compare favorably not only with its own past performance, but also with the performance of those countries that are its primary competitors.

Recent trade figures are not reassuring in this regard. They suggest that the United States is finding it increasingly difficult to retain its world technological leadership.<sup>5</sup> The declining performance in the area of communication and information technologies is particularly alarming because the United

States has traditionally been a world leader in this area. As noted in figure 12-1, U.S. exports of computer, business, and telecommunication equipment decreased from 32.0 percent of the world total in 1982 to 26.5 percent in 1987, while at the same time U.S. imports of these products increased from 15.6 percent of the world total to 27.2 percent.<sup>6</sup>

The economic stakes in this sector are likely to be even higher in the future, given the growing importance of communication and information products and services as a factor in world trade. A recent study by Booz, Allen & Hamilton Inc., predicts, for example, that the world market for moving and managing information will grow 43 percent by 1991, from \$390 billion in 1987 to a total of \$560 billion.<sup>7</sup> The competition for this market is becoming increasingly intense, prompting many in the United States to view competitiveness in telecommunication trade as a priority issue. For those who do, it is essential to move quickly to modernize the communication infrastructure. As two observers have described the present international situation:

As competition intensifies the stakes will increase rapidly. Winners will be amply rewarded and losers will be devastated. The big players are laying their wagers right now for a game in which coming in second means coming in last.<sup>8</sup>

***Factor 2: The high capital costs of modernization and uncertainties with respect to how these capital requirements will be met.***

Success in modernizing the U.S. communication infrastructure will depend, in part, on the Nation's ability to raise the capital required to develop and deploy new communication and information technologies. At present, it is difficult to determine where the United States stands in this regard. How much capital will be required will depend not only on what is entailed in modernization, but also on the

<sup>4</sup>See, for a discussion, *Establishing Advanced Communications in Europe*, IBC Strategic Audit, 1988, Chateau St. Anne, February 1989.

<sup>5</sup>As noted in a report by the Congressional Research Service: "The U.S. deficit in the balance of trade increased from \$36.2 billion in 1980 to approximately \$170 billion in 1986. . . . Until recently, the strength of U.S. advanced technology exports helped to compensate for declining trade in other manufactured goods. However, according to a report issued by the Joint Economic Committee, since 1982 U.S. advanced technology exports have not been able to keep manufactured trade out of a deficit position. The trade surpluses in these products began to decline and in 1986 ran a deficit." Wendy H. Schacht, Library of Congress, Congressional Research Service, "Trade, Technology, and Competitiveness," Issue Brief 87053, updated Apr. 14, 1988, p. 2.

<sup>6</sup>*The Global Position of the United States in Computer Equipment, Business Equipment, and Telecommunication Equipment Markets*, A Global Market Analysis Project performed in conjunction with CBEMA Industry Marketing Statistics Committee, October 1987, p. 9.

<sup>7</sup>"A Scramble for Global Networks: Companies Are Spending Big On Worldwide Communication Systems," *Business Week*, Mar. 21, 1988, p. 141.

<sup>8</sup>Larry Lannon and Czatdana Inan, "International Telecom Spending on the Rise," *Telephony*, Feb. 22, 1988, p. 36.



**Figure 12-1-Comparison of U.S. Exports and Imports of Computer, Business, and Telecommunication Equipment, 1982 and 1987**

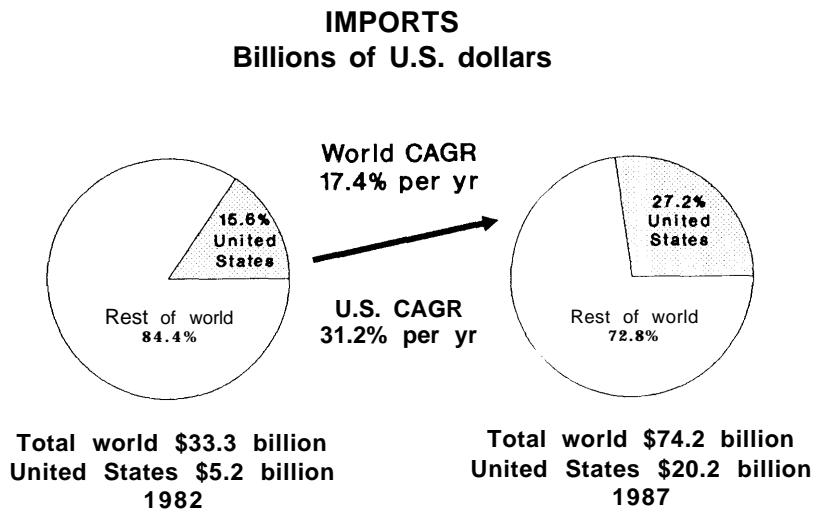
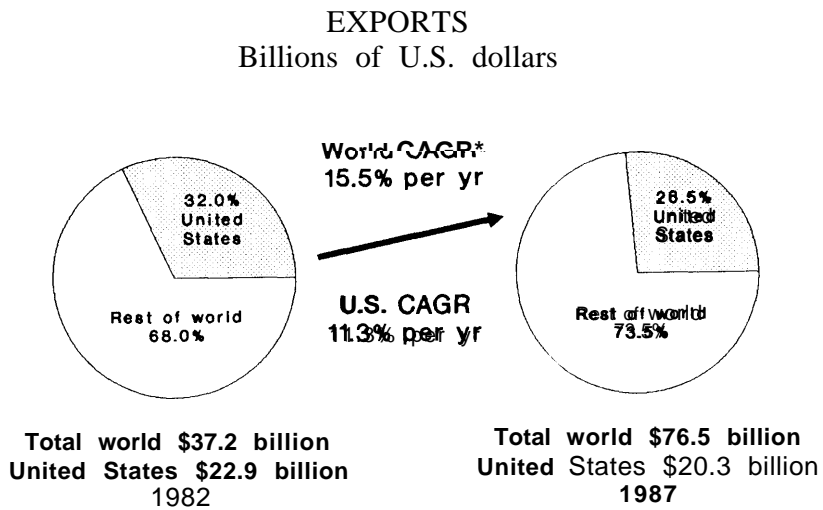

● CAGR = Compound Average Growth Rate

timeframe in which modernization is assumed to take place. For example, the capital costs of gradually developing narrowband ISDN services in response to market demand, and of moving in an evolutionary fashion to develop broadband ISDN, will be considerably less than those entailed in moving quickly and uniformly to deploy an integrated broadband network.<sup>9</sup>

One measure for assessing how far the United States needs to go in modernizing the communication infrastructure is to look at how equipped the communication network is, at present, to provide advanced communication services, Table 12-1, which depicts the deployment of equipped lines and digital switches, gives one rough estimation.

Another way to measure the extent of modernization is to consider U.S. progress in implementing the intelligent network. The intelligent network makes use of the technological advancement and convergence of telecommunication and computer systems, and especially the emergence of stored program control, digital telephone switching, and fast common-channel signaling systems, such as the Consultative Committee for International Telephone and Telegraph's (CCITT's) No. 7.<sup>10</sup> The research and development of this intelligent network architecture is being conducted at Bell Communications Research (Bellcore), with the assistance of interested vendors, as part of a phased-in process that will ultimately lead to the Advanced Intelligent Network. According to Bellcore, major technology releases—envisioning sophisticated intelligent network products—are scheduled for 1993 and 1995. The long-term network architecture is intended for completion around 1998.<sup>11</sup> Among the services that are pres-

ently available (or likely to be available in the near future) through the intelligent network are advanced 8(K) service, 911 public emergency service, automatic calling card, and televoting.

Even if there were agreement on what is entailed in modernization, and where the U.S. communication system stands with respect to it, it would be difficult to estimate the capital requirements. Historical data on the actual costs of providing communication services are very limited because of the problems entailed in identifying costs under the predivestiture telephone system. As Anthony Oettinger has described the problem:

From an angle whence the very definitions of products and of services along with the definitions of their costs and of their prices all look discretionary, such questions as "what are the true costs?" and "what are the associated cost-based prices?" amount to hunting the unicorn.<sup>12</sup>

Moreover, as Bruce Egan and Lester Taylor have pointed out:

The current decision to invest in digital fiber technology is unprecedented relative to decisions of the past, since it represents a major transformation of the network in a competitive environment. Every other major investment decision was made in a monopoly environment and the investment decision was therefore almost completely dominated by considerations of service quality, cost savings, and regulatory assurance of capital recovery.<sup>13</sup>

Nor is it easy to predict future costs, given rapid technological change and numerous uncertainties about the nature of the communication infrastructure. It is only recently, for example, that tariffs have

<sup>9</sup>For efforts to examine costs, see Bruce L. Egan and Lester D. Taylor, "Capital Budgeting for Technology Adoption in Telecommunications: The Case of Fiber," prepared for presentation at Bellcore/Bell Canada Industry Forum, "Telecommunications Costing in a Dynamic Environment," San Diego, CA, Apr. 5-7, 1989. See also the discussions on cost in William Lehr, "ISDN: An Economist's Primer for a New Telecommunications Technology," Department of Economics, Stanford University Technology and Progress Seminar, Feb. 14, 1989; and Robert Pepper, "Through the Looking Glass: Integrated Broadband Networks, Regulatory Policies, and Institutional Change," Office of Plans and Policy, Federal Communications Commission, Washington, DC, November 1988.

<sup>10</sup>By increasing network intelligence, network decisionmaking can be distributed outside of switching centers. This distributed kind of architecture is extremely flexible, allowing for much greater ease in introducing new services as well as for virtual private networks, and hence much greater user control. For descriptions and discussions, see Denis Gilhooly, "Towards the Intelligent Network," *Telecommunications*, December 1987, pp. 43-45, 48; John O. Boese and Richard B. Robrock, "Service Control Point: The Brains Behind the Intelligent Network," *Bellcore Exchange*, November-December 1987, pp. 13-17; Allen Adams and John Wade, "Looking Ahead to the Next Generation," *Telephony*, May 23, 1988, pp. 157-159; Art Beaty, Jr., "The Evolution to Intelligent Networks," *Telecommunications*, February 1989, pp. 29-36; and Paul Bloom and Patrick Miller, "Intelligent Network/2," *Telecommunications*, February 1987, pp. 57-65.

<sup>11</sup>"Perspective on the Advanced Intelligent Network," Bellcore Press Release, Mar. 27, 1989.

<sup>12</sup>Anthony G. Oettinger, "The Formula is Everything Costing and Pricing in the Telecommunication Industry," Center for Information Policy Research, Harvard University, Cambridge, MA, October 1988, p. 1.

<sup>13</sup>Egan and Taylor, *op. cit.*, footnote 9, p. 1.

**Table 12-1—The Regional Bell Operating Companies' Digital Status: Lines and Switches, June 30,1988**

	Equipped lines <sup>a</sup>	Percent digital	Local switches	Percent digital
Nynex .....	16,392,000	38	1,292	56
Bell Atlantic .....	16,919,000	35	1,585	39
BellSouth .....	17,515,000	34	1,323	36
Ameritech .....	17,594,000	26	1,262	36
Pacific Telesis .....	13,900,000	23	744	33
us west .....	13,456,000	22	1,321	21
Southwestern Bell .....	13,017,000	18	1,706	20
Total .....	108,793,000		9,233	

● Total central office line capacity (access lines average 85 percent of equipped lines).

SOURCE: Reprinted with permission from *Telephony*, Jan. 9, 1989.

begun to be set for the first ISDN offerings.<sup>14</sup> Not surprisingly, therefore, the range of estimates is very broad. Looking only at the cost of deploying fiber technology to the local telephone loop, for example, estimates range from as low as \$1,500 per subscriber to as high as about \$20,000 per network subscriber. Considering these costs together, the total cost of a fiber network might be anywhere between \$150 billion and \$2 trillion.<sup>15</sup>

Estimates, of course, will depend on the indicators used. One analysis looks at the \$5 million to \$15 million per switch that would be required to replace approximately 12,000 central office switches with the latest digital switch.<sup>16</sup> Another uses the figure of \$1,500 per subscriber to estimate the total network cost of installing fiber as \$100 billion.<sup>17</sup> Another analysis, which looks only at the incremental cost to the local exchange companies of upgrading their networks for the provision of narrowband ISDN, concludes that the amount of money required for modernization will be approximately \$17.6 billion.<sup>18</sup>

Another major factor affecting modernization costs is the rapid pace of technological change, and hence the likelihood that newly deployed technologies may have only a short lifespan. For example,

developments in broadband ISDN technologies may soon make narrowband ISDN obsolete, even though the deployment of narrowband technologies has only just begun.<sup>19</sup> In fact, the cost of recently sunk investment may be high enough to significantly retard modernization.<sup>20</sup> It has been suggested, for example, that ISDN's slow rate of adoption has been due in part to the fact that so many new private branch exchanges (PBXs) have been installed over the past 5 years. Against this problem of obsolescence, however, one must weigh the fact that new technologies decline in cost as they mature. For example, there have recently been such declines in the costs of PBXs and T1 multiplexers.<sup>21</sup> And, of course, the extent to which technological change serves to retard modernization will depend, in part, on allowable depreciation rates.

The problem of determining whether the United States will be able to provide sufficient capital to modernize the Nation's communication infrastructure is not merely one of estimating the costs involved. It is also necessary to ascertain whether such a large amount of capital will be forthcoming, and, if so, from whom and through what processes. In the United States, there has been very little

<sup>14</sup> Illinois Bell First With ISDN," *The ESC Monthly Report*, April 1988, vol. 3, p. 13. Recently, AT&T has also released tariffs for some ISDN services.

<sup>15</sup> Egan and Taylor, *Op. Cit.*, footnote 9, p. 3.

<sup>16</sup> Lehr, *op. cit.*, footnote 9, p. 57.

<sup>17</sup> Pepper, *op. cit.*, footnote 9, p. 10.

<sup>18</sup> Lehr, *op. cit.*, footnote 9, p. 56. This estimate is based on the \$2 billion that Pacbell plans to spend to complete its digital switch upgrade program and the over \$200 million that will be required to deploy signaling system 7 (SS7). To get the \$17.6 billion figure, Lehr multiplies this total cost by seven regional holding companies plus GTE. He notes, moreover, that additional investments would need to be made by the interexchange carriers.

<sup>19</sup> See Loretta Anania and Richard J. Solomon, "The Beut, and the Beast: Virtual Networking in B-ISDN," *Telecommunications*, September 1987, pp. 33-34.

<sup>20</sup> Clare Lee, "ISDN—User Doubt and Tariff Issues," *Telecommunications*, April 1988, p. 57.

<sup>21</sup> For example, see Neil Watson, "T1 Vendors Play 'Price is Right'," *CommunicationsWeek*, Dec. 26, 1988, pp. 1, 18.

discussion of this issue.<sup>22</sup> As Anthony Rutkowski has described the situation in reference to the open network architecture (ONA) process:

The costs of openly providing the necessary network interfaces and BSEs [basic service elements], especially on a nation-wide scale and with older equipment, can be enormous. No guidelines presently exist as to how to separate the necessary from the frivolous, nor to decide what is funded out of the existing regulated rate base versus what is derived from other sources of revenue, nor how to separate those functionalities which are employed for interstate vs. intrastate service.<sup>23</sup>

The general operating assumption appears to be that where there is a demand for modernization there will be profit-making opportunities, and hence sufficient incentive to generate the necessary capital resources. However, notwithstanding impressive economic growth in the communication sector and the emergence of a vast array of new providers of communication goods and services, there are a number of reasons why policymakers might be concerned about the future prospects of capital accumulation for infrastructure development. Among these are:

**Reason 1: The sheer magnitude of the costs involved.**

Although there has been no detailed analysis of the costs of developing and deploying a fully modernized U.S. communication infrastructure, most people agree, on the basis of informal estimates, that these costs will be extremely high. Such estimates are corroborated by those of foreign governments. The Government of the Federal Republic of Germany, for example, assumes that the

cost of converting their telecommunication system into an ISDN will be approximately \$40 billion over the next 30 years.<sup>24</sup>

The increasing cost of R&D also suggests an increase in the costs of modernizing and keeping the U.S. communication infrastructure up to date. According to the National Science Foundation (NSF), for example:

Over the next decade, the U.S. will have to more than double its annual expenditures on academic R&D merely to maintain its base level. One person-year of senior R&D effort will increase from \$155,000 to \$180,000-\$205,000 by 1996 [in constant dollars].<sup>25</sup>

Increased R&D costs can have a major impact on the costs of modernizing the communication infrastructure because communication technology is so R&D-intensive.<sup>26</sup> As Karl Frensch, executive director of Siemen's public switching division in Munich, has pointed out with respect to the R&D required to develop a modern switching system:

Developing a large public switching system requires an immense amount of R&D, let's say on the order of \$2 billion for the whole system over its lifetime of about ten years . . . You can only make this investment if you have 10% to 15% of the world market.<sup>27</sup>

The cost of capital can also be expected to increase, insofar as it is unlikely that internally generated funds will be sufficient to meet future needs, and much of the cost will have to be financed through borrowing.<sup>28</sup> The cost of such funds maybe quite high, given the risks entailed in investing in an

<sup>22</sup>One of the few discussions of this issue is in Egan and Taylor, op. cit., footnote 9. According to their analysis: "The LECs [local exchange carriers] face a large capital shortfall in their efforts to aggressively pursue widespread deployment of fiber to homes and businesses. Under current market conditions and fiber cost levels, it appears that the LECs will require about \$100 billion in new revenues beyond the internal cash flows over the construction horizon just to cover the costs of fiber for plain old telephone service (POTS) functionally. Advanced fiber systems providing for a wide range of new customer services would cost even more."

<sup>23</sup>Anthony M. Rutkowski, testimony before the House Committee on Energy and Commerce, Subcommittee on Telecommunications and Finance, July 30, 1987.

<sup>24</sup>Rolf T. Wigand, "Integrated Services Digital Networks: Concepts, policies, and Emerging Issues," *Journal of Communication*, vol. 38, No. 1, Winter 1988, p. 36.

<sup>25</sup>National Science Foundation, "Future Costs of Research The Next Decade for Academe," Report PRA-87 by NSF's Division of policy Research and Analysis.

<sup>26</sup>As noted by Kenneth Flamm: "Only the aircraft and missile industry, with significant support from the Defense Department, spends a greater share (14 percent) of its sales on R&D." Kenneth Flamm, "Technological Advance and Costs: Computers Versus Communications," in Robert Crandall and Kenneth Flamm (eds.), *Changing the Rules: Technological Change, International Competition, and Regulation in Communications* (Washington, DC: The Brookings Institution, 1989), pp. 13-14 (footnote 2).

<sup>27</sup>As cited in Jefferson Grigsby, "Global Report: Telecommunications," *Financial World*, Apr. 18, 1989, p. 34.

<sup>28</sup>See Egan and Taylor, op. cit., footnote 9.

economic sector characterized by rapid technological advancement.<sup>29</sup>

## **Reason 2: The potential problems entailed in generating funds for research, development and deployment.**

Capital for research, development, and the deployment of new communication and information technologies is derived from government funding, the reinvestment of profits, and borrowing in financial markets. Looking at these basic sources, it appears that obtaining capital for modernizing the U.S. communication infrastructure may be somewhat problematic in the future.

One factor suggesting such an outcome is the reduced levels of government funding in R&D, especially in relationship to the commercial applications of new technologies. For example, according to a report recently released by Battelle Memorial Institute:

After adjusting for projected R&D inflation, real outlays will increase about 2% next year, down markedly from the 10-year average of 3.518% . . . Defense Department research spending will decline slightly next year because of pressures to reduce the federal deficit. Nonetheless, the Defense Department will account for 28% of total R&D expenditures next year, and will get 60% of federal research funds.<sup>30</sup>

Regulatory policies may also discourage investment in modernization. For example, some have suggested that rate-of-return regulation, by capping the potential payoffs at levels too low to offset the risks of failure, discourage private, equity investment in the public telecommunication network.<sup>31</sup>

Others have argued that present methods of calculating depreciation rates provide inadequate incentives to attract investment for innovation.<sup>32</sup> Still others say that the uncertainty concerning the rules that govern communication companies' activities and operations is, in itself, enough to discourage investors.<sup>33</sup> As one market analyst has noted:

Since the return on investment is not immediate and transition uncertainties loom large, telecommunication companies tend to be valued at some discount to their actual revenues. Over the past 4 years telecommunications has not been an attractive area to achieve investment return.<sup>34</sup>

An additional factor inhibiting investment might be increased political contention at the local level concerning the need for modernization and the manner in which it should be financed. In the face of growing pressure for modernization, State regulators, for example, want greater assurance that the capital required for modernizing the network is not paid for by ratepayers who will not benefit from new services.<sup>35</sup> Many States now require that decisions to construct new plant be based on an economic analysis that can demonstrate that ratepayers' benefits exceed the cost of development.<sup>36</sup> Such decisions can be highly contentious. For, as Wheatley, Selwyn, and Kravtin have pointed out:

. . . an assessment of specific capital decisions is rarely straightforward. The introduction of new technologies often brings with it the availability of new services along with cost efficiencies in the provision of existing services. There is seldom agreement among all parties as to the relative merits of the new services for different classes of customers

<sup>29</sup>For a discussion, see Wenner, *op. cit.*, footnote 3, pp. 24-38. See also discussion on raising capital that directly follows.

<sup>30</sup>As cited in, "Group Forecasts 3.4% Rise to \$129.2 Billion Level After a 6% Jump in 1988," *The Wall Street Journal*, Dec. 21, 1988, Technology Section, p. 1. As Professor Lewis Branscomb has noted, the strong emphasis on military applications has drained critical resources from the commercial sector. Testifying before the House Committee on Science, Space, and Technology, Technology Policy Task Force, he pointed out, for example, that: "While recent federal budgets have permitted growth in some agency research programs—notably the NSF—the overall federal pattern is weak, primarily because of the failure of the Department of Defense to build its fundamental research base at the same time it extracts from the existing base with massive increases in applied research and development. Just as each corporation funds its share of industrial research, so too federal agencies must each re-invest in the knowledge base their program draws from." Testimony, June 25, 1987.

<sup>31</sup>See, for one discussion, Loretta Anania and Richard Jay Solomon, "Capital Formation and Broadband Planning: Can We Get There From Here?" *Telecommunications*, November 1987, pp. 26, 28. See also discussion in Egan and Taylor, *op. cit.*, footnote 9.

<sup>32</sup>See, for instance, T. Nouisaine, S. Brant, and J. Murray. "Give Depreciation the Appreciation It Deserves," *Telephony*, July 18, 1988, pp. 52-58; and Larry F. Darby, "The ABCS of Telecommunication Depreciation . . . And Why They Matter," *Telematics*, vol. 4, No. 1, January 1987, pp. 3-9.

<sup>33</sup>See, for a discussion, "Progress On Hold? Telecommunication Needs Less Regulation, More Competition," *Barron's*, Oct. 5, 1987.

<sup>34</sup>Jon W. Bayless, "Telecommunications: A Venture Capital perspective," *Telecommunications*, January 1989, p. 25.

<sup>35</sup>For one discussion, see Leslie Albin, "Digital Tomorrowland: Who Will pay for the Gold Plated Network," *Telematics*, vol. 3, No. 10, October 1986. See also, Nancy J. Wheatley, Lee L. Selwyn, and Patricia D. Kravtin, "Telecommunications Modernization: Who Pays?" prepared for the National Regulatory Research Institute by Economics and Technology, Inc., September 1988.

<sup>36</sup>*Ibid.*, p. 10.

or as to the benefits of the operating efficiencies that should be attributed to existing services.<sup>37</sup>

Raising capital for modernization may also become more difficult, given increased competition for funds among high technology firms (especially in the venture capital market) to finance new companies selling advanced products. There is also a growing disinclination on the part of financiers to fund communication or information-related technologies. For example, in a recent survey of the largest venture capital firms, it was found that of the 209 firms that responded, 70 percent planned to invest from \$1 million to \$10 million in high technology companies in 1988. Rating their preferences, they put software, computers, and communication second, seventh, and eighth on their lists. Only three firms expected to invest in fiber optics, and only one was interested in network management and/or networking systems.<sup>38</sup>

### **Reason 3: The shift of resources to privately owned communication systems.**

As emphasized in chapter 5, the need for specialized, upgraded, and technologically advanced communication systems is particularly felt in the business community, where communication increasingly provides the leverage for competitive advantage. Dissatisfied with the technical limitations, lack of corporate control over, and high costs of publicly provided telecommunication services, many corporations have begun to establish their own private and/or competing systems. By 1986, more than one-third of all U.S. spending on capital facilities for telecommunication was accounted for by individuals and firms apart from communication common carriers.<sup>39</sup> And in 1987, sales of transmission lines

and equipment for private networks were estimated to be \$14 billion, an increase of 6 percent from 1986.<sup>40</sup> Most recently, expenditures on private networks have been estimated to be in the range of \$16 billion.<sup>41</sup>

The development of these private networks has been facilitated by the emergence and availability of new technologies that allow users to purchase communication products and services in an unbundled fashion. They have also been encouraged by regulatory policies, such as open network architecture (ONA), that call for increased competition and the unbundling of network services. Commenting on the effect of these developments, one observer noted, for example, that:

[After divestiture, the] transition from a monopolistic to a competitive environment, coupled with the availability of affordable alternative transmission media such as optical fiber, DTS microwave, and small aperture satellite communication terminals, witnessed mounting "bypass" activity. Protests about lost revenues were heard from the carriers. Competition would now come from two directions: private networks and alternative service providers.<sup>42</sup>

One way of looking at the extent to which communication systems may become privatized is to examine the rapid development and deployment of T1 technology in the corporate business environment. (See figure 12-2 for projected growth in communication networks.) Providing for the integrated transmission of voice, data, and image traffic, voice compression, the flexible use of bandwidth, as well as alternate routing, T1 offers users considerable cost savings and much greater network con-

<sup>37</sup>Ibid., p. i. As they note: "Regulatory commissions will be required to assess modernizing projects involving facilities that are used to furnish both regulated and unregulated services. A mismatch of costs and benefits from these projects can occur if costs and revenues are not consistently allocated between the ratepayers and the shareholders. A mismatch can also occur if there is a change in the regulatory status of one of the services furnished using upgraded plant subsequent to its acquisition. Finally, the cost of capital of a regulated firm may change as the firm takes on increasingly risky activities. Each of these potential cost/benefit matches arises because the telecommunications utility is no longer providing only regulated services. . . the policy challenge is to devise a method to reduce or eliminate these potentially significant cost/benefit mismatches." Ibid., p. ii.

<sup>38</sup>Speech by Henry J. Mayer, President, Mayer Frank & Co., Inc., as reported in *The ESC Monthly Report*, vol. 3, April 1988 Edition, pp. 4-6; see also Bayless, op. cit., footnote 34.

<sup>39</sup>Robert W. Crandall, "Fragmentation of the Telephone Network," *The Markle Foundation, New Directions in Telecommunications Policy*, vol. 1, *Regulatory Policy: Telephony and Mass Media* (Durham, NC: Duke University Press, June 1989), p. 49.

<sup>40</sup>*Business Week*, op. cit., footnote 7, p. 140.

<sup>41</sup>William H. Davidson, "Trends in Telecommunications Networks: Regulatory Issues and the Outlook for the U.S. Information Economy," University of Southern California, Los Angeles, CA, April 1988, p. 44. A recent study by Coopers & Lybrand puts worldwide sales of equipment and transmission facilities for private networks at \$52 billion in 1988, and projects that such sales will reach \$147 billion by 1992. Coopers & Lybrand, "The Impact of Emerging Intelligent Networks in New York State," February 1989, p. 2.

<sup>42</sup>Victoria A. Brown, "T1 Networking and open Systems," *Telecommunications*, January 1989, p. 56.

<sup>43</sup>T1 circuits operate at 1.544 megabits per second and consist of 64 kilobits per second voice or data, plus a framing bit. For a description, see *ibid.*

trol.<sup>43</sup> Hence, it is appealing to the large-volume business user.

Although T1 services were originally provided by AT&T in the early 1960s, vendors of customer premises equipment (CPE)—responding to the growth in data traffic as well as to the entrepreneurial opportunities presented by the divestiture of AT&T—began in the early 1980s to provide high performance point-to-point T1 multiplexer specialized for business use.<sup>44</sup> The corporate demand for T1 services grew rapidly, at an annual rate averaging from 30 to 40 percent.<sup>45</sup> The growth of this market should continue steadily into the future. In fact, given an ever-increasing demand for data communication (estimated to have grown by 40 percent since 1970, and predicted to account for 40 percent of all communication services by the early 1990s), some large companies are now beginning to employ T3 circuits, which operate at 44.736 megabits per second (Mbps).<sup>46</sup> Moreover, because it is now becoming possible for vendors to offer fractional T1 services, smaller businesses may also enter the market, finding it economically more feasible to develop their own telecommunication systems.<sup>47</sup> Also driving the future demand for T1 and T3 services will be applications such as videoconferencing, computer-aided design/manufacturing (CAD/CAM), bit-mapped work stations, image transfer, high-speed local area network (LAN) bridges, and mainframe-to-mainframe links, which all exhibit appetites for bandwidth in the megabit range.<sup>48</sup>

How the use of such technologies in private networks will affect the public communication infrastructure is a matter of considerable debate, focusing heavily on the issue of bypass. Defined in a variety of ways, bypass generally refers to the act

Figure 12-2-Projected Growth in Communication Networks, 1988-90

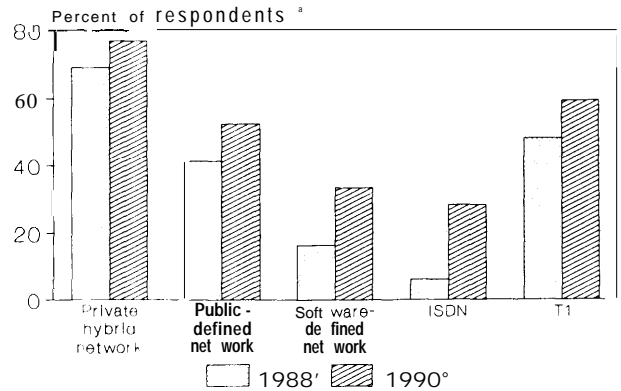

\* Base of 100 \$100 million-plus companies surveyed

SOURCE: Copyright 1988 by CW Publishing Inc., Framingham, MA 01701. Reprinted from *Computerworld*.

of avoiding the local exchange carrier (LEC) in transmitting messages. The term, however, can refer specifically to the circumvention of LECs' facilities (known as facilities bypass) or to the circumvention of various services that the exchange carrier provides (known as service bypass). Moreover, the notion of bypass can be differentiated on the basis of whether it allows for the most efficient allocation and use of resources (known as economic bypass), or whether it is inefficient, resulting from distortions in price (known as uneconomic bypass).

How one measures the impact of bypass on the public communication infrastructure will depend in large measure on the type of bypass. For example, the extent of damage to the LEC due to bypass may be much less if it is only a number of services, and not the entire physical facility, that are circumvented. Or, in the case of economic bypass, it can be

<sup>44</sup>Ibid. See also Stephen Fleming, "The Evolution of T3 Networking," *Telecommunications*, December 1988, pp. 16-20. As the author notes: "By the first half of the 1980s, three major events occurred to change the usage pattern of digital transmission links. First, telephone operating companies began converting major portions of their networks to digital transmission, making T1 pipes more accessible. Second, divestiture opened up competition in the telecommunications marketplace so that the time-to-market of new products and services became much shorter. Third, the continuing revolution in end-user computing power meant that a corporate telecommunications manager now had to administer complex data networks in addition to existing voice networks. Entrepreneurial companies such as Network Equipment Technologies, Cohesive, & Infotron, began adapting public network T1 technology for sophisticated private network requirements. T1 usage by end users began skyrocketing." p. 16.

<sup>45</sup>Tom Valovic, "Assessing the Complexities of the T1 Marketplace," *Telecommunications*, December 1988, p. 16; see also M. Gawdun, "Future Directions in Transmission," *Telecommunications*, December 1987, pp. 48-49.

<sup>46</sup>A recent study by the Yankee Group reports that there are now about 25 corporations involved in T3 networking, including General Motors, Monsanto, McDonnell-Douglas, and American Airlines, Tom Valovic, "T1, T3, and the Never-Ending Bandwidth Argument," *Telecommunications*, December 1988, p. 6.

<sup>47</sup>For a discussion, see Neil Watson, "Mux Market Moves," *CommunicationsWeek*, Dec 26, 1988, p. 17; Elizabeth Horwitt, "Data Seen Increasing On T1 Links," *Computerworld*, Jan. 9, 1989, p. 27; and Nathan J. Muller and David Hoist, "Customers and Carriers Can Benefit From Fractional T1 Services," *Telephony*, December 1988, pp. 33-37.

<sup>48</sup>Fleming, *op. cit.*, footnote 44, p. 19.

argued that, while LECs may suffer losses, society as a whole is better off, since resources are allocated most efficiently.<sup>49</sup>

Given these alternative ways of ascertaining bypass, it is not surprising that stakeholders strongly disagree about the actual extent to which bypass of the public telephone network has taken place and the impact it is having.<sup>50</sup> Telephone companies have claimed major losses. In their most recent assessment to the Federal Communications Commission (FCC), for example, the RBOCs claimed that they had lost \$3.7 billion to bypass, as can be seen in figure 12-3.<sup>51</sup> On the other hand, telephone company competitors, together with local regulators and many consumer groups, have tended to minimize the damage due to bypass. As noted in a report prepared for the National Association of State Utility Consumer Advocates, many of these groups challenge FCC's conclusions about bypass on the grounds that they overemphasize price as the motivation for bypass and fail to consider bypass in the context of RBOCs overall growth. According to this perspective, FCC's analysis:

... largely ignore[s] the critical role of services considerations in the bypass decision. Bypass surveys performed by user groups have generally concluded that non price, service factors, including the unavailability of a service from the local telephone company, are more powerful bypass motivators than price.

The case has not been made that bypass is now, or will be, of such magnitude as to have an impact on the revenues of the local operating companies. There is no evidence that companies currently employing bypass alternatives have generally reduced their uses of the local telephone company switched services.<sup>52</sup>

Measuring bypass is likely to be even more difficult in the future, given rapid technological advancement. For example, confusion will arise when greater intelligence is built into the network,

**Figure 12-3-Telephone Company Revenue Lost to Bypass**

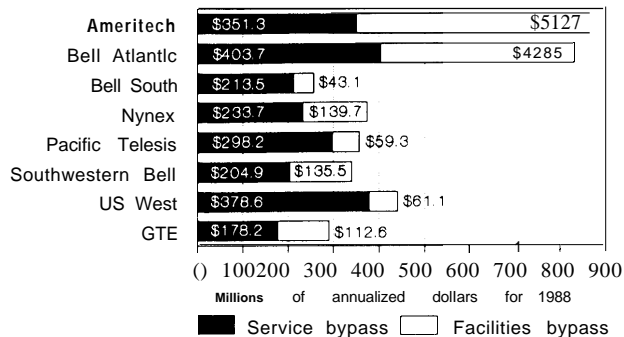

SOURCE Copyright 1988 by CMP Publications, Inc., 600 Community Drive, Manhasset, NY 11030. Reprinted from *CommunicationsWeek* with permission.

insofar as it becomes more and more difficult to distinguish between what constitutes facilities and what constitutes service. As Solomon and Anania have pointed out:

These problems arise because the digital switch will be thoroughly integrated with digital transmission and with customer premise digital terminal equipment (voice, data, or hybrid). The seamless, digital integration creates paradoxes for regulators, service providers and customers. Since multiple computers will be accessing each other at the control levels of their central processors, how will each switch (computer) know the difference between lineside traffic and trunkside traffic? How will the computer switches handle contention for resources? How will each switch know what is public and what is private?<sup>53</sup>

Moreover, the problem of distinguishing between economic and uneconomic bypass will be compounded by the difficulties entailed in sorting out costs and prices in an integrated broadband network (IBN) environment. As Robert Pepper has noted:

The inherent arbitrariness of old fashioned rate base rate-of-return ratemaking, where tariffs are cost

<sup>49</sup>For a discussion of these distinctions, see U.S. Congress, General Accounting Office, "Telephone Communications: Bypass of the Local Telephone Companies," GAO/RCED 86-88, August 1986.

<sup>50</sup>Government studies on bypass have included: "Bypass of the Public Switched Network." Common Carrier Bureau, Federal Communications Commission, Dec. 19, 1984; U.S. General Accounting office, op. cit., footnote 49; Gerald Brock, "Bypass of the Local Exchange: A Quantitative Assessment," OPP Working Paper #12, Federal Communications Commission, September 1984; Racster, Wong and Goldman, "The Bypass Issue: An Emerging Form of Competition in the Telephone Industry," No. 84-17, The National Regulatory Research Institute, Columbus, OH, December 1984; and Peter W. Huber, "The Geodesic Network: 1987 Report on Competition in the Telephone Industry," prepared for the Department of Justice in accordance with the Court's decision in *US, v. Western Electric Company*, Supp. 131, 194-5.

<sup>51</sup>Monitoring Report prepared by the Staff of the Federal-State Joint Board, CC Docket 80-286, p. 98, table 601. Telephone company bypass is monitored and assessments are made to the FCC on a quarterly basis.

<sup>52</sup>"Bypass and the Subscriber Line Charge," prepared for the National Association of State Utility Consumer Advocates, Bethesda Research Institute, Ltd., Bethesda, MD, June 1987, pp. ii-iii.

<sup>53</sup>Richard J. Solomon and Loretta Anania, "Paradoxes and Puzzles of Digital Networks, Part 1," *Telecommunications*, January 1987, pp. 26-28.



supported by attempting to assign costs to "cost causers," will become even more apparent if such regulation is applied to tomorrow's IBNs. Traditional voice telephony and broadband video transmission are so different that any attempt to price them using the same procedures or measures will likely prove futile.<sup>54</sup>

The extent to which bypass will actually occur in the future will depend on a number of factors, including:

- how quickly the telephone companies can upgrade their networks and develop services that meet the needs of business users,
- the positive and negative experiences that large users have in developing and operating their own private communication systems, and
- the regulatory context that sets the ground rules for the provision of communication services.

Since these factors are, themselves, quite uncertain, the outcome with respect to privatization is very difficult to predict. (See box 12-A for a more detailed itemization of these factors.)

Traditional telephone companies have generally considered the development of broadband intelligent networks (moving in an evolutionary fashion from narrowband ISDN to broadband ISDN) as their

primary strategy for competing to meet the communication needs of business.<sup>55</sup> However, as already noted, the full implementation of these systems is still a long way off. Thus, in the interim, telephone companies are undertaking a number of measures to forestall the migration of large users from their networks. To this end, they have moved to upgrade and enhance traditional Centrex services<sup>56</sup> and to develop hybrid network solutions that combine intelligent customer-premises equipment with telephone company transmission and multiplexing services, allowing customers much greater flexibility and control at reduced costs.<sup>57</sup> To meet the growing demand for data transmission services, for example, RBOCs are now offering CO-LANS, a central-office-based local area network service.<sup>58</sup> These new offerings have proved quite successful, not only in terms of restraining the growth of the customer-premises market,<sup>59</sup> but also in terms of providing the telephone companies and their customers a solid transition path for moving toward and implementing ISDN.<sup>60</sup> To avoid the loss of business customers, the traditional telephone companies have also been more aggressive in their pricing and marketing strategies, offering much greater flexibility in the pricing and packaging of services. In a recent effort to generate interest in ISDN, AT&T, for example,

<sup>54</sup>Pepper, *op. cit.*, footnote 9, p. 46.

<sup>55</sup>As noted by Tom Valovic: "Most especially, ISDN becomes important because it offered a universal scheme whereby significant new functionality for both voice and data (and possibly even higher bandwidth applications such as video) could be offered to corporate customers but controlled and managed via AT&T and the BOCs custody of the public networks. This was reinforced by the realization that unless they moved to create these new levels of both network intelligence and control for their customers, they would lose serious competitive advantages as corporate users plunged ahead with their private networking efforts . . ." Tom Valovic, "Public and Private Networks: Who Will Manage and Control Them?" *Telecommunications*, February 1988, p. 42.

<sup>56</sup>Centrex is the general name for a switched business telecommunication service that is provided from the telephone company central office. An alternative way of achieving switching services is through the purchase of a PBX that is located on the customer's premises and is controlled and maintained by the customer. For a comparison of these two types of service, see John R. Abrahams, "Centrex Versus PBX: The Battle for Features and Functionality," *Telecommunications*, March 1989, pp. 27-28, 31-32.

<sup>57</sup>For discussions of these strategies, see Martin H. Singer, "Hybrid Networks Move to Telecom's Center Stage," *Telephony*, Mar. 6, 1989, pp. 41-51; Bob Vinton, "Bells Eyeing MAN Market," *CommunicationsWeek*, Apr. 10, 1989, pp. 34, 38-39; and Martin Pyykkonen, "Centrex Now, LSDN Later," *Telecommunications*, February 1987, pp. 53, 54, 84.

<sup>58</sup>For a discussion, see Anne-Marie Roussel, "Central Office Stepping Stones," *CommunicationsWeek, CLOSEUP*, June 27, 1988, p. C-6.

<sup>59</sup>Modern digital Centrex service has been gaining market share since it first became available in 1984. With the number of Centrex telephones in the United States growing at about 5 percent per year. However, over 50 percent of all Centrex lines in the United States are still provided from analog central offices. Abrahams, *op. cit.*, footnote 56, pp. 27-28.

<sup>60</sup>As Pyykkonen has noted: "For the local operating Companies there is a trade-off to be made regarding the pace at which ISDN services are introduced versus the degree of graceful upgradability which can be implemented in the central office switch. . . . The commitment that has been made by carriers and equipment vendors to ISDN is sufficient to overcome these obstacles over the long term. The question is, how quickly can the obstacles be overcome while being economically feasible for all parties concerned?" *Op. cit.*, footnote 57, p. 54. For one discussion arguing in favor of an evolutionary strategy, see Ye-Sung Cho, "For ISDN, There's No Need to Dismantle the Network: A Smooth Transition is Possible," *CommunicationsWeek*, May 23, 1988, p. 17. Bellcore recently announced a technological breakthrough in internetworking that will facilitate an evolutionary strategy and thus might boost ISDN use. Currently, to offer ISDN services, LECs may have to invest between \$3 million and \$5 million in a new digital switch for each ISDN central office. However, with Bellcore's new breakthrough, telephone companies can interconnect LAN switches with modern digital switches, and thus protect some of their investment in embedded equipment. See Steven Titch, "Bellcore Breakthrough May Boost ISDN Use," *CommunicationsWeek*, Nov. 7, 1988, p. 1.

<sup>61</sup>Beth Schultz, "AT&T To Let Telcos Offer Users Free ISDN," *CommunicationsWeek*, Mar 20, 1989, p. 2.

### **Box 12-A—Factors Affecting Control of Public and Private Networks**

- . Ongoing convergence of computers and telecommunications
- . Development of ISDN and other intelligent network capabilities
- . Increased use and deployment of T 1 networks in private networks
- . The Be-Your-Own Bell phenomenon whereby companies can sell excess capacity
- . Increasing utilization of central office switches as virtual PBXs
- . BOC initiatives to create more “hands-on-control” for customers
- . Acceptance of telecommunications as a corporate, strategic resource
- . IXC/BOC success and lack of success in traditional data communication/computing markets
- . The success of traditional data communication/computer equipment providers in traditional telecommunication markets
- . ONA and the distribution of network control to “private” service providers

KEY: BOC=Bell operating company; ISDN=Integrated services digital network; IXC=Interexchange Carrier; ONA=Open network architecture; PBX=Private branch exchange

SOURCE: Tom Valovic, “Public and Private Networks: Who Will Manage and Control Them?” *Telecommunications*, February 1988, pp. 42-47.

has agreed to let its telephone customers offer their users free ISDN.<sup>61</sup>

What still needs to be determined, however, is how responsive the business community will be to these telephone company overtures. Today there are more than 50 organizations involved in ISDN trials. (See figure 12-4 for a breakdown based on organizational type.) However, many corporate executives continue to be unaware or quite skeptical about the promises of ISDN, questioning its value in meeting

their needs.<sup>62</sup> As Travers Waltrip, Vice President of Travelers Co., has noted:

In actuality, large corporations have built their own de facto ISDN. The environment . . . is a seamless, integrated data, voice and image all-digital network that has tremendous flexibility. Therefore I do not believe large corporations will benefit (at least initially) from commercial ISDN for intracorporate communications . . . At least through the early 1990s, most large corporations will follow their existing communications strategies.<sup>63</sup>

In addition to functionality, cost will also be a critical factor determining demand for ISDN in the corporate business community. According to a number of surveys, most users want cost savings above all, and thus would be unwilling to pay more for ISDN than they are presently paying for telecommunication services. Those most reluctant to spend a lot of money are businesses that have recently invested in new sophisticated telecommunication and switching systems based on pre-ISDN technologies, a sizable sector of the potential ISDN market by most accounts.<sup>64</sup> What ISDN will cost, however, remains uncertain. Until very recently there was no pricing information available to potential customers. Those who signed up early for ISDN trials did so on the basis of customized contracts, with many of the details kept under wraps.<sup>65</sup>

The time required to modernize the public communication infrastructure is also an important variable determining the future relationship between public and private communication networks; however, its effect can work in two contradictory ways. On the one hand, the longer it takes for ISDN and the intelligent network to be implemented, the greater the investment sunk in private systems. Moreover, the more established communication departments become within large corporations, the less willing

<sup>61</sup>Beth Schultz, “AT&T To Let Telcos Offer Users Free ISDN,” *CommunicationsWeek*, Mar. 20, 1989, P. 2.

<sup>62</sup>As noted by Michael Hurwicz: “Primary Rate ISDN was designed to be used the same way as T1 circuits are currently used to carry multiple data and voice channels between private branch exchanges (PBX) or central office switches and, less frequently, to serve as a single high-speed data channel for applications requiring that kind of throughput. Although no single characteristic of ISDN makes it obviously superior to anything else around, the technology offers a number of incremental improvements over other digital transmission technologies.” Michael Hurwicz, “Even Users Who See Promise Are Still Troubled By Questions,” *Computerworld*, Dec. 12, 1988, p. 69. For additional discussions of user skepticism of ISDN, see “ISDN: Another Version of the Emperor’s New Clothes?” *Data Communications*, December 1986, pp. 45-60; “ISDN on Trial,” *Datamation*, Feb. 1, 1987, pp. 51-56.

@T Travers Waltrip, “ISDN and the Large Corporation,” *Telephony*, May 9, 1988, pp. 40-41.

<sup>64</sup>For example, it is estimated that, over the past 5 years, PBX replacement has taken place in the United States and Europe at a rate of over 60 percent. See Lee, op. cit., footnote 20, p. 57.

<sup>65</sup>See Kathleen Killete, “Controversial Costs: Though Two Tariffs Have Been Filed, Analysts Agree ISDN Pricing Remains Obscure,” *CommunicationsWeek*, CLOSEUP, Sept. 19, 1988, pp. C-8, C-9.

Figure 12-4--Number of ISDN Users by Industry

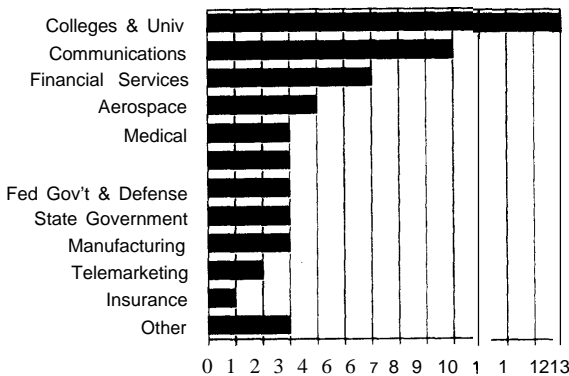

SOURCE: Copyright 1988 by CMP publications, Inc., 600 Community Drive, Manhasset, NY 11030. Reprinted from *CommunicationsWeek* with permission.

they may be to give up such control at some point in the future. As Tom Valovic has pointed out:

Having painfully learned the joys of autonomously operating a network, and in large measure having succeeded in the task, it seems unlikely that network managers will hand control of their network operations back to the comforting but potentially smothering embrace of AT&T and the BOCs [Bell operating companies].<sup>66</sup>

On the other hand, time has also demonstrated some of the hidden costs entailed in developing private networks. Recently, for example, a number of companies, facing cost overruns and a scarcity of manpower and technical expertise, have decided to give up their efforts to develop their own networks and call for bids from telecommunication vendors.<sup>67</sup>

Given these uncertainties, it is difficult to predict how much privatization will take place within the communication infrastructure. However, it is clear

that, to the extent that businesses continue to establish their own private communication networks at their present rate, fewer societal resources will be available to develop and modernize the publicly shared network.<sup>68</sup> Under such circumstances, a spiraling effect might take place, whereby the lack of investment in the public network would lead to greater bypass and unbundling. Moreover, such a two-tiered system might prove to be inefficient, especially to the extent that new technologies, such as fiber optics and common channel signaling could, over the long run, allow for greater flexibility within a single communication network.

### ***Factor 3: The potential inefficiencies that might result from a lack of national coordination and planning.***

The divestiture of AT&T, accompanied by a national policy of deregulation, has led to heightened competition among economic players in the communication infrastructure, as well as to the fragmentation and decentralization of the process by which major communication decisions are made. Some observers see these changes as being highly favorable for the modernization and development of the U.S. communication infrastructure.<sup>69</sup> Pointing to evidence such as AT&T's recent decision to write down \$6.7 billion as part of its modernization effort,<sup>70</sup> they argue that competition has fostered innovation and hastened the deployment of new technologies. For example, in his analysis comparing the rapid rate of innovation in the computer industry with the slow rate in communication industries, Kenneth Flamm makes such a case.<sup>71</sup> And, in fact, as discussed in chapters 3 and 4, it was just such a perspective that served as part of the

<sup>66</sup>Valovic, op. cit., footnote 55, p. 45.

<sup>67</sup>For a discussion, see John Foley, "Merrill Shifts Gears: Solicits Network Bids," *CommunicationsWeek*, Oct. 21, 1988, pp. 1, 55; Kelly Jackson, "Red Ink Downs Net," *CommunicationsWeek*, Nov. 21, 1988, pp. 1, 43; and John Foley, "Problems Force Users to Retrench," *CommunicationsWeek*, Nov. 7, 1988, pp. 1, 60.

<sup>68</sup>For example, it has been estimated that, in 1988, nearly \$17 billion was spent on private networks in the United States, which is more than the total spent by all of the regional Bell holding companies on infrastructure development. Davidson, op. cit., footnote 41.

<sup>69</sup>See Gerald Faulhaber, *Telecommunications in Turmoil* (Cambridge, MA: Ballinger Publishing Company, 1987); and Robert W. Crandall, "Telecommunications Policy in the Reagan Era," *Regulation*, No. 3, 1988, pp. 28-33, for two very positive evaluations of the post-divestiture period. See also, Kenneth Labich, "Was Breaking Up AT&T a Good Idea?" *Fortune*, Jan. 2, 1989, pp. 82-87.

<sup>70</sup>Peter Coy, "Modernization Costs Give AT&T First Annual Loss," *The Washington Post*, Jan. 27, 1989, p. B-1. As noted, "AT&T took a \$6.7 billion pretax charge in the fourth quarter of 1988 to cover costs of accelerating its transition to digital technology. The company is scrapping outdated analog phone equipment and moving, retiring or laying off 16,000 employees."

<sup>71</sup>Flamm, op. cit., footnote 26, pp. 13-61. However, Flamm notes that, paradoxically: "The old market structure might actually have both increased basic research and slowed innovation. And deregulation and increased competition might step up the pace of innovation yet reduce spending on basic research." Ibid., p. 59. Flamm's argument would account for why, as already noted, the T1 multiplexer was developed under the old Bell system, but neither widely deployed nor perfected until after divestiture when, in a competitive environment, start-up high technology firms such as NET began to develop it.

rationale for the divestiture of the Bell System in 1984.<sup>72</sup>

Others, however, bemoan the destructive aspects of competition, pointing to the inefficiencies it might create.<sup>73</sup> They argue, moreover, that cooperation among government and industries, as has been the case in Japan, can lead to the most productive and efficient deployment of new communication technologies.<sup>74</sup> The possible negative impacts of competition on research and development have been of particular concern, even at the time of divestiture.<sup>75</sup> However, to date, the evidence on R&D is still inconclusive.<sup>76</sup> As is noted below, although the funding for research and development at Bell Labs and Bellcore has, in fact, increased since divestiture, it is not clear that these funds are being employed most efficiently, or that a commitment to joint research will survive in the future when the interests of the telephone companies diverge and/or the competition among them becomes more intense.<sup>77</sup>

Others claim that competition will retard the development of a national ISDN network. Instead, it will foster the emergence of separate, and incompatible, islands of technology.<sup>78</sup> As evidence, they cite the difficulties entailed in establishing national standards in a highly fragmented organizational setting—difficulties that were noted and discussed

in chapter 11. They point, moreover, to the problems involved in setting uniform prices for a basic set of nationwide services. They also question whether—under regulatory circumstances in which RBOCs are constrained from providing services beyond their own local access and transport areas (LATAs), and in which there are no guarantees that interexchange carriers will provide services equivalent to those provided by the RBOCs—the United States will ever be able to develop a truly national, communication infrastructure. As Rolf Wigand has pointed out:

It is not too difficult to imagine the immense technical complications and fragmentations encountered by a customer trying to link ISDN services across several widely dispersed locations nationally. One might question if such conditions will then require special hardware and software for protocol conversion purposes, a condition that was by itself one of the key driving forces to develop ISDN in the first place. Have we then come full circle in this development to digitize information and data moving in the national networks?<sup>79</sup>

Whereas the procompetitive strategy is most highly favored among policymakers in the United States, the planned approach is more common in Europe and Japan (with the partial exception of

<sup>72</sup>Kenneth Arrow provides the classic account of the relationship between technological development and regulated monopolies. In his 1962 analysis, he showed that, all other things being equal, monopolies have less incentive to renovate than firms that can gain some monopoly power through technological advancement. See Kenneth J. Arrow, "Economic Welfare and the Allocation of Resources for Invention," National Bureau of Economic Research, Special Conference Series, *The Rate and Direction of Inventive Activity Economic and Social Factors* (Princeton, NJ: Princeton University Press, 1962). For a discussion that covers the recent theoretical literature, see Sanford V. Berg and John Tschirhart, "Technological Change Under Regulation," *Natural Monopoly Regulation Principles and Practice* (New York, NY: Cambridge University Press, 1988), ch. 10.

<sup>73</sup>For a general critique see, for instance, Robert Reich, *Tales of a New America* (New York, NY: Time Books, 1987). For a discussion focusing on communication technology, see John C. McDonald, "Deregulation's Impact on Technology," *IEEE Communications Magazine*, January 1987.

<sup>74</sup>Michael Borrus, "Japanese Telecommunications: Reforms and Trade Implications," *California Management Review*, vol. XXVIII, No. 3, Spring 1988; see also Jill Hartley, "The Japanese Approach to the Development of New Residential Communication Services," in Marjorie Ferguson (ed.), *New Communications Technologies and the Public Interest* (London, England: Sage, 1986) ch 11, and Carla Rapaport, "The World's Most Valuable Company," *Fortune*, Oct. 10, 1988, pp. 92-104.

<sup>75</sup>The problems that competition might create for R&D was already a concern for some at the time of divestiture. See, for example, the testimonies of William Nordhaus (written testimony, in *U.S. v. AT&T*, 1981); and Nathan Rosenberg, "Some Implications of H.R. 5158 for Technological Innovation in the Telecommunication Industry," testimony prepared for the House Committee on Energy and Commerce, Subcommittee on Telecommunications, May 7, 1982.

<sup>76</sup>Berg and Tschirhart, op. cit., footnote 72; see also David C. Mowery, "Assessing the Effects of Divestiture on Bell Telephone Laboratories," *Technovision*, No. 7, 1988, pp. 353-375. There have already been some moves to do more proprietary research. In the past year, both t-JS WEST and Nynex Corp. have set up their own independent research centers.

<sup>77</sup>Some of these problems, for example, have already been evidenced in other sectors

<sup>78</sup>See, for example, Wigand, op. cit., footnote 24. See also Tom Valovic, "ISDN in the United States: An Assessment," *Telecommunications*, December 1987, p. 7. As Valovic points out: "When it comes to ISDN, the timing of divestiture couldn't have been worse. As it turns out, ISDN was just embryonic enough during the years preceding the 'D' world not to have been a major concern for those contemplating how to slice the huge pie that was AT&T into manageable pieces. And yet, in retrospect, it appears that divestiture has had a serious impact on the development of ISDN in the United States and will continue to do so until the extreme fragmentation of our regulatory climate becomes resolved in some meaningful fashion."

<sup>79</sup>Wigand, op. cit., footnote 24, p. 41

Great Britain).<sup>80</sup> These opposing points of view are clearly evident in the strategies that these countries are pursuing to implement ISDN. In the United States, ISDN is being introduced in a segmented fashion and in response to market demand. In Europe and Japan, ISDN implementation will be more technology-driven. Some provision is being made now to meet current demand for digital integrated services, but complete ISDN services will be held back until they can all be introduced uniformly.<sup>81</sup>

With our poor theoretical understanding of the processes of innovation, it is impossible, at present, to determine which of these approaches will prove to be the "best" for modernizing the communication infrastructure. Some of the advantages and disadvantages inherent in each approach can be illustrated by comparing the evolution of the intelligent network in Europe and the United States. The United States, having benefited from a highly competitive, economic environment, has moved much more quickly to develop new commercial products and services for niche markets than have the European countries. The Europeans, having designed their networks from the top down, are moving much faster than the United States to deploy the signaling system 7 (SS7) switches, which are required to distribute and market these new communication and information services.<sup>82</sup>

While acknowledging the untidiness of the U.S. approach, New York Public Service Commissioner, Eli Noam, casts recent U.S. developments in a positive light. As he has described the state of the future communication infrastructure:

The future network is one of great institutional, technical, and legal complexity. It will be an untidy patchwork of dozens or even hundreds of players, serving different geographical regions, customer classes, software levels, and service types, with no neat classification or compartmentalization possible . . . The major characteristic of the open network

environment is substantial lack of central control with no single entity being in charge. . . To leave this system to the vagaries of hundreds of uncoordinated and selfish actors seems to invite disaster. Can it work? Perhaps this is not the right way to frame the question. Can there be a stable alternative in economies that otherwise favor a market mechanism, and that want to stay on the leading edge of applications?<sup>83</sup>

Responding to his own question, Noam answers it in the affirmative. To create an alternative to central coordination and control, however, will require that government establish a system of open networking by structuring the ways in which interconnection is defined, policed, priced, and harmonized. As Noam notes, rules such as these are presently being negotiated and debated at the State and national levels under the heading of ONA. How well the United States telecommunication infrastructure adapts and deals with the chaos and competition of the postdivestiture era may very well depend, therefore, on the outcome of the ONA process.

#### ***Factor 4: The proactive role played by foreign governments in modernizing their communication systems.***

Although a number of governments throughout the world are moving to privatize and/or deregulate sectors of their communication systems, many of them have retained a role for themselves in building and modernizing their communication infrastructures in support of their industrial policies or other national objectives.<sup>84</sup> Inspired by the Nora-Mine report, the Government of France, for example, assumed the leadership in developing and managing Minitel, supplying terminals free to all telephone subscribers, organizing a billing system, and providing basic services. It has also played an aggressive role in planning for and introducing a national ISDN

<sup>80</sup>For one example of this European perspective, see European Parliament, Session Documents, Document a2-0242/88, "Report Drawn Up On Behalf of the Committee on Economic and Monetary Affairs and Industrial Policy on the Need to Overcome the Fragmentation in Telecommunications," Nov. 8, 1988.

<sup>81</sup>For a discussion, see P. Slaa, *ISDN as Design Problem* (Leiden: The Hague, Ruud Philipsen, April 1988).

<sup>82</sup>Peter Purton, "Europe's Intelligent Networks: A Glimmering Start," *Telephony*, Aug 22, 1988, pp. 32, 36, 37. Just as some of the problems of a market-driven approach are coming to light in the United States, so the problems of a technology-driven approach are beginning to appear in a number of European countries. For one discussion of such problems in France, see Mark Hunter, "France's Grand Computer Plan in Shambles: Consumers Reject Domestic Machines Despite \$200 Million Purchase for National Schools," *The Washington Post*, Mar. 19, 1989, p. H-8.

<sup>83</sup>Eli M. Noam, "The Future of the Public Network: From the Star to the Matrix," *Telecommunications*, March 1988, pp. 58, 60, 65, 90. See also, "The Public Telecommunications Network: A Concept in Transition," *Journal of Communication*, vol. 37, No. 1, Winter 1987, pp. 30-47.

<sup>84</sup>For a discussion, see Wigand, op. Cit., footnote 24, pp. 48.

by 1990.<sup>85</sup> Similarly, the German Government, through the Deutsche Bundespost, has invested heavily in a network digitization program, which will lead to the availability of total ISDN by 1993.<sup>86</sup> Moreover, through the European Community, the countries of Europe have agreed to cooperate to build a “translational broadband backbone,” and to conduct joint research and development in advanced communication technologies through both the Research for Advanced Communications in Europe (RACE) program (which focuses on telecommunication), and the European Strategic Programme for Research and Development in Information Technology (ESPRIT) (which focuses on information technologies).<sup>87</sup> In addition, through the Commercial Action Committee of the Conference of European Postal and Telecommunications Administrations (CEPT), the Europeans are planning to develop a pan-European-managed data network.<sup>88</sup>

The Government of Japan has also retained “strategic policy control over the process of change”<sup>89</sup> in telecommunication and the structure of the telecommunication infrastructure. It has been especially active in promoting new technologies, making a commitment to invest over \$120 billion before 1995 for the development of a digital broadband infrastructure, the Information Network System (INS), and to provide \$150 billion through the Technopolis Program for model programs and pilot projects targeted to both business and residential users.

Such national efforts are not confined to the advanced industrialized countries. The governments of Singapore and Brazil, for instance, view their communication infrastructures as springboards that will allow their countries to pass over the industrial

phase of development and leap directly into the information age.<sup>90</sup> Given this perspective, it is not surprising that capital investment in Singapore, measured as a percentage of communication sales, is twice that of AT&T Long Lines and the seven RBOCs combined.<sup>91</sup>

A comparison of U.S. expenditures on communication with similar expenditures made in other countries can be seen in tables 12-2 and 12-3. As table 12-2 shows, based on the total amount of expenditures, the United States ranks at the top of the list. However, as evident from table 12-3, when a comparison is made based on the growth of total expenditures, the United States does not appear among the top 10 spending nations.

### *Factor 5: The fractionated decisionmaking process in the United States.*

The national commitment and direction noted above is in sharp contrast to the situation in the United States, where the government has not exerted strong leadership in determining and planning for the Nation’s future communication needs. Commenting on the U.S. approach to ISDN, Eli Noam observes, for example, that:

... virtually no public discussion of the ISDN concept and its investment needs has taken place. Instead decisions in favor of ISDN have been made outside of public view by engineering bureaucracies in government and equipment firms.<sup>92</sup>

Part of this lack of government leadership stems from the widespread belief among policymakers that the competitive marketplace is a more dynamic and appropriate force for innovation and change than the political arena. Equally important in explaining the lack of a comprehensive set of national communica-

<sup>85</sup>“The ISDN Lead,” *Communication International*, June 1987, pp. 30, 32.

<sup>86</sup>“Integrating ISDN,” *Communications International*, September 1988, pp. 44, 46.

<sup>87</sup>ESPRIT is a \$5.6 billion R&D program. According to the European Economic Committee’s 1987 report, 108 of the program’s first 227 research projects (referred to as Esprit 1) have been successfully completed, and have generated results of industrial significance. In phase 2, 155 new projects will be undertaken. ESPRIT is supported by nearly all of the large European communication, computer, and information technology suppliers, as well as by most large European research institutes.

<sup>88</sup>For a description, see Denis Gilhooly, “The CEPT MDNS Project—Work in Progress,” *Telecommunications*, April 1988, pp. 47-54.

<sup>89</sup>Michael Borrus and John Zysman, “The New Media, Telecommunications, and Development: The Choices for the United States and Japan,” BRIE Working Paper #7 (originally prepared for a symposium organized by the Japanese Ministry of Finance and the Japan Center for International Finance, August 1984), p. 22.

<sup>90</sup>See, for example, Debbie Shimman, “Asia Moves Into the Information Age,” *Telecommunications*, January 1989, pp. 55-57; see also Edward J. Nickoloff and Randolph Yeh, “Maintaining International Transmission Circuits Through a National Center,” *Telecommunications*, December 1988, pp. 52, 57, 58.

<sup>91</sup>William H. Davidson, “Telecommunication Policy in Global Perspective,” unpublished paper, Oct. 14, 1987.

<sup>92</sup>See, for a discussion, Noam, op. cit., footnote 83. See also Anthony M. Rutkowski, “Toward a National Information Fabric: Organizing for Success,” *Telecommunications*, September 1987, p. 8.

tion policy goals and strategies is the fact that, as detailed and discussed in chapter 13, the political decisionmaking structure is extremely fractionated, giving rise to a number of jurisdictional disputes. Because these conflicts allow, and even encourage, stakeholders to play agencies and jurisdictions off against one another, they serve to discourage attempts at cooperation and coordination. Moreover, by creating numerous uncertainties with respect to the outcomes of the policy process, they tend to exacerbate the problems that government and industry face in planning for the future.

## STRATEGIES AND OPTIONS

To encourage the modernization and development of the U.S. communication infrastructure, Congress could pursue three basic strategies. It could:

- follow the lead of many foreign countries and become more directly involved in developing, planning, financing, and coordinating the development of the communication infrastructure;
- provide indirect incentives to encourage long-term investment and development; and/or
- remove regulatory barriers that presently serve to discourage modernization as a consequence of furthering some other goal.

A discussion of these strategies, and individual options for achieving them, follows. A summary appears in figure 12-5.

### ***Strategy I: Direct government involvement in the development, planning, financing, and coordination of the communication infrastructure.***

As discussed in chapter 4, policymakers in the United States, in contrast with their counterparts in many other countries, have traditionally been reluctant to intervene in economic affairs. Instead, they have preferred that economic decisions be made through the processes and mechanisms of the marketplace. In recent years, this general predisposition against government involvement has been strongly reinforced by the prevailing mood of the

country in favor of deregulation. In such an environment, an exceptionally strong case would have to be made before adopting a strategy that goes against this trend.

There are, however, a number of arguments favoring a more direct Federal role in the realm of communication. Just as a Federal interest in national defense, economic development, and equity served to justify a Federal role in the development of highways and rural electrification, so too might communication networks be federally promoted as the highways of an information age. And just as the Federal Government provided over \$109 billion for highway construction during the 20-year period from 1956 to 1976,<sup>93</sup> so it could be argued that, today, government should make a comparable commitment to the development of a communication infrastructure. While arguments of this sort have not received much support in the Federal arena, they have been given a more favorable reception at the State level. For example, economic development issues are now being factored more and more into the decisions made by State regulators.<sup>94</sup>

Policy options that Congress might adopt to execute such a strategy include the following:

*Option A: Create a new legislative mandate for promoting the Nation's communication infrastructure that both updates the Nation's communication policy goals and clearly designates responsibility for implementing them.*

Goals are statements of values that serve to guide decisionmakers. They signal a commitment, identify aspirations, clarify objectives, and integrate diverse elements through the establishment of a common bond. Thus, one step that Congress might take to promote the modernization of the Nation's communication infrastructure would be to declare modernization as a national goal, and both delegate the responsibility and provide the organizational resources and authority required for it to be effectively carried out. To be specific enough, and to be sufficiently emphatic in setting such a goal, Congress would probably need to revisit and revise the 1934 Communications Act.

<sup>93</sup>U.S. Department of Transportation, Federal Highway Administration, *America on the Move: The Story of the Federal Highway program and the Federal-State Relationship*, 1977.

<sup>94</sup>Recently, for example, the New York State Public Service Commission undertook an investigation to determine whether New York State and New York City are in danger of losing a competitive advantage due to the failure of the area to foster ISDN. For a discussion, see John Foley, "N.Y. Probes ISDN," *CommunicationsWeek*, Sept. 26, 1988, p. 1.

Table 12-2—Top 20 Countries: Comparison of Total Expenditures for Communication, 1987-1988

Country	1988 expenditures (U.s.\$000,000)	1987 expenditures (U.s.\$000,000)	Total increase	Total decrease	Percent increase	Percent decrease
United States . . . . .	24,451.8	24,549.2		97.4		0.4
Japan . . . . .	13,761.5	12,178.3	1,583.1		13.0	
West Germany . . . . .	10,175.5	8,712.1	1,463.4		16.8	
France . . . . .	6,219.8	5,714.4	505.4		8.8	
Italy . . . . .	4,331.1	3,837.0	494.1		12.9	
United Kingdom . . . . .	3,547.4	3,322.0	225.4		6.8	
Spain . . . . .	3,148.2	2,341.0	807.2		34.5	
Canada . . . . .	2,746.6	2,443.6	303.0		12.4	
Switzerland . . . . .	1,859.3	1,623.2	236.1		14.5	
Korea . . . . .	1,836.8	1,525.8	311.0		20.4	
Sweden . . . . .	1,288.2	1,326.7		38.6		2.9
Brazil . . . . .	1,263.3	1,050.4	212.9		20.3	
Australia . . . . .	1,090.0	1,108.8		18.8		1.7
Austria . . . . .	1,048.1	913.6	134.5		14.7	
Taiwan . . . . .	902.5	702.7	199.8		28.4	
Netherlands . . . . .	769.7	695.5	74.1		10.7	
South Africa . . . . .	738.4	965.0		226.6		23.5
Norway . . . . .	706.2	621.7	84.5		13.6	
Belgium . . . . .	626.8	575.8	51.0		8.9	
India . . . . .	608.8	598.8	10.0		1.7	

NOTE: Totals may not add due to rounding.

SOURCE: Reprinted with permission from *Telephony*, Feb. 22, 1988, P.42.

Table 12-3—Top 10 Growth Budgets for Communication, 1987-88

Country	1988 expenditures (U.s.\$000,000)	1987 expenditures (U.s.\$000,000)	Total increase	Percent increase
Japan . . . . .	13,761.5	12,178.3	1,563.1	13.0
West Germany . . . . .	10,175.5	8,712.1	1,463.4	16.8
Spain . . . . .	3,148.2	2,341.0	807.2	34.5
France . . . . .	6,219.8	5,714.4	505.4	8.8
Italy . . . . .	4,331.1	3,837.0	494.1	12.9
Korea . . . . .	1,836.8	1,525.8	311.0	20.4
Canada . . . . .	2,746.6	2,443.6	303.0	12.4
Switzerland . . . . .	1,859.3	1,623.2	236.1	14.5
United Kingdom . . . . .	3,547.4	3,322.0	225.4	6.8
Brazil . . . . .	1,263.3	1,050.4	212.9	20.3

NOTE: Totals may not add due to rounding.

SOURCE: Reprinted with permission from *Telephony*, Feb. 22, 1988, p. 43.

Many countries throughout the world have already made this kind of national commitment to developing a modern communication infrastructure. However, in the United States, establishing national goals on this order—especially in the realm of communication policy—has been much more rare.<sup>95</sup> The reluctance to set such goals reflects not only the pragmatic style of American politics in general, but

also the highly contentious and politicized nature of most communication issues.

At the present time, however, reaching a new legislative consensus may not be as difficult as it has been in the past. The situation is very fluid; past alliances are in a state of flux, technology is rapidly advancing, and the nature of the future communica-

<sup>95</sup>As we have seen, basic U.S. communication policy was first established at the Constitutional Convention when the delegates agreed to include within the Constitution three clauses that provided for freedom of the press, the protection of intellectual property, and the establishment of postal roads. It took almost 150 years, however, for the legislature to debate and establish additional, national communication goals, first in 1912 and 1927 with the passage of the Radio Acts, and subsequently in 1934, with the passage of the Communications Act. Although Congress did re-evaluate communication goals again from 1976 to 1980, these efforts to revise the 1934 Communications Act failed for a lack of consensus. For a discussion, see Eric C. Krasnow, Lawrence D. Langley, and Herbert Terry, *The Politics of Broadcast Regulation* (New York, NY: St. Martin's Press, 1982).



**Figure 12-5—Congressional Strategies and Options To Address Modernization of the Communication Infrastructure**

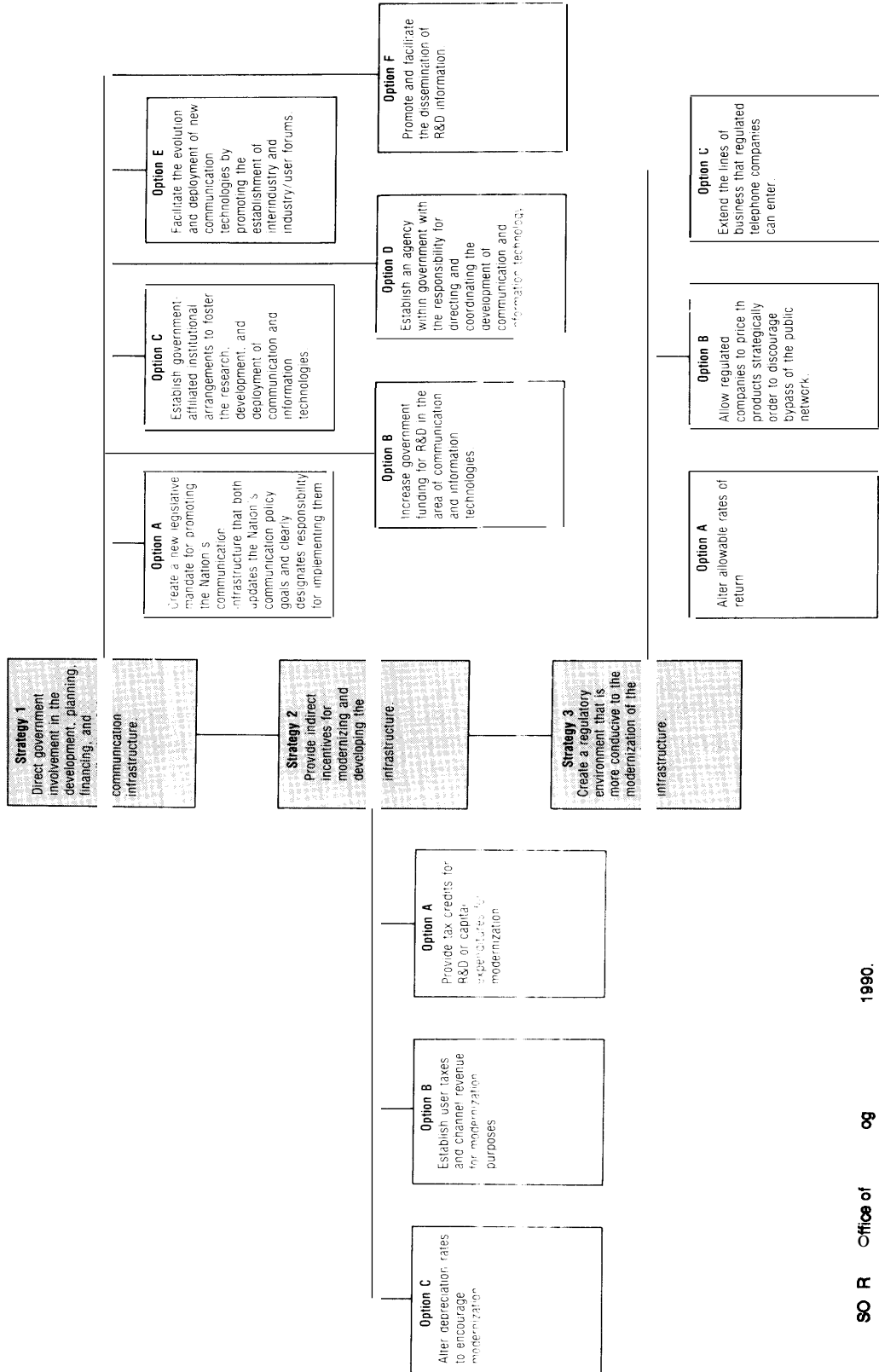

tion infrastructure is still quite uncertain. This situation may provide Congress with a window of opportunity. Requiring some resolution of the issues, many stakeholders agree that “something” must be done. Moreover, not knowing what the future entails and how their interests might fare in relationship to it, stakeholders may be much more willing to cooperate in updating and redefining the goals and rules of operation of the communication infrastructure. As John Rawls observes in *A Theory of Justice*, it is often easier for people to agree among themselves on rules of the game when the situation is uncertain—that is, when they do not know whether, as participants, they will start out from a position of advantage or disadvantage.<sup>96</sup>

*Option B: Increase government funding for research and development in the area of communication and information technologies.*

As described in chapter 4, the United States has a long tradition of funding scientific and technical research and development. Although the amount of funding has tended to fluctuate in accordance with perceived science crises, such as Sputnik, policymakers have generally been in agreement about the need for such support.<sup>97</sup> Most recently, there has been a decline in the amount of money the Federal Government allocates to R&D that is not defense-related. However, concerns about the ability of the United States to compete effectively in the global, high-technology marketplace have led to proposals calling for greater funding. Reflecting these concerns, over 200 R&D bills were introduced in Congress in the past 2 years, 12 of which were

related to communication and information technologies.

One problem in providing government funding for R&D is determining what constitutes an appropriate amount of funding and how such a sum might be deployed effectively. This problem stems, in large measure, from our limited understanding of the relationships between R&D and innovation. Compounding this is the fact that, as economists Richard Nelson and Nathan Rosenberg have pointed out, choices about the type and amount of R&D support can only be determined on a case-by-case basis.<sup>98</sup>

In evaluating proposals to increase government funding of R&D, one key question is whether communication technology merits greater support than other technologies.<sup>99</sup> Recognizing the need to make such choices, a government panel (led by the presidents of the National Academy of Sciences, the National Academy of Engineering, and the Institute of Medicine) urged in a recently released report, “Federal Science and Technology,” that the White House and Congress be much more systematic about setting priorities for Federal spending on science and technology.<sup>100</sup>

In the case of communication technologies, the argument could be made—as it has been in Europe and Japan—that they are unique, insofar as they constitute part of a nation’s underlying economic and social infrastructure. In the United States, semiconductor technology has received R&D support on the grounds that this technology is critical to maintaining both a sound defense and a competitive national economy.<sup>101</sup> In fact, to support **the** super-

<sup>96</sup>John Rawls, *A Theory of Justice* (Cambridge, MA: Belknap Press, 1971).

<sup>97</sup>As pointed out in ch. 4, the role of government in supporting R&D has been based on the assumptions that: 1) new knowledge is a necessary condition for economic growth; 2) new knowledge originates in basic research; 3) the supply of knowledge is unlimited, and is not subject to diminishing returns; 4) the government should support basic research in support of national security, the economy, for reasons of health, etc.; and 5) industry lacks the economic incentive to conduct the socially optimum amount of research. William Leiss, “Industry, Technology and the Political Agenda in Canada: The Case of Government Support for R&D,” *Science and Public Policy*, vol. 15, No. 1, pp. 57-65. For a discussion, see also Roger G. Nell and Linda Cohen, “Economics, Politics and Government Research and Development,” Working Papers in Economics, E-87-55, The Hoover Institute/Stanford University, Stanford, CA, December 1987.

<sup>98</sup>For general discussions by Rosenberg of the problems entailed in technological change and innovation, see Nathan Rosenberg, *perspectives on Technology* (London, England: Cambridge University Press, 1976) and *Inside the Black Box—Technology and Economics* (Cambridge, MA: Cambridge University Press, 1982). See also, Richard Nelson, testimony, *Communications and Computers in the 21st Century*, hearings before the Technology Policy Task Force of the House Committee on Science, Space, and Technology, June 25, 1987 (Washington, DC: U.S. Government Printing Office, 1987).

<sup>99</sup>Nelson makes this point in his testimony. Ibid.

<sup>100</sup>A, the report notes: “In a period of limited resources, there is an even greater premium on making the best-informed budget allocations possible.” As cited in Colleen Cordes, “Panel of Top Scientists Urges White House and Congress To Set Research Priorities Before Deciding on Funds,” *The Chronicle of Higher Education*, Jan. 4, 1989, pp. A1, A22.

<sup>101</sup>A similar case has been made for superconductivity. See the Report of the Committee to Advise the President on High Temperature Superconductivity, *High Temperature Superconductivity: Perseverance and Cooperation on the Road to Commercialization*, The White House Science Council, January 1989.

conductor industry, the Department of Defense (DoD) has recently decided to undertake research on high definition television (HDTV), as described below. Advanced computer technology has also been suggested as an area requiring government support.<sup>102</sup> Concerned about the state of the U.S. economy, the National Research Council recently noted, for example, **that**:

**The U.S. position in this [the superconductor] field is threatened from without by external competition and from within by underappreciation of the need for basic research.**<sup>103</sup>

In considering the amount of R&D funding, it is also necessary to address the question of how such government monies are **to** be employed. Public support for **a** government role in R&D has tended to decline as government programs have increasingly moved away from programs targeted **to** basic research towards programs in support of applied research.<sup>104</sup> However, in recent years, a number of economists have pointed out that, in terms of meeting the challenge of competition, it is perhaps in the **area** of applied research that the greatest efforts need **to** be made.<sup>105</sup> In this regard, **a** number of people have specifically cited telecommunication research as an area requiring a greater market perspective, given its long tradition of focusing on basic research.<sup>106</sup>

Alternative ways of using government R&D funding are discussed further in the options that follow. However, it should be noted that, as Roger Nell and Linda Cohen have emphasized, the political context in which R&D decisions are generally made and implemented is not particularly well-suited to making funding choices based on what has generally been considered to be the soundest criteria for supporting R&D. As they point out:

... most programs are not clearly a waste of money, especially in early exploratory research. The problems arise because mid-project managerial decisions are directed from matters of economic efficiency by a host of political factors: impatience to show commercial progress, distributive politics, the inability to commit to long term, stable programs, and a mismatch between the types of industries that are most likely to underinvest in research and those that are most attractive politically to subsidize.<sup>107</sup>

*Option C: Establish government-affiliated institutional arrangements to foster the research, development, and deployment of communication and information technologies.*

Today, the governments of Europe and Japan are focusing their national research efforts on commercial development in high-technology areas such as electronics, biotechnology, material research, and informatics. In the area of HDTV, for example, the European Community is establishing a special company to foster the worldwide use of the Eureka HDTV standard, which has been developed by its leading electronic firms, including Philips, France's Thomson SA, West Germany's Bosch BMbh, and Finland's Nokia.<sup>108</sup>

In contrast to these countries, where there is general agreement that R&D should be conducted in support of general economic development, most industrial-related R&D in the United States is executed on behalf of Federal agencies, the most prominent being the (DoD).<sup>109</sup> Most recently, for example, DoD has decided to fund the development of an advanced high resolution video display, not only as a means of providing high-quality display technology for military purposes, but also as a way of fostering the revival of U.S. television manufac-

<sup>102</sup>"Defense Department Wants i, the HDTV Picture," *Broadcasting*, vol. 115, No. 26, Dec. 26, 1988, pp. 32-33; and "The U.S. 's Semiconductor Battle Plan," *ibid.*, p. 33.

<sup>103</sup>As cited in, Mitch Betts, "Federal Panel: Aim High in R& D," *Computerworld*, Nov 28, 1988, p. 95.

<sup>104</sup>And, as Roger Noll and Linda Cohen have pointed out, political support is not necessarily equated with those projects that would benefit most from government intervention in support of R&D. For a discussion, see Nell and Cohen, *op. cit.*, footnote 97.

<sup>105</sup>For one discussion, see Nathan Rosenberg and W. Edward Steinmueller, "Can Americans Learn to Become Better Imitators?" CEPR Publication No. 117, Center for Economic Policy Research, Stanford University, Stanford, CA, January 1988.

<sup>106</sup>For one discussion, see Michael Schrage, "Bell Labs Is Long on Genius But Short in the Marketplace," *The Washington Post*, Mar. 1, 1987. For another account of post-divestiture research at Bell Labs, see Denis Gilhooly, "A Mission From AT&T," *Telecommunications*, February 1988, pp. 26, 30, 33.

<sup>107</sup>Noll and Cohen, *op. cit.*, footnote 97.

<sup>108</sup>For a discussion of national HDTV strategies, see Hugh Carter Donahue, "Choosing the TV of the Future," *Technology Review*, vol. 92, No. 3, April 1989, pp. 30-40; and Alan G. Stoddard and Mark D. Dibner, "Europe's HDTV: Timing Out Japan," *Technology Review*, April 1989, pp. 39-40.

<sup>109</sup>Leonard L. Lederman et al., "Research Policies and Strategies of Five Industrial Nat Ions, and Implications for the United States," *Science and Technology Studies*, vol. 4, No. 1, p. 25.

turing and semiconductor industries.<sup>110</sup> NASA has also been conducting R&D on HDTV, but on a much smaller scale than that proposed by DoD.<sup>111</sup>

Today, there are over 15,000 individual organizations in the United States associated with government labs. Given their number and variety, it is difficult to generalize about the pros and cons of this kind of government-affiliated research. However, as illustrated in box 12-B,<sup>112</sup> there are both benefits and costs associated with conducting research in government-affiliated research organizations. Any government decision to fund research in communication and information technologies would need to take these into account.

*Option D: Establish an agency within government with the responsibility for directing and coordinating the development of communication and information technologies.*

Given the divestiture of AT&T and the decentralized and fractionated nature of the U.S. communication policymaking process, it is not surprising that, in the United States today, there is no central, organizational focal point for conducting R&D in communication and information technologies.<sup>113</sup> Commenting on the lagging state of R&D in the United States, many of those involved in technology development and innovation processes have recently argued that if sufficient research is to take place, there needs to be an organizational focal point, and advocate, for it within government. Testifying in 1987 before the Technology Policy Task Force, Professor Lewis Branscomb of the John F. Kennedy School of Government, Harvard University, noted, for example, that:

The Department of Commerce as currently constituted and as constituted in most of its history has no

particular stomach for a more active role of this kind, notwithstanding the large number of scientific and technical agencies in the Department. Their missions are very neatly circumscribed and don't constitute in any sense an open-ended obligation to try to negotiate partnerships with the private sector that come to grips with these technology issues.<sup>114</sup>

One recent step to try to rectify this situation has been to enhance the role of technology development within the Department of Commerce by reconstituting the National Bureau of Standards (now the National Institute of Standards and Technology), providing it with more responsibilities in this area.<sup>115</sup> Another suggested alternative is to reconstitute the Office of Science and Technology Policy within the Office of the White House, connecting it in some formal way with the Council of Economic Advisors to give it the prominence and authority it would require.<sup>116</sup>

While such alternatives would address some of the more general problems of R&D in the United States, they would in no way assure that communication and information technologies would be targeted for R&D. In fact, such organizational arrangements would serve to enhance the competition among technologies for funds—a situation, it should be emphasized, that would be welcomed by most science policy experts. Thus, to promote R&D in communication technologies, per se, might require expanding the role of technology development within the Federal Communications Commission (FCC).<sup>117</sup>

*Option E: Facilitate the evolution and deployment of new communication technologies by promoting the establishment of interindustry and industry/user @-urns.*

<sup>110</sup>Evelyn Richards, "Pentagon Aims To Revive U.S. TV Industry," *The Washington Post*, Dec. 19, 1988, p. 1.

<sup>111</sup>*Broadcasting*, Jan. 2, 1989, pp. 94, 98.

<sup>112</sup>Barry Bozeman and Michael Crow, "U.S. R&D Laboratories and Their Environments: Public and Market Influence," final report to the National Science Foundation, Science Resource Studies, Mar. 1, 1988.

<sup>113</sup>This lack of a coordinated R&D effort was noted, and its impact analyzed, even before divestiture. For such a discussion, see Glen O. Robinson, "Communications for the Future: An Overview of the Policy Agenda," *Communications for Tomorrow. Policy Perspectives for the 1980s* (New York, NY: Praeger, 1977), ch. 14. At that time, Robinson concluded that the lack of coordination in R&D planning and investment did not constitute a serious problem.

<sup>114</sup>Lewis Branscomb, *Cements, Communications and Computers in the 21st Century*, Hearing before the Technology Policy Task Force Of the House Committee on Science, Space, and Technology, June 25, 1987 (Washington, DC: U.S. Government Printing Office, 1987), p. 65.

<sup>115</sup>These changes, as well as the change in name, were provided in Public Law 100-418, Subpart A.

<sup>116</sup>Nelson, op. cit., footnote 98, p. 69

<sup>117</sup>The office of Plans and Policy, which would be expected to undertake such analysis, has often been forced by budgetary constraints into more routine agency affairs, to the neglect of long-range policy analysis and planning. Increased congressional funding, provided specifically for this task, might improve the situation. For a discussion, see Robinson, op. cit., footnote 113, p. 381.

Another mechanism for promoting and coordinating the development of R&D in the area of information and communication technologies would be to facilitate the establishment of interindustry, industry/university, and industry/user forums to conduct such activities. An approach that calls for cooperation among such groups could be aimed not only at reducing the total costs of conducting R&D, but also at improving the R&D process by more closely integrating its science, research, and developmental aspects. Such an approach has become increasingly popular in recent years among both innovation experts and stakeholder groups, especially in high-technology areas where the costs of R&D are exceptionally high. For example, the consortium approach was recommended by the Committee to Advise the President on High Temperature Superconductivity.<sup>118</sup> And, most recently, the American Electronics Association has proposed a government-industry consortium for the development of HDTV:<sup>119</sup>

One major law that has sought to foster such cooperative research agreements is the Stevenson-Wydler Technology Act of 1980,<sup>120</sup> which authorizes the provision of Federal seed money for a period of 3 years to help establish research joint ventures between industry and universities and other non-profit institutions. As amended by the Federal Technology Transfer Act of 1986,<sup>121</sup> this act establishes an Office of Productivity, Technology, and Innovation within the Department of Commerce with responsibility, among other things, for identifying technological needs, problems, and opportunities; encouraging and assisting the creation of centers and other joint initiatives; encouraging technology transfer; stimulating innovation and promoting investment in technology-related industries; and publishing the results of studies and experiments. In accordance with that act, an Office of Industry Technology has been established within the Department of Commerce.<sup>122</sup>

This cooperative approach has been facilitated, moreover, by the enactment of the 1984 National Cooperative Research Act.<sup>123</sup> This act reduced the

### **Box 12-B--Summary of Market and Government Influence**

#### **Increased governmental influence implies:**

- . More basic research
- More cooperative research
- More bureaucratization
- Fast release of new knowledge
- More technology transfer to the commercial sector
- Heavy emphasis on technology transfer to the government
- . Moderate to high levels of applied research
- Increased focus on scientific effectiveness
- Heavy dependence on government funding
- Stability for enhanced R&D productivity
- More outmoded research equipment
- Tendency to be policy and technology v. market driven research organizations (exception is the Public Market Laboratories)
- Greater and more numerous barriers to R&D productivity
- Generally larger research organization
- General shortage in scientific personnel
- Higher levels of interorganizational complexity
- Knowledge outputs are variable and mixed including both proprietary and nonproprietary products

#### **Increased market influence implies:**

- Almost total focus on applied research
- . Lower levels of cooperative research
- . Slower release time for new knowledge
- . General concentration in engineering and the traditional sciences
- Less interdisciplinary research
- Except for Public Market and Quasi-Public/Multi-Market laboratories, a generally smaller R&D environment niche

SOURCE: Barry Bozeman and Michael Crow, *U.S. R&D Laboratories and Their Environments: Public and Market Influence*, Final Report to the National Science Foundation, Science Resource Studies, Mar. 1, 1988, p. 18.

<sup>118</sup>See *High Temperature Superconductivity*, op. cit., footnote 101.

<sup>119</sup>"\$1.35 Billion Sought for HDTV Consortium," *The Washington Post*, May 10, 1989, p F-1.

<sup>120</sup>Public Law 96-480.

<sup>121</sup>Public Law 96-480, 94 Stat. 2311, 15 U.S.C. 3701.

<sup>122</sup>15 U.S.C. 3704 (c).

<sup>123</sup>Public Law 98-462, 98 Stat. 1815, 15 U.S.C. 4301.

risk that companies face in entering such agreements with respect to antitrust liability.

Industry participants have generally favored the consortium approach, arguing that the cost of R&D is too high for anyone company to handle on its own. However, a number of people in the industry believe that Congress should focus its policies on a broad segment of the U.S. economy and not just on one technology. As the Electronics Industry Association has pointed out with respect to HDTV:

HDTV is not the answer to all of America's problems in competitiveness . . . There is a danger connected with equating the competitiveness of a nation with that of a single industry. While a single industry may be symbolic of general, national problems of competitiveness, certain policies designed to promote the revival of such symbolic industries may be prejudicial to the solution of the wider problem of competitiveness.<sup>124</sup>

*Option F: Promote and facilitate the dissemination of R&D information.*

Another problem associated with R&D in the United States is that of technology transfer and the dissemination of R&D information.<sup>125</sup> Some efforts have been made to foster the dissemination of research information from Federal laboratories.<sup>126</sup> But the government has "no coherent, centrally organized, or systematically designed approach to deal with disseminating information created by the basic research community."<sup>127</sup> Therefore, one option that Congress might adopt to foster the modernization of the communication infrastructure is to promote and facilitate the dissemination of R&D information in this area. In this regard, a number of computer scientists and government officials have urged Congress to create a "data superhighway," and

legislation to this effect has recently been introduced into Congress.<sup>128</sup>

Although relevant to the issue of modernization, this option will not be discussed in detail here, since it is the subject of a subsequent OTA study.<sup>129</sup>

***Strategy 2: Provide indirect incentives for modernizing and developing the communication infrastructure.***

A second strategy that might be employed to encourage modernization of the communication infrastructure is that of providing indirect financial incentives to the private sector. Such incentives might take the form of tax credits or changes in allowable depreciation rates, for example. As discussed in chapter 4, in the past, such incentives were not required because the regulatory structure itself served to generate financing for R&D and capital expenses with what was, in effect, a user tax.<sup>130</sup> Today, however, such monies are no longer as readily available. While it appears that competition among providers for the business of large users has served as an effective incentive for investment in modernization,<sup>131</sup> it is questionable whether there will be enough incentive to bring about the modernization of the public communication infrastructure within a "suitable" timeframe. Public utility commissions (PUCs) have been reluctant to allow their local exchange carriers (LECs) to employ "excess" profits for modernization purposes, preferring instead to pass them back to ratepayers in the form of lower rates or rebates.<sup>132</sup>

If Congress wishes to implement this strategy, a number of options could be considered.

*Option A: Provide tax credits for R&D or capital expenditures for modernization.*

<sup>124</sup>As cited in "Action Memos Offer HDTV Choices," *Broadcasting*, Feb. 6, 1989, p. 57.

<sup>125</sup>For a general discussion, see Tora K. Bikson, Barbara E. Quint, and Leland L. Johnson, "Scientific and Technical Information Transfer: Issues and Options, March 1984," The National Science Foundation, #N-213 1-NSF.

<sup>126</sup>See, for example, the Federal Technology Transfer Act of 1986, Public Law 99-502, Oct. 20, 1986.

<sup>127</sup>Bikson, Quint, and Johnson, op. cit., footnote 125.

<sup>128</sup>s. 2918, the National High-Performance Computer Technology Act of 1988, was introduced by Senator Albert Gore in October 1988. See also John Markoff, "A Supercomputer in Every Pot: Network is Planned for Broader Access," *The New York Times*, Dec. 29, 1988, p. 1, and Business Section, p. 4.

<sup>129</sup>For a discussion, see OTA project proposal, "Information Technology and Research," in progress.

<sup>130</sup>For a discussion, see Loretta Anania and Richard Jay Solomon, "Capital Formation and Broadband Planning: Can We Get There From Here?" *Telecommunications*, November 1987, pp. 26, 28.

<sup>131</sup>One recent example of the competitive incentive for modernization is AT&T's decision to take a "\$6.7 billion pre-tax charge in the fourth quarter because exploding demand for high tech long-distance service is forcing it to speed up modernization of its phone network." Janet Guyon, "AT&T to Take a \$6.7 Billion Charge in Period," *The Wall Street Journal*, Dec. 2, 1988, p. A-3.

<sup>132</sup>For one recent discussion of this issue, see Glen Abel, "Southwestern Bell upgrade," *CommunicationsWeek*, Jan. 9, 1989, p. 6.

While the overall effect of the Tax Reform Act of 1986 was to significantly reduce the taxes owed by local exchange telephone companies—and hence their revenue requirements and rates—the repeal of the 10-percent regular investment tax credit has dampened the incentives of telephone companies to modernize the network. The regular investment tax credit had encouraged investments because it permitted telephone companies to retain a portion of the tax savings that it created. Thus, this tax credit benefited the telephone companies, their shareholders, and ratepayers, whose rates declined in the face of lower revenue requirements.

To encourage modernization, Congress could reinstate the investment tax credit for telephone companies, and it could be specifically targeted to new plant and equipment that serves to modernize the public network. A broader credit could also apply to any R&D that is directly related to such plant and equipment, although experience suggests it is not an easy task to allocate such costs. Such a tax would benefit telephone companies, ratepayers, and equipment suppliers. However, general ratepayers might actually end up paying more if the tax revenue foregone had to be made up through an increase in general tax rates.

*Option B. Establish user taxes and channel revenue for modernization purposes.*

The construction of the public infrastructure has often been financed by imposing special taxes on users and potential users of that infrastructure. For example, the construction and maintenance of public roads and highways have traditionally been financed in part from specifically earmarked gasoline taxes as well as from user-fee tolls.<sup>133</sup> A similar Airport and Airway Trust Fund—accumulated from taxes on airline tickets and airplane fuel—is available to fund the infrastructure needs of the air travel industry.<sup>134</sup> In like fashion, an option for generating additional capital for modernizing the Nation's communication

infrastructure might be to impose user taxes that would be earmarked for infrastructure development.

It should be noted that there is already a special Federal communication tax imposed on telephone bills, which has historically ranged from 10 to 20 percent. However, the revenue collected to date (an estimated \$2.5 billion in 1988)<sup>135</sup> has not been earmarked for telephone or other infrastructure development, but has been treated as undesignated revenues. There are also a number of miscellaneous State and local taxes, which totaled an estimated \$2.5 billion in 1988.<sup>136</sup> In the future, these monies might be targeted to infrastructure development.

Assuming a genuine need for financial incentives and support, using revenues from user taxes to provide them would be preferable to using general purpose funds on the grounds of both equity and efficiency. As Alice Rivlin, former Director of the Congressional Budget Office, has noted:

User charges represent a way of recapturing from the actual beneficiaries some of the costs to the general public. Levying user charges promotes economic efficiency because users pay, directly or indirectly, for the services they receive. Proper incentives are provided, since heavier use imposes greater costs on the user, and at the same time, generates revenues to expand facilities.<sup>137</sup>

There are, however, a number of general problems associated with providing financing from earmarked sources of funds. Once established, such a fund can take on a life of its own. Since revenue is obtained from earmarked taxes, such funds can circumvent the normal budgetary process. As a result, it is often difficult to evaluate spending decisions in the light of other social values. Moreover, in these circumstances, the allocation of funds may be inflexible in the face of changing societal needs.

User taxes to support the modernization of the communication infrastructure may be unpopular, insofar as users have communication needs that are

<sup>133</sup>For a discussion, see U.S. Congress, Office of Technology Assessment, *Changes in the Future Use and Characteristics of the Automobile Transportation System*, vol. II, (Springfield, VA: National Technical Information Service, 1979), pp. 253-261.

<sup>134</sup>U.S. Congress, Office of Technology Assessment, *Airport System Development*, OTA-STI-231 (Springfield, VA: National Technical Information Service, 1984), p. 139.

<sup>135</sup>A 3-percent Federal excise tax has been imposed on telephone usage for more than 50 years (26 U.S.C. 4251). Approximately \$2.61 billion was collected through the Federal excise tax in 1988, and 1990 revenues are estimated at \$2.95 billion. Staff, Joint Committee on Taxation, Schedule of Present Federal Excise Taxes (as of January 1989), p. 21.

<sup>136</sup>Data provided by U.S. Advisory Commission on Intergovernmental Relations, March 1989. Interestingly, some of these taxes are earmarked for specific purposes unrelated to communication, such as a special New York City surcharge designated for the use of the transit authority.

<sup>137</sup>Statement of Alice M. Rivlin, Director, Congressional Budget Office, before U.S. Congress, Senate Committee on Public Works, Feb. 7, 1978, p. 8.

distinct from one another. Many residential consumers are strongly opposed to paying higher rates to finance modernization on behalf of other communication users.<sup>138</sup> In addition, shifting tax revenue from the general pool of tax revenue to support communication-related activities may increase the problems of the budgetary deficit, if the services that the general tax on telephone service previously supported are still considered to be essential. Furthermore, given the decentralized and pluralistic nature of the U.S. communication infrastructure, the political and administrative problems associated with collecting and allocating user taxes for the purposes of modernization would be extremely difficult to resolve.

*Option C: Alter depreciation rates to encourage modernization.*

Capital expenses are recovered over time according to depreciation schedules designed to reflect how fast capital assets are expended. The higher the rate of depreciation, the faster that capital is recovered, and the more quickly revenues are made available for additional investments. For regulated telephone companies, depreciation expenses constitute the primary internal means of generating funds for capital replacement.<sup>139</sup>

Given this relationship between depreciation rates and capital expenditures, one way in which Congress might seek to encourage investment in the modernization of the public communication infrastructure would be to increase the rates at which regulated companies could depreciate their equipment. Reconsideration of depreciation policy is most likely to be called for at times when the pace of technological change is accelerating rapidly. This would appear to be the case now, as the useful lifetimes of many communication technologies become shorter and shorter.

Depreciation rates for regulated telephone service providers are established by both the FCC and the State PUCs, with the former setting depreciation rates for capital expended on interstate communication, and the latter setting rates for intrastate communication services. Beginning in 1980, the FCC adopted a number of changes with respect to determining depreciation rates that were designed to take into account advances in technology. Disagreements still exist, however, as to which rates are appropriate, with many telephone companies arguing that higher depreciation rates are required if modernization is to proceed apace. Many States have also taken issue with Federal depreciation policies, but from an opposite perspective. Focusing on the costs of local service, they have been much less inclined to adjust their depreciation rates for the sake of modernization.\*<sup>140</sup> And the Supreme Court has supported the States' rights to an independent position, ruling—in the case of *Louisiana Public Service Commission v. Federal Communications Commission*--that in the 1934 Communications Act, Congress did not want to preempt the States on depreciation issues generally.<sup>141</sup> Thus, if depreciation policy were to serve as an important component of a Federal strategy to modernize the Nation's communication infrastructure, Congress would need to specifically authorize the FCC to preempt State action in this area.<sup>142</sup>

***Strategy 3: Create a regulatory environment that is more conducive to the modernization of the communication infrastructure.***

Government regulatory policies can have a major impact on corporate planning and decisionmaking. Thus, one strategy that Congress might follow would be to configure the regulatory environment to create greater incentives for business to invest in modernizing the communication infrastructure. At

<sup>138</sup>The public's reluctance to pay a user tax to finance a broad communication policy goal was, for example, clearly an important factor in Congress's decision not to follow the Carnegie Commission's recommendation to fund public television through an excise tax on television sets. For a discussion, see Stephen White, "Our Public Television Experiment," *Current*, Oct. 20, 1988, pp. 7, 10-11. For a discussion of public broadcasting's failure to achieve the vision of its founders, see Harry M. Shooshan 111 and Louise Arnheim, "Public Broadcasting," *Benton Foundation Project on Communications and Information Policy Options* (Washington, DC: Benton Foundation, 1989).

<sup>139</sup>According to Nousaine, Brant, and Murray: "For a typical Bell operating company, depreciation often supplies 75% of the funds for capital spending and accounts for almost 25% of total expenses, excluding taxes." *Op. cit.*, footnote 32, p. 52

<sup>140</sup>In fact, political pressure to keep local telephone rates low has led to substantial underdepreciation in the past; thus, the book value of telephone company investments far exceeds current market value. The most widely cited estimate of this excess is on the order of \$25 billion. See Alfred E. Kahn and William B. Shew, "Current Issues in Telecommunications Regulation: Pricing," *Yale Journal on Regulation*, vol. 4, No. 2, Spring 1987, pp. 191, 222, 243-246.

<sup>141</sup>For a discussion, see Roger M. Witten and Thomas F. Connell, "The Louisiana PSC Decision: Where the Federal-State Balance of Power Stands," *Teleomatics*, vol. 3, No. 7, July 1986.

<sup>142</sup>Such authorization would, of course, be subject to constitutional review.



present, there are three basic policy approaches being considered in this regard--one that would alter the permitted rate-of-return that regulated companies can earn; one that would allow for more flexible pricing policies; and one that would expand the lines of business that companies can enter.

To pursue this strategy, Congress has a number of options.

*Option A: Alter allowable rates of return.*

The option of adopting alternatives to rate-of-return regulation has already been discussed in considerable detail in chapter 9, which focuses on access issues. The discussion here describes only how this option relates to the issue of modernization.

Proponents of alternatives to rate-of-return regulation argue that it stifles modernization by discouraging investments in R&D and productivity-enhancing technologies. In their view, regulated companies will be unlikely to invest in upgrading or modernizing their networks because they cannot fully recover the outlays they incur.<sup>143</sup> It is argued that an alternative arrangement, such as a system of price caps, would allow communication providers to recoup these costs, thereby encouraging them to make investments in the network. In making this argument, it has been noted, for example, that the RBOCs commit only 1.4 percent of their total operating revenues to R&D--about 40 percent of the amount committed by other industry groups in the United States.<sup>144</sup> Moreover, since the price of services could be capped at some negotiated and agreed-upon level, such a system would buffer local ratepayers from higher prices and the risks entailed in modernization.<sup>145</sup> In addition, because providers alone would bear the cost of failure, they would have a strong incentive to think through their investment decisions very carefully.<sup>146</sup>

Some opponents challenge the basic assumption underlying this option. They contend that rate-of-return regulation has not discouraged modernization in the past, nor is it likely to do so in the future. As Mark Cooper, Director of Research for the Consumer Federation of America, has argued:

This stellar performance was driven by a rate of growth in total factor productivity--the best measure of an industry performance--that was almost 3 times greater than the average for all nonresidential businesses. Pure technological progress--measured by what economists call the residual--appears to be higher too by about one-third. The manufacturing part of the industry, where technological progress takes place, has exhibited a much higher rate of investment in research and development than other manufacturing industries. At the same time, the industry has been making capital expenditures at a much faster rate than the Standards and Poor 400, while it earned a rate of return that was about a point and a half below that of the Standard and Poor 400.<sup>147</sup>

Others, while commending the goals of modernization, do not believe that the price-cap proposals as presently devised go far enough to protect the customer against excessive rates, or the telephone companies' competitors from cross-subsidies and predatory pricing. For example, testifying on S.2044 (a bill requiring further FCC review of its price-cap proceeding),<sup>148</sup> before the Subcommittee on Communications of the Senate Commerce, Science, and Transportation Committee, Gail Garfield Schwartz, Deputy Chairman, New York State Public Service Commission, challenged FCC's reliance on an indexed cap incorporating a productivity adjustment based on historical performance (2.5 percent).<sup>149</sup> As she points out:

No historical productivity factor can guarantee fair treatment for ratepayers, because any factor based on historic performance is likely to diverge

<sup>143</sup>For this argument, see Robert T. Blau, "The Politics of Productivity: Reshaping Telecommunications Policy in the 1990s," *Telematics*, vol. 5, No. 10, October 1988, pp. 1-7.

<sup>144</sup>*Ibid.*; see also R. Harris, "The Implications of Divestiture and Regulatory Policies for Research, Development and Innovation in the U.S. Telecommunication Industry," Berkeley, CA, 1987.

<sup>145</sup>For this argument, see Leland L. Johnson, "Price Caps in Telecommunications Regulatory Reform," N-2894-MF/RC (Washington, DC: The Rand Corp., January 1989). See also Peter Huber, *op. cit.*, footnote 50.

<sup>146</sup>*Ibid.*

<sup>147</sup>Mark N. Cooper, "Regulatory Reform in Telecommunications: A Solution in Search of a Problem," *Telematics*, vol. 4, No. 11, November 1987, pp. 1-7.

<sup>148</sup>CC Docket 87-313.

<sup>149</sup>Testimony of Gail Garfield Schwartz, Deputy Chairman, New York State Public Service Commission, before the Subcommittee on Communications, House Committee on Commerce, Science, and Transportation, on S.2044, Legislation to Require Further Review by the FCC of its So-Called Price Cap Proceeding (CC Docket 87-313), Aug. 2, 1988, p. 2.

from actual future performance. Thus, it is especially ironic that the FCC defends so strongly as a consumer benefit a factor reflecting historical experience under rate-of-return regulation, which admittedly discourages efficiency. If the inefficiencies of the former regime were as great as claimed, surely the theoretically more efficient regime of price caps should result in a higher-than-historic productivity increase.<sup>150</sup>

Opponents of alternative regulatory approaches also point to the negative effects that such methods might have on modernization. They note that, although telephone companies would continue to have incentives to modernize their competitive services, price-cap regulations might encourage them to allow the deterioration of facilities that serve captive customers. Any new system, they argue, should require that telephone companies meet strict quality-of-service standards and establish the procedures necessary for enforcing such standards.

As noted in chapter 9, the FCC approved a revised price-cap plan for AT&T on March 16, 1989. Consideration is presently being given to extending such a plan to the RBOCs, although opposition to such an extension would be much greater in this case because competition is much weaker at the level of the local exchange. Responding to FCC price-cap initiatives, Edward J. Markey, Chairman of the House Telecommunications Subcommittee—with the co-sponsorship of 13 other subcommittee members—introduced the Telephone Rate Verification Act, which would require the FCC to submit reports to Congress comparing the current rate-of-return regulations with price caps, based on data supplied by AT&T.

*Option B: Allow regulated companies to price their products strategically in order to discourage bypass of the public network.*

If the public communication infrastructure is to be maintained and modernized, providers of communication services will need to operate at a sufficient level of scale and scope to make investments in their networks worthwhile. To assure such economies, providers will need to find ways to keep big-volume

users, such as large businesses, from migrating to other networks. However, regulated providers have been limited in their ability to do so. While their unregulated competitors can discriminate among users in their offerings of communication services, regulated telephone companies cannot unless they have secured a special waiver from State or Federal regulators.

One way for Congress to encourage modernization, therefore, is to allow regulated providers more leeway in pricing and designing their services for large-volume users. AT&T recently gained some flexibility in this regard when the FCC tentatively approved Tariff 15 and the extension of Tariff 12.<sup>151</sup> Tariff 15, for example, permits AT&T to provide volume discounts, whereas Tariff 12 allows AT&T to customize and package a service offering to meet an individual user's needs. AT&T's competitors have strongly contested these decisions on tariffs, charging that the tariffs encourage anticompetitive behavior. Chiding the FCC for not having tried hard enough to promote competition, MCI Communications Corp. Chairman, William McGowan, stated that:

Unfortunately, those pro-competitive decisions came a relatively long time ago, and it's probably fair to ask the FCC: What have you done for competition lately? The answer is: Not a whole heck of a lot. with the Tariff 15 decision . . . the FCC seems intent upon undoing what little pro-competitive record it has.<sup>152</sup>

Some opponents are concerned, moreover, that FCC approval of these tariffs will create a precedent that will be used by RBOCs to justify similar treatment, even though they face much less competition than AT&T.<sup>153</sup>

The FCC has recently been considering these charges, although the tariffs were not suspended in the interim. In March 1989, the Commission ruled on Tariff 12, calling for revisions that would increase the availability of the offering. To date, FCC has not acted on Tariff 15.

*Option C: Extend the lines of business that regulated telephone companies can enter.*

<sup>150</sup>Ibid.

<sup>151</sup>For a discussion, see Kathleen Killete, "AT&T Seeks to Assuage Critics in Custom Network Controversy," *CommunicationsWeek*, Feb. 29, 1988, p. 10; Kathleen Killete, "Industry Group Asks FCC to Scrutinize AT&T Tariff," *CommunicationsWeek*, Feb. 8, 1988, pp. 38-39; and Kathleen Killete, "Market Limbo: How Low Can You Go," *CommunicationsWeek*, *CLOSEUP*, Aug. 15, 1988, pp. C-10, C-11.

<sup>152</sup>William McGowan, "It's Like Deja Vu All Over Again," *Telematics*, vol. 5, No. 11, November 1988, p. 17.

<sup>153</sup>Tom Valovic, "Critical User Issues: ISDN, T1 Networking, and Tariff 12," *Telecommunications*, May 1988, P. 8.

Just as economies of scale can serve to promote modernization and investment in the communication infrastructure, so **too can the** presence of economies of scope. However, whereas economies of scale depend on the volume of demand, those of scope derive from the complementarities that exist among different business activities. Thus, another way of fostering modernization might be to extend the lines of business **that** regulated telephone companies can enter.

At present, regulated telephone companies are prohibited under the Modified Final Judgment (MFJ) from engaging in three activities—manufacturing, certain aspects of information services and interexchange services, and nontelecommunication businesses.<sup>154</sup> RBOCs are also limited in their activities by the 1984 Cable Communications Act, which precludes their involvement in the provision of video services.

Viewing these restrictions **as** impediments to the development and enhancement of the U.S. communication infrastructure, policy makers in a number of different Federal Government arenas have begun to call for their relaxation or elimination. For example, the FCC, in its 1986 Computer Inquiry III, took the position that RBOCs should be allowed to offer enhanced services without structurally separate subsidiaries as long as they developed acceptable plans for opening their network architectures.<sup>155</sup> In November 1988, the FCC, after having received extensive stakeholder comments, tentatively approved the RBOCs' basic model for an open network, contingent on a number of modifications.<sup>156</sup> More recently,

FCC has opened an inquiry into whether telephone companies should be permitted to operate cable television systems.<sup>157</sup>

Similarly, the Department of Justice (DOJ), filing the first triennial report and recommendations on MFJ in February 1987,<sup>158</sup> called for a number of changes in MFJ line-of-business restrictions. In the case of interexchange services, DOJ recommended, for example, that RBOCs continue to be prohibited from providing interexchange services within their own regions, but be allowed to provide them outside of their local exchange monopolies. With respect to information services, DOJ recommended that RBOCs be allowed to provide information services, subject to FCC rules designed to protect competition and promote efficiency and innovation. In the case of telecommunication equipment, it recommended that all restrictions on manufacturing be removed.<sup>159</sup> DOJ based much of its case on the analysis done by Peter Huber in the report accompanying the recommendations, *The Geodesic Network: 1987 Report on Competition in the Telephone Industry*, which argued that new technology was leading to a network where control would be dispersed around the periphery, rather than concentrated at the center. Although acknowledging that a local exchange bottleneck still existed, DOJ claimed that, given ONA and the Joint Cost Rules, RBOCs would be deterred from using this bottleneck in an anticompetitive fashion.<sup>160</sup>

Arguing along similar lines, the National Telecommunications and Information Administration (NTIA) has also expressed strong support for removing the line-of-business restrictions. The

<sup>154</sup>The MFJ allowed for waivers from these restrictions, but left the rationale for them somewhat unclear. As one observer has described it, the lack of "coherent or consistent policy for deciding which lines of business were permissible meant that line of business waivers became a decisional quagmire." See Roger Noll and Bruce M. Owen, "United States v. AT&T: An Interim Assessment," Discussion Paper No. 139, presented to the Workshop on Applied Macroeconomics, Industrial Organization, and Regulation, Stanford University, Stanford, CA.

<sup>155</sup>Henry D. Levine, "The User's Stake in CEI and ONA," *Telematics*, vol. 3, No. 11, November 1986, pp. 3-7; see also Robert M. Frieden, "Computer III: Does FCC Theory Match Market Reality?" *Telematics*, vol. 3, No. 11, November 1986, pp. 7-14; A.M. Rutkowski, "Open Network Architectures: An Introduction," *Telecommunications*, January 1987, pp. 30-40.

<sup>156</sup>In its request for revisions, FCC required the RBOCs to make all ONA-related offerings available under Federal tariffs, and asked them to try to develop more uniform plans. Kathleen Killete, "FCC Gives Bells Partial ONA Nod," *CommunicationsWeek*, Nov. 21, 1988, p. 1; see also Charles Mason, "FCC's ONA Vote Gets Generally Favorable Reviews," *Telephony*, Nov. 28, 1988, pp. 16-17.

<sup>157</sup>FCC Docket 87-266. In so doing, the Commission suggested that the Computer III provisions might also serve as a regulatory framework under which the telephone companies could provide video services. For a discussion, see Melinda Gipson, "FCC Proposes Allowing Telcos To Provide Cable," *Cablevision*, vol. 12, No. 49, Aug. 1, 1988, pp. 12, 16.

<sup>158</sup>U.S. Department of Justice, "Report and Recommendations of the U.S. Justice Department concerning the Line of Business Restrictions Imposed on the Bell Operating Companies by the Modified Final Judgment," U.S. v. *Western Electric Co. inc. and American Telephone & Telegraph*, No. 82-0192, (D. D.C.), Feb. 2, 1987. For a discussion, see A.M. Rutkowski, "The Geodesic Network: Impact of the Huber Report," *Telecommunications*, May 1987, pp. 92, 95-97, 103.

<sup>159</sup>*Ibid.*

<sup>160</sup>See, for example, *Response of the United States to Comments on its Report and Recommendations Concerning the Line-of-Business Restrictions Imposed on the Bell Operating Companies by the Modification of the Final Judgment*, Apr. 27, 1987.

agency has taken a favorable position, for example, with respect to permitting the telephone companies to provide information services<sup>161</sup> and offer video dial tone,<sup>162</sup> as well as to enter the interexchange market.<sup>163</sup> So adamant was NTIA, in fact, that when U.S. District Court Judge Harold Greene was unreceptive to these proposals, NTIA went so far as to petition the FCC to assert its jurisdiction and, on its own, deregulate the RBOCs.

Within Congress, the impact of the line-of-business restrictions on the development and modernization of the U.S. communication infrastructure has also been of concern. As early as 1985, for example, Congressmen Swift and Tauke introduced a bill in Congress that would have rescinded the curbs on RBOCs.<sup>164</sup> More recently, 205 representatives cosponsored House Congressional Resolution 339, which—noting that it is “essential to stimulate and encourage the use of information technology by the American people” --calls for congressional action to lift the restrictions against the manufacturing of telephone equipment and the provision of information services by RBOCs, subject to regulatory safeguards.

These proposals to alter MFJ have generated an intense public policy debate, with the advocates of change focusing on the need for modernizing and developing the communication infrastructure, and the opponents concentrating on the potential for anticompetitive effects. In the case of manufacturing, RBOCs have argued that, if the manufacturing restriction is interpreted narrowly so as to preclude them from software design and development, the development and deployment of the intelligent network will be retarded. Opposing this point of view, AT&T brought the issue before Judge Greene,

charging that RBOCs’ activities in this area would be anticompetitive.<sup>165</sup> RBOCs have also argued that they could speed up the introduction of fiber to the home if they were permitted to become involved in video services. Not surprisingly, the cable companies have protested against what they perceive to be unfair competition.<sup>166</sup>

U.S. District Judge Harold H. Greene, who is responsible for administering the consent decree that led to the divestiture of the Bell System, has been against relaxing MFJ restrictions. Although, in the light of the first triennial review, Judge Greene permitted RBOCs to provide low-level gateway services, he was adamant in his refusal to let them create or manipulate the information they carry over their networks.<sup>167</sup> Nor has the Judge been willing to change the prohibitions on manufacturing, going so far as to forbid RBOCs from engaging in any form of equipment design and development.<sup>168</sup> Justifying his position, Judge Greene has noted that the consent decree requires that the restrictions on RBOCs be maintained until they can no longer use their bottlenecks for anticompetitive purposes. At present, this precondition has not yet been met. As Judge Greene has pointed out, in 1987, 99.9 percent of all long-distance traffic had to travel through local bottlenecks to get to local consumers, with only one-tenth of one percent able to bypass the regional companies.<sup>169</sup>

Judge Greene has promised to vigorously resist attacks on his authority to enforce the terms of MFJ, and has taken issue with Dennis Patrick, FCC Chairman, for allegedly “exhorting” RBOCs not to comply with the court’s orders.<sup>170</sup> Thus, barring any action on the part of Congress to change the terms of MFJ or to transfer the authority for its administration

<sup>161</sup>See U.S. Department of Commerce, National Telecommunications and Information Administration, *NTIA Telecom 2000: Charting the Course for a New Century*, NTIA Special Publication 88-21 (Washington, DC: U.S. Government Printing Office, October 1988), p. 214.

<sup>162</sup>See U.S. Department of Commerce, National Telecommunications and Information Administration, “Video Program Distribution and Cable Television: Current Policy Issues and Recommendations,” NTIA Report 88-233, July 1988.

<sup>163</sup>*Ibid.*, p. 248.

<sup>164</sup>This bill was reintroduced in 1986 and 1987.

<sup>165</sup>“AT&T Comments on the Report and Recommendations of the U.S. Justice Department,” Mar. 13, 1987.

<sup>166</sup>This issue is discussed in considerable detail in ch. 9.

<sup>167</sup>In making this concession, Judge Greene took into account the arguments having to do with modernization and the development of information services. He believed it was necessary for RBOCs to develop gateway services in order to stimulate the U.S. market for information services.

<sup>168</sup>Judge Greene feared that the removal of the manufacturing prohibition would lead to an industry “dominated by a small number of muscle bound giants, possibly dominated by foreign conglomerates.” Tim Race, “Judgment Day: Few New Freedoms for the BOCs,” *CommunicationsWeek*, Sept. 14, 1987, p. 1.

<sup>169</sup>Judge Harold H. Greene, “Day for Complete Deregulation Has Not Yet Arrived,” *Telematics*, vol. 5, No. 10, October 1988, p. 17.

<sup>170</sup>Charles Mason, “Greene Fights Back in Ruling on R&D,” *Telephony*, Dec. 7, 1987.

from the first circuit court to some other Federal agency,<sup>171</sup> the Judge's evaluation of the situation is likely to prevail.

Many others, among them a number of the RBOCs' potential competitors, agree with Judge Greene's basic assessment.<sup>173</sup> Some think that modifying MFJ is inappropriate because it represents a negotiated settlement based on interindustry compromises,<sup>173</sup> while others think that it is too soon to make alterations in it.<sup>174</sup> From the perspective of many, RBOCs not only continue to maintain control over bottleneck facilities, but they also have the ability and the incentive to engage in anticompetitive behavior through cross-subsidization and/or discrimination.<sup>175</sup> In fact, in the view of some, relaxing MFJ restrictions will increase the opportunity and incentive of the telephone companies to cross-subsidize. Moreover, many minimize the competitive impact that private branch exchanges, shared tenant networks, digital termination systems, and cellular radio services have had, or will have, on the local exchange. And some note that the role of the local exchange, and hence RBOCs' monopoly powers, may be even greater in the future when they have converted to fiber and introduced common channel signaling and ISDN.

Challenging the notion that the FCC will find it easier to monitor the operations of the telephone companies in the future, given the possibility of comparing their cost allocations and tariffs, a number of people have suggested that, with deregulation,

the FCC's job of protecting the public interest will become more, not less, difficult. Others take issue with the idea that MFJ imposes significant costs in terms of lost economies. As one economist has pointed out, the potential for economies of scale and scope are the greatest in precisely those areas where, if integration were to occur, it would be most difficult to identify anticompetitive behavior. Thus, the costs to consumers due to a lack of integration will probably be offset by the benefits they gain through enhanced competition.<sup>176</sup>

Because DOJ's recommendations assumed that the ONA process would be successfully carried out, stakeholders' reactions to RBOCs' initial ONA filings are also indicative of how they might assess the line-of-business restrictions at some later date. As CBEMA and many others pointed out in their statements to the Court, if and when ONA is effectively implemented to assure equal access, many of those who are presently opposed to altering the MFJ might look at the proposed changes in a much more favorable light.<sup>177</sup> However, in general, it can be said that RBOCs' initial filings did not allay the fears of most of those who have been opposed to relaxing the line-of-business restrictions.<sup>178</sup> One report, for example, which was commissioned on behalf of a number of companies—including ADAPSO, CBEMA, and Telenet Communications Corp.—ailed the proposals inconsistent, inadequate, and unresponsive to industry needs.<sup>179</sup> Among their complaints was that RBOCs did not go

<sup>171</sup> S.2565, a bill introduced in Congress by Senator Robert Dole in 1986, was one such attempt. If passed, it would have transferred the authority for administering the MFJ from the Court to the FCC.

<sup>172</sup> See, for examples of these comments, "AT&T Comments on the Report and Recommendations of the United States," Mar. 13, 1987; affidavit of Nina W. Cornell, *United States of America v. Western Electric Corp., Inc., and American Telephone & Telegraph*, May 22, 1987; Kenneth Baseman and Stephen Silberman, "The Economics of Bell Operating Company Diversification in the Post-Divestiture Telecommunications Industry," ICF Incorporated, September 1986; "Comments of Computer and Business Equipment Manufacturers Association," *United States of America v. Western Electric Co., Inc., and American Telephone & Telegraph Co.*, Mar. 13, 1987; and "MCI's Reply in Opposition to Motions and Recommendations to Modify the Judgment's Line of Business Restrictions," *United States of America v. Western Electric Company, Inc. & American Telephone and Telegraph Co.*, May 22, 1987.

<sup>173</sup> AT&T has argued, for example, that DOJ's recommendations compromise the agreements made at the time of divestiture. Steve Coll, "Still No Answer on American's Phones," *The Washington Post*, June 28, 1987, p. H-1.

<sup>174</sup> Opposing any proposals to lift the restrictions on the regional companies, Gene Kimmelman, legislative director of the Consumer Federation of America, has said, for example: "... the American public is still very suspicious of what happened [with the breakup of AT&T] in the first place and would prefer to let things stabilize, rather than go through a second revolution in our telephone system in five years." Ibid.

<sup>175</sup> See Cements cited above, footnote 172.

<sup>176</sup> See Cornell, op. cit., footnote 172.

<sup>177</sup> As CBEMA and many others pointed out in their statements to the Court, if and when, ONA is effectively implemented so as to assure equal access, many of those who are presently opposed to altering the Modified Final Judgment might look at the proposed changes in a much more favorable light. See CBEMA comments, op. cit., footnote 172.

<sup>178</sup> For discussion of the response, see Anne-Marie Roussel, "Bells' ONA Proposals Deemed Unacceptable," *CommunicationsWeek*, May 23, 1988, p. 42.

<sup>179</sup> Hatfield Associates, Inc., "Open Network Architecture: A Promise Not Realized," prepared for ADAPSO, CBEMA, CompuServe Inc., Dun & Bradstreet, Independent Data Communications Manufacturers Association, Inc., and Telenet Communications Corp., Apr. 4, 1988.

far enough in unbundling their services and opening up their networks.<sup>180</sup> The gap between the expectations and the outcome of this first effort to develop an ONA can be explained in part by the fact that the level of unbundling required from an antitrust perspective—and thus that would satisfy the court—is different from that called for by the FCC under Computer Inquiry III.

Not surprisingly, RBOCs have been the strongest advocates of altering MFJ. Their eagerness to enter into the lines of business that have hitherto been closed to them is clearly evidenced not only in their testimony to Congress and the court, but also by their active involvement in the ONA process, their more than 160 successful court appeals for waivers, and their growing interest in establishing joint ventures with foreign countries.<sup>181</sup>

While responding to the anticompetitive arguments made by their opponents, the RBOCs have focused much of their appeal on the issue of modernization, and on the requirement that the United States have a communication infrastructure that will allow it to compete successfully in the international arena. As John Clendenin, Chairman, BellSouth, has characterized the problem:

... my concern is how slowly that evolution takes place, and how much deep damage we do to this nation if it's not quick enough. We've heard the restrictions are causing our nation's high tech strength to atrophy—and here we've seen disturbing corroborating evidence.

This is not a special-interest concern, unless you consider America a special interest. This is a profound, broad-based concern for all American interests, large and small, telecommunications and otherwise.<sup>182</sup>

Such an infrastructure, RBOCs argue, can only be brought about if they are allowed to contribute their full measure to its development. With respect to manufacturing, they note that, if they were allowed

to become more involved in this area, they would be better able to provide timely and higher quality products and services to their customers, and that the economy would benefit from greater investment in the research and development of advanced technology.<sup>183</sup> Comparing the development of information services in the United States to that of other countries, RBOCs attribute the relatively slow rate of growth in the United States to the restrictions of MFJ. As NyNEX has described it:

It has resulted in some services being offered in an inefficient way and others not being offered at all, even though the technology to provide them, and demand for them, exist.<sup>184</sup>

Responding to the concerns of Judge Greene and others about competition, RBOCs point to how far they have gone in making equal access a reality with respect to interexchange services, CEI (Comparably Efficient Interconnection), and ONA.<sup>185</sup> In addition, they note that—given divestiture and the emergence of seven highly competitive operating companies—benchmark regulation and the Joint Cost Rules have become more feasible, thereby reducing the likelihood of cross-subsidies and discrimination. Moreover, they point out that RBOCs have a greater incentive than ever before to assure high quality, nondiscriminatory service; the more their networks are used, the more revenues they will enjoy.<sup>186</sup>

In sorting out the complicated issues raised by MFJ, it is important to consider three basic questions:<sup>187</sup>

1. Has the change in the U.S. telecommunication infrastructure since divestiture been sufficient to warrant the relaxation of RBOC restrictions?
2. What costs, if any—in terms of modernizing and developing the communication infrastructure—are entailed in making antitrust policy the linchpin of U.S. communication policy?

<sup>180</sup>*Ibid.*

<sup>181</sup>For a discussion, see Denis Gilhooly, "Unleashing the Baby Bells," *Telecommunications*, February 1988, pp. 48,57,58,60,62.

<sup>182</sup>John L. Clendenin, "The Paralysis of MFJ Analysis," *CommunicationsWeek*, Jan. 16, 1989, p. 15.

<sup>183</sup>See, for example, "Comments of Nynex Corporation on the Department of Justice's Report Concerning the Line of Business Restrictions Contained in the Modified Final Judgment," *United States of America v. Western Electric Co., Inc., and American Telephone & Telegraph Co.*, Mar. 13, 1987.

<sup>184</sup>*Ibid.*

<sup>185</sup>For one reply to the criticisms of the ONA process, see Shooshan and Jackson, Inc., *ONA: Keeping the Promise*, commissioned by Bell Atlantic, May 31, 1988.

<sup>186</sup>See, for example, Nynex comments, op. cit., footnote 183.

<sup>187</sup>For a discussion, see Robert Pepper and Stuart N. Brotman, "Restricted Monopolies or Regulated Competitors? The Case of the Bell Operating Companies," *Journal of Communication*, vol. 37, No. 1, Winter 1987, pp. 64-72.

3. What conditions, if any, might be imposed on RBOCs to limit the negative antitrust impacts of their extending their lines of business?

Any analysis of these issues is complicated by the fact that the answers to these questions may very well differ with respect to each area of business restrictions. Moreover, these questions will most likely need to be asked again and again. As Roger Noll has described the problem:

Neither the pricing issue nor the structural issue has ever been or is likely ever to be resolved. The telecommunications system is not, and never was, broke; instead, its underlying technical and eco-

nomic characteristics create an enduring policy dilemma. One can use the regulation of prices and structure for either of two ends: to encourage maximum feasible competition, or to promote an integrated monopoly. What is infeasible is a “neutral” formulaic policy regarding prices and structure that will assure the right mix of monopoly and competition. The current policy agenda is one part of the continuing futile search for better regulatory instruments, and one part rear guard actions by people who lost the last time around and who are not—and probably cannot be—convinced that the trend towards deregulated competition is the best policy.<sup>188</sup>

---

<sup>188</sup>Noll, *op. cit.*, footnote 1.

**Jurisdictional Issues in the  
Formulation and Implementation of  
National Communication Policy**



## CONTENTS

	<i>Page</i>
INTRODUCTION .....	361
THE PROBLEM .....	361
STRATEGIES AND POLICY OPTIONS.....	366

### *Figure*

<i>Figure</i>	<i>Page</i>
13-1. Congressional Strategies and Options to Address Jurisdictional Issues in Communication Policymaking .. .. .	S 368

# Jurisdictional Issues in the Formulation and Implementation of National Communication Policy

## INTRODUCTION

Rapid technological advances in the realm of communication, coupled with the unraveling of a traditional regulatory framework in the United States, have given rise to a highly uncertain communication policy environment that is endowed with both promise and problems. Occurring at a time when the role of information has become greatly enhanced, these developments will have a major impact on the lives of everyone. Each individual has an exceedingly high stake in the outcome of current communication policy debates. An exceptionally equitable, efficient, and effective policymaking process will be required to find appropriate solutions to the complex and thorny policy dilemmas that society faces, and to reconcile inevitable conflicts among competing—even if equally meritorious—interests. At the very least, the allocation of authority and the rules of the game will need to be clear and perceived to be legitimate.

## THE PROBLEM

The lack of a coherent and coordinated national process for making communication policy is likely to severely hinder efforts to develop and execute an appropriate strategy for dealing with the myriad of communication policy issues that will emerge as the United States takes its place in an increasingly global information economy. Because of the important role of federalism and the separation of powers

in the U.S. political system, the American policy process has always been somewhat disorderly.<sup>1</sup> However, as discussed here and in chapter 4, the untidiness of the policy process has been particularly noteworthy in the area of communication-inducing two Presidential policy boards to recommend the creation of a central agency to formulate overall communication policy.<sup>2</sup> OTA findings also suggest that these problems are likely to be exacerbated in the future, given a number of factors. These include:

***Factor 1: A shift in communication decision-making from the political arena to the marketplace.***

As detailed in chapter 4, there has been an overall shift in communication decisionmaking from the political arena to the marketplace during the past decade. The divestiture of the Bell Telephone System, the emergence of large users, the liberalization of many of the regulatory restrictions historically imposed on the mass media industry, and the deregulation of the cable industry are all part of this change.<sup>3</sup>

As noted in chapter 12, this shift to the private sector has had a number of positive benefits, especially when measured in economic terms. However, at the same time, it has created a vacuum in the policymaking process with respect to societal decisions about communication that are not easily made by summing up individual preferences or deferring to market power. There are a number of instances in

<sup>1</sup>For a recent analysis of the institutional barriers to effective government in the United States, see John E. Chubb and Paul E. Peterson (eds.), *Can the Government Govern?* (Washington, DC: The Brookings Institution, 1988).

<sup>2</sup>Communication policy boards established by president Truman and president Johnson both reached the same conclusion: adequate and effective communication policymaking required much greater organizational focus and coordination. Although the Office of Telecommunications Policy (OTP) was established in the Executive Office of the President (EOP) in 1970, in response to the Rostow Task Force's recommendations, it was abolished almost 8 years later as part of a plan to reduce the size of EOP. With the authority for communication now dispersed among a number of Federal agencies, it is not surprising that many observers of today's communication policy scene echo the concerns of these earlier commissions. See, for example, U.S. Department of Commerce, National Telecommunications and Information Administration, *NTIA Telecom 2000 Charting the Course for a New Century* (Washington, DC: U.S. Government Printing Office, 1988).

<sup>3</sup>For a discussion, see Eli Noam, "The Public Telecommunications Network: A Concept in Transition," *Journal of Communication*, vol. 37, No. 1, Winter 1987, pp. 30-47; see also Eli Noam, "The Future of the Public Network: From the Star to the Matrix," *Telecommunications*, March 1988, pp. 58, 60, 65, and 90; and Roger Nell, "Telecommunications Regulation in the 1990s," Publication No. 140, Center For Economic Policy Research, Stanford University, Stanford, CA, August 1988.

which private choices, as registered in the marketplace, may not lead to an optimal social outcome—whether it be with respect to the security/survivability, interoperability, or modernization of the communication infrastructure, or access to it. In fact, as the cases of standards-setting and open network architecture (ONA) would suggest, it may be precisely because of the enhanced role of the marketplace that the Federal Government is called on in the future to play an even more active role in establishing and reconciling communication policy.

**Factor 2: Intensification of jurisdictional conflicts among traditional decisionmaking authorities.**

Where power and authority are widely dispersed, as they are in the U.S. communication system, effective policymaking and implementation require that goals be clearly understood and agreed upon. Moreover, key decisionmaking roles will need to be clearly defined and generally well accepted. Otherwise, jurisdictional disputes will emerge, paralyzing the entire decisionmaking process. In chapter 8, OTA identified a number of reasons these prerequisites for effective policymaking are likely to be lacking in the future. These include:

**The failure of either Congress or the executive branch to reconsider and reestablish U.S. communication policy to take into account the major technological, structural, and regulatory changes now taking place in society.**

The problems entailed in national goal-setting have already been referred to above. How the failure to set communication goals might precipitate jurisdictional disputes that paralyze decisionmaking is clearly evident, for example, in the dispute between U.S. District Court Judge Harold Greene and the Federal Communications Commission (FCC) concerning line-of-business restrictions (discussed in ch. 12). As Judge Greene has noted on a number of occasions, it is in the absence of a congressionally

mandated alternative that the Frost district court has taken to establishing the Nation's communication policy.<sup>4</sup>

**The continued convergence of communication, information, and video technologies.**

In the United States, decisionmaking and regulatory authority has generally been distributed on a technology-by-technology basis.<sup>5</sup> In the past—whether in congressional committees or executive branch agencies, or between Federal, State, and local entities—there has generally been a clear line of demarcation between those responsible for telephony and those responsible for mass media. With the convergence of communication, information, and video technologies, however, the boundaries among jurisdictions are becoming increasingly blurred, giving rise to a growing number of interagency and intergovernmental disputes.

One potential area of dispute, for example, is that of video distribution. If telephone companies were permitted to distribute video services, along with cable companies and broadcast networks, the cable companies could be subject to municipal franchise agreements, telephone companies could be regulated at the State level, and the networks could be regulated at the national level. To the extent that policy goals vary according to jurisdiction, as they appear to now, it may be increasingly difficult to establish a coherent national policy for video.

**A growing divergence of interests between the States and the Federal Government.**

The Communications Act of 1934 is somewhat ambiguous in allocating responsibility for communication policy between the States and the Federal Government.<sup>6</sup> According to the act, FCC has the authority to regulate the interstate portion of the telecommunication industry, as well as the intrastate portion to the extent that it significantly affects FCC's intrastate policy. The States are assigned

<sup>4</sup>See, for instance, Linda M. Buckley, "Judge Greene Blasts DOJ for Lax MFJ Enforcement," *Telephony*, June 1, 1987, p. 12; see also Charles Mason, "Greene Fights Back in Ruling on R&D," *Telephony*, Dec. 7, 1987, p. 3; and Kathleen Killete, "Judge Greene Chides DOJ," *CommunicationsWeek*, Aug. 15, 1988, p. 38.

<sup>5</sup>For a history of this development, see Ithiel de Sola Pool, *Technologies of Freedom* (Cambridge, MA: The Belknap Press of Harvard University Press, 1983).

<sup>6</sup>For a discussion, see Nell, *Op. Cit.*, footnote 3, pp. 5-7.

responsibility for regulating everything else.<sup>7</sup> Because it is difficult to separate the telephone network into interstate and intrastate pieces, the potential for jurisdictional issues to emerge between the States and the Federal Government has always been inherent in the overall institutional structure.<sup>8</sup> As described by Roger Nell:

... a practical limit to the FCC's jurisdiction undoubtedly exists, but its location is uncertain, and subject to swings in the reigning political philosophy of the DOJ [Department of Justice], the FCC, and the federal courts. Indeed, the jurisdictional boundary between state and federal regulation is arbitrary, uncertain, and subject to random changes. As a result, federal-state conflicts are not only inevitable, but perpetual, for a loss by one side today does not assure a loss tomorrow on a similar issue.<sup>9</sup>

Where jurisdictional issues emerged in the past, the Courts, until quite recently, have generally ruled in favor of the Federal Government.<sup>10</sup> So long as the States and the Federal Government were in basic agreement, about both underlying communication policy goals and the most appropriate mechanisms for achieving them, the division of responsibility proved to be manageable if, at times, quite cumbersome.

With deregulation and divestiture, however, there has been a growing divergence of interests between the States and the Federal Government as well as among the States themselves. In the absence of a strong Federal role, the States have found themselves in a position to have far greater influence on telecommunication policy than ever before. Moreover, faced with varying kinds of problems and circumstances, they have moved in several different directions.<sup>11</sup> For example, Nebraska has approved a bill that would further decrease the public service commission's control over rates. Vermont has approved a form of "social contract" that will keep local rates down while allowing substantial freedom for the local telephone company in the more competitive services. Florida works with "equal access exchange areas" rather than local access and transport areas (LATAs), and allows banded rates for carriers. Illinois has moved aggressively to eliminate almost all forms of cross-subsidies and to transfer access costs to end-users. And California has instituted a comprehensive Lifeline program for low-income subscribers, and is developing some innovative approaches for dealing with transactions between Pacific Telesis and its affiliates.

This divergence among State policies, while allowing the States to serve as laboratories (much as

---

<sup>7</sup>Public utility regulation began at the State level 80 years ago. New York, Wisconsin, Illinois, and New Jersey were among the first States pushed by an odd alliance of progressive politicians and industry interests to establish independent regulatory bodies. Politicians defended these agencies as necessary to prevent the new "home-intruding" natural monopolies—such as telephones, electricity, and water service—from abusing the "public interest." Public utility commissions (PUCs; in some States called public service commissions, commerce commissions, corporation commissions, or public utility boards) evolved to focus on intrastate telephone service, while the Federal Communications Commission (FCC) regulated interstate telephone, telegraph, and mail service. Paul Teske, "State Regulation of Telecommunications," OTA contractor report, July 6, 1987.

<sup>8</sup>As Nell has pointed out: "The difficulty created by these jurisdictional separations is that they presume the existence of distinct federal and State services. But the telecommunications network is an integrated system. Very little of it is used exclusively to provide strictly intrastate services. As a result the FCC and state regulators often find themselves regulating the same thing. In all network industries jurisdictional separations are artificial and arbitrary to some degree, but these distinctions make the least sense in telecommunications." *Op. cit.*, footnote 3, p. 6.

<sup>9</sup>*Ibid.*, p. 7.

<sup>10</sup>One of the first preemption cases arose from the FCC's *Carterfone* decision in 1968. Since then, as noted by Andrew D. Lipman: "The FCC subsequently proceeded to preempt state regulation of DTS [digital termination systems], enhanced services, mobile radio, SMATV [satellite master antenna television], satellite antennas, certain aspects of inside wire, broadcast subcarriers and physically intrastate WATS [wide area telephone service] when used to originate terminate interstate calls. The FCC has been particularly prone to pre-empt in cases in which states have erected barriers that preclude new entrants from providing federally approved communication services, or when the FCC finds that state regulation would impair or prevent the provision of interstate services in contravention of national policies favoring development of nationwide communications services." Andrew D. Lipman, "Sparks Continue to Fly Over Pre-emption Issue," *Telephony*, Aug. 4, 1986. In 1986, however, the tide in favor of the FCC appeared to be stemmed when the Supreme Court's *Louisiana Public Service Commission v. FCC* (54 U.S.L.W. 4505) decision prevented FCC pre-emption of intrastate depreciation practices. For a discussion, see Joseph R. Fogerty and H. Russell Frisby Jr., "Supreme Court Decision Upends State-Federal Regulatory Balance," *Telephony*, July 14, 1986, pp. 102, 106, 110-111.

<sup>11</sup>Institutional responsibility also varies greatly across States. PUCs hold quasi-judicial power, and their decisions are subject to judicial review. In some States, such as Virginia, the PUC assumes almost all regulatory functions, including insurance, banking, corporate charters, and professional licensing. In other States, like New Mexico, the PUC performs far more limited regulatory functions, in only a few instances. The original enabling statutes were passed in a period of transition from competition to consolidation, and they generally empowered PUCs to establish franchises and to balance ratepayer interests versus company finances. Universal service is generally not an explicit goal, although it has evolved into an important objective. No deregulatory, efficiency, or economic-development goals are typically specified in these laws.

James Madison had originally envisioned), has also made it difficult for FCC to implement its deregulatory policy agenda and to move forward in developing ONA. A number of States have taken steps to shield their local exchange companies from competition, and many have strongly opposed the idea of adopting alternatives to rate-of-return regulation.<sup>12</sup> Characterizing the different State perspectives with respect to deregulation, Roger Nell has pointed out, for example, that:

One group regards the entire federally-inspired move towards competition as a major mistake, and yearns for the reestablishment of vertically integrated monopoly with a federal-state regulatory partnership. This group tends to be motivated primarily by a desire to protect universally available, low price basic local service, and to believe that this characteristic of telephone service is precarious. Another group of state regulators adheres more closely to the FCC-NTIA [National Telecommunications and Information Administration] view. They tend to foresee a future in which most of what remains of regulation is confined to local service, and in which the dominant regulatory role is held by the states.

A third, small group of state regulators seeks to extend the logic of the antitrust decree to its ultimate implication at the state level: to permit competition everywhere, with the hope of eventually deregulating the BOCs [regional Bell operating companies] in order to eliminate the perverse incentives of regulated monopoly.<sup>13</sup>

There is little reason to expect that Federal and State interests will be more closely aligned in the future. Divestiture, plus inflationary pressure on local rates in the 4 years prior to AT&T's breakup,

changed the level of interest and importance for State telecommunication regulation. And it appears that the States plan to remain quite firm in protecting their interests throughout the ONA process, especially with respect to pricing.<sup>14</sup> Five States—California, Florida, Maine, Minnesota, and New York—have already adopted their own ONA plans, parts of which are in conflict with FCC-approved plans. The States, moreover, are likely to be quite successful in exerting their influence because, although FCC has been guiding the ONA process, most ONA services will be provided in the States' jurisdictions.<sup>15</sup> As Peter Ciccone, Vice president-Finance and Controller, New York Telephone, has laid out the dilemma facing policymakers:

Is the FCC going to dictate that if one jurisdiction is offering BSEs [basic service elements] and they're technically feasible, that all should offer them, despite what states want; is the FCC going to dictate that they be deployed?<sup>16</sup>

Also steering the States in diverse directions is the fact that many State officials are now beginning to recognize the economic development potential of telecommunication. While different costs and facilities have not yet proven to be major factors in business-location decisions, some large users feel that they are increasingly important.<sup>17</sup> As noted by T. Travers Waltrip, of the Travelers Insurance Co., for example:

Every time we build a new site, which means we're hiring people in an area, increasingly one of our highest concerns is the telecommunication facility feeding the property. Dropping down on our

<sup>12</sup>For a discussion, see Roger G. Nell and Bruce M. Owen, "United States v. AT&T: An Interim Assessment," Discussion paper No. 139, Workshop on Applied Macroeconomics, Industrial Organization, and Regulation, Stanford University, June 1987. As Nell and Owen have noted: "Most states do not beat around the bush; they simply outlaw intraLATA competition. As of January 1987, only fourteen of the fifty-one states (including D. C.) allowed facilities-based intraLATA competition, and of these, three effectively prohibit competition by imposing a 'block or pay' rule, and several others restrict the extent of permissible competition or simply have failed to license any competitors." *Ibid.*, p. 18.

<sup>13</sup>Noll, *op. cit.*, footnote 3, pp. 5-6.

<sup>14</sup>See Eli M. Noam, "Implementing ONA: Federal-State Partnership Needed to Connect Network of Networks," *CommunicationsWeek*, May 2, 1988, p. 15, and Eli M. Noam, "IKSEs? BSA? Federal-State Teamwork is Key to Juggling ONA Issues," *CommunicationsWeek*, May 9, 1988, pp. 17, 48; and Eli M. Noam, "States, Feds in New Battle," *CommunicationsWeek*, May 2, 1988, p. 12. For other views of State regulators, see Robert Entman, *State Telecommunications Regulation: Developing Consensus and Illuminating Conflicts*, Report of an Aspen Institute Conference, July 30-Aug. 3, 1988. See also previous discussion of price caps in chs. 9 and 12.

<sup>15</sup>According to Gerald Bork, Chief of the FCC's Common Carrier Bureau, for example: "[T]he Commission recognizes that some BSEs [basic service elements] would be basic services tariffed at the state level, and has acknowledged the states' authority over the rates, terms, and conditions of intrastate basic-service offerings used in ONA. The commission, of course, does not set rates for BSEs that are in the states' jurisdiction." As cited in Entman, *op. cit.*, footnote 14, p. 31, from a statement before the Senate Subcommittee on Communications, July 14, 1988.

<sup>16</sup>As cited in Entman, *op. cit.*, footnote 14, p. 30.

<sup>17</sup>Teske, *op. cit.*, footnote 7, p. 3.

list of priorities are such things as salary levels and real estate prices.<sup>18</sup>

Increasingly, States are taking these concerns into account. In an effort to meet the needs of large users, the State of Nebraska, for example, passed legislation in 1987 that provides for radical price deregulation of all services, including local service. Although Nebraska is a low-population State with no particular tradition of innovation in telecommunication, its political leaders decided that Nebraska had to take some dramatic action if it was to attract high-technology, telecommunication-dependent firms as called for in its economic development plan. As former Governor John Kerry explained:

If you live in a rural isolated state like Nebraska, you absolutely need to be connected to the rest of the country. And there is technology coming along that can connect us much more closely. But to get it, we have to move away from arguing, "What should the price of the product be?" and into, "What should the product be?"<sup>19</sup>

Concerned about the loss of jobs and businesses to neighboring areas, New York State has also focused on the economic development aspects of communication policy. Recently, for example, the New York Public Service Commission has taken under consideration the question of whether or not New York City will be in danger of losing a competitive edge if it fails to push for an integrated services digital network (ISDN).<sup>20</sup>

If State regulators continue to view communication policy in this light, it will be increasingly difficult to construct a national policy that mutually satisfies all of their needs.

### ***Factor 3: Increasing linkages among communication policies and other socioeconomic policies.***

Because communication is both an end in itself and a means to accomplish other societal ends, communication policy has, to some extent, always been linked to a number of socioeconomic policies. However, in all realms of human endeavor, the strategic role that communication and information

will play in the future is likely to be greater than ever before (see chs. 5 through 8). Therefore, it is likely that communication policy will become more and more connected to policies in other areas.

The relationship between communication and economic development has already been mentioned. A similar convergence is also occurring between communication and trade policy. Acknowledging the special role that communication and communication technologies now play in economic growth and development, the 1988 Trade Bill, for example, singles out the telecommunication sector for special attention. OTA's analysis identifies other policy areas that may also be affected in the future. For example, how communication opportunities are realized and distributed in the political realm will depend as much on policies for campaign financing and national security as on communication policy per se (see ch. 6). Similarly, if individuals and businesses are to reap the potential benefits of new technologies, significant changes in U.S. education and information policy may be required (see chs. 5 and 8).

### ***Factor 4: Increased interdependence of national and international communication policies.***

As economies become linked across national boundaries, so do the communication systems that undergird them. And communication policymaking in one country becomes increasingly dependent on the policies adopted in others. Resolving intergovernmental differences will require much greater participation in international decisionmaking fora. Thus, as the U.S. economy becomes more integrated with other national economies, communication policymakers will increasingly have to factor in a much greater number and variety of international variables when making domestic policy decisions.

International events, for example, impelled FCC to take greater initiative in prodding the U.S. high definition television (HDTV) standards-setting process. Similarly, the growing international acceptance of open systems interconnection (OSI) stan-

<sup>18</sup>As cited in Mark Nadel, "The Changing Mission of Telecommunications Regulators at the State Level," Aspen Institute Conference, August 1986, p. 5.

<sup>19</sup>T.R. Reid, "Phone Deregulation, Phase 2," *The Washington Post*, May 27, 1986, p. A-1.

<sup>20</sup>See John Foley, "New York Probes ISDN," *CommunicationsWeek*, Sept. 26, 1988, p. 1.

dards was one of the reasons the Department of Defense renounced the Transmission Control Protocol/Internet Protocol (TCP/IP) in favor of OSI.<sup>21</sup> This growing interdependence of national communication policies was, of course, most strikingly illustrated at the recent World Administrative Telephone and Telegraph Conference (WATTC) meeting in Melbourne, Australia, where arriving at an international consensus required all governments to make significant compromises.<sup>22</sup>

These kinds of interdependencies compound the problems of communication policymaking in the United States. Although all agencies now have to be more cognizant of international developments, the fragmented nature of the agencies means that no one agency is equipped to fully present a coherent and clear-cut U.S. communication policy perspective. Under these circumstances, it is not surprising that jurisdictional disputes abound among decisionmakers.<sup>23</sup> Cementing on this problem, NTIA Telecom 2000 notes, for example:

The Secretaries of Commerce and State and U.S. Trade Representative are legally required to coordinate their efforts with other agencies, but there is no specified mechanism to ensure that this will occur. Unfortunately, accomplishing such coordination is difficult when faced with disputes among agencies, competing demands for high-level attention, time pressures, and often inadequate resources.<sup>24</sup>

Because of the growing importance of telecommunication to trade, FCC recently raised again the prospect of becoming more involved in trade policy issues. Its proposal, however, was not well received by agencies such as the U.S. Trade Representative and the Department of State, which traditionally have authority in this area.<sup>25</sup>

### ***Factor 5: Emergence of large users as key players in communication decisionmaking.***

Also contributing to the confused state of communication decisionmaking in the United States is the emergence of large users as key players. Eager to employ new technologies strategically, a number of them have been unwilling to await decisions in the public policy arena. Acting outside of the formal public policymaking process, they have taken steps to create and structure their own private communication infrastructures.

For example, in the area of standards, large users are becoming particularly effective in defining their own communication environments and in sidestepping the traditional policymaking process, as seen in the development and establishment of the Manufacturing Automation Protocol (MAP) and Technical and Office Protocol (TOP). It is understandable that users are taking more and more initiative in this area, given the slow pace of the formal standards-setting process. For instance, the establishment of the X.25 standard for packet-switching—reputed to be one of the most rapidly adopted standards—took approximately 4 years. Nevertheless, the actions of large users in the area of standards can have significant public policy implications, and thus can compound the problems of developing a consistent and coherent national communication policy.

## **STRATEGIES AND POLICY OPTIONS**

Organizational arrangements are not neutral; they define power relationships determining who will

<sup>21</sup>Martin Edmonds, "Defense Interests and United States Policy for Telecommunications," OTA contractor report, June 30, 1988.

<sup>22</sup>For discussions of this meeting, see Albert Halprin, "WATTC-88 offers a Grand Opportunity," *CommunicationsWeek*, Sept. 12, 1988, p. 16; Dennis Gilhooly, "U.S. 'Isolated' at World Conference," *CommunicationsWeek*, Dec. 5, 1988, p. 17; G. Russell Pipe, "WATTC Agrees on New Telecom Rules," *Telecommunications*, January 1989, pp. 119-21; and R.E. Butler, "The Why and Whereto of WATTC-88: The Benefits of Global Agreement," *international Computer Law Advisor*, vol. 3, No. 2, November 1988, pp. 8-11.

<sup>23</sup>NTIA called attention to this issue in 1983 when it submitted a study on the subject to the Senate Subcommittee on Communications. For a discussion, see B.W. Rein et al., "Implementation of a U.S. 'Free Entry' Initiative for Transatlantic Satellite Facilities: Problems, Pitfalls, and Possibilities," *George Washington Journal of International Law and Economics*, vol. 18, No. 459, 1985, pp. 523-524.

<sup>24</sup>NTIA, *op. cit.*, footnote 2, p. 179.

<sup>25</sup>For a discussion, see Andrew D. Lipman, "The FCC Jumps Into Foreign Trade Debate," *Telephony*, Apr. 16, 1987, pp. 62-63. The relationship among these agencies is governed by Executive Order 12045, but as Henry Geller has noted, the order "is so vaguely worded that it simply does not settle conflicts or provide guidance of issues of coordination." Henry Geller, "The Federal Structure for Telecommunications Policy," paper no. 8, *The Benton Foundation, Policy Options Project*, Washington, D. C., 1989.

control what, and for what ends.<sup>26</sup> Thus, strategies designed to address jurisdictional issues and problems of policy coordination generally require organizational change. Because organizations are inherently political, their creation or restructuring can serve to express national commitment, influence program direction, and order priorities.<sup>27</sup> More often than not, an organization's specific structure and the form it takes will reflect the political climate in which it emerges, rather than the current principles of public administration.<sup>28</sup>

To address the problems identified above, Congress can pursue any of four basic strategies. It could:

1. take the lead in establishing communication policy priorities and in allocating organizational responsibilities accordingly;
2. establish an ongoing organizational mechanism, outside of Congress, to resolve policy inconsistencies and jurisdictional disputes;
3. provide an interagency and/or interjurisdictional mechanism for coordinating communication policy and resolving jurisdictional issues; and
4. establish an institutional basis for facilitating coordination and cooperation among government agencies, industry providers, and communication users.

These strategies, and potential options for pursuing them, are discussed below and summarized in figure 13-1.

***Strategy 1: Take the lead in establishing communication policy priorities and in allocating organizational responsibilities accordingly.***

*Option A: Reassess and redefine national communication policy goals, revising the Communications Act of 1934 where appropriate.*

This option has already been discussed in chapter 12 in conjunction with the issue of modernization. It should be emphasized here, however, that many jurisdictional issues stem from the fact that the Communications Act of 1934 has not been updated to take account of a greatly changed technological and socioeconomic environment.

Because the structure of organizations reflects their basic goals, any significant rewriting of the Communications Act will also entail considerable organizational change. In particular, if Congress decides to press for a national communication policy, it will need to rethink and perhaps restructure the roles and relationships between the States and the Federal Government with respect to establishing and implementing communication policy. Government agencies will also be affected, since the choice of lead organizations will be governed by the priorities placed on different goals. Changes of such magnitude are likely to be strongly resisted by present stakeholders if steps are not taken to build a broad, national consensus in support of new policy goals, and if roles and responsibilities appear to be unfairly and/or inappropriately allocated.

*Option B: Establish a national commission to evaluate the changed communication environment and recommend to Congress appropriate policy changes and steps that need to be taken to implement them.*

Another way that Congress might try to reconcile competing communication policy goals and issues would be to establish a national commission to evaluate changes in the communication environ-

<sup>26</sup>For a discussion, see Harold Seidman, *Politics, Position, and Power: The Dynamics of Federal Organization* (New York, NY: Oxford University Press, 3rd ed., 1980), p. 15; see also Dwight Waldo, *The Administrative State* (New York, NY: The Ronald Press, 1948), chs. 10 and 11.

<sup>27</sup>*Ibid.* See also Harvey C. Mansfield, "Reorganizing the Federal Executive Branch: The Limits of Institutionalization," *Law and Contemporary Problems*, vol. 35, Summer 1970, p. 462.

<sup>28</sup>Herbert Simon, Donald W. Smithburg, and Victor A. Thompson, "How Government Organizations Originate," *Public Administration* (New York, NY: Alfred A. Knopf, 1950).

As identified by Ira Sharkansky, there are four intellectual roots that, in this country, provide a public administration rationale. They are: "1) the desire to maintain political accountability in public administration; 2) the desire to maintain the traditional equilibrium among the three constitutional branches of government by preserving the separation of powers and checks and balances; 3) the desire to insure that professional and technical skills are brought to bear on relevant matters of policy formulation and implementation; and 4) the desire to maximize the efficient use of resources by means of a hierarchical form of organization." See Ira Sharkansky, "Administrative Organization and Control Units: Structures and Their Intellectual Roots," in *Public Administration: Policy-Making in Government Agencies* (Chicago, IL: Rand McNally College Publishing Co., 3rd ed.), ch. 4.



**Figure 13-1-Congressional Strategies and Options to Address Jurisdictional Issues in Communication Policymaking**

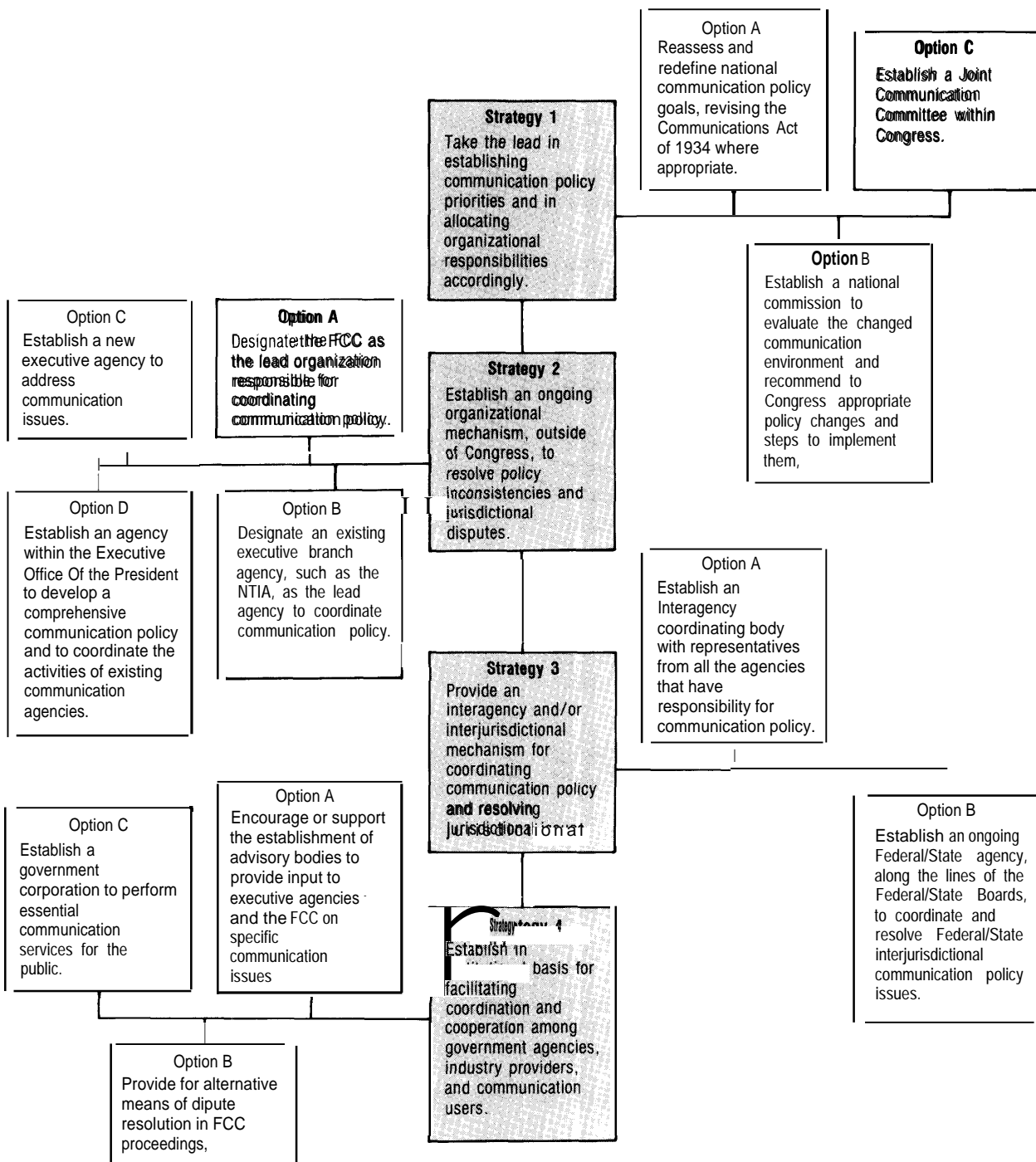

ment and recommend appropriate policy and organizational changes. In the past, national commissions have been especially useful in focusing the Nation's attention on issues of great magnitude that are likely to have a broad impact on everyone, such as those the United States is currently facing in the area of communication.<sup>29</sup> Because national commissions are generally established to deal with a specific set of problems and have a limited tenure, the risk of generating an enduring, eventually unnecessary, government bureaucracy is small. Moreover, because they are temporary and unique in nature, commissions can often attract the assistance of outstanding individuals with broad experience who would not be available on a long-term basis. By heightening the public's awareness of a problem, and by engaging the public to debate its solution, commissions can also serve an important legitimating function that can be particularly useful in times of major change.<sup>30</sup>

Establishing a national commission to focus on a national communication policy might be particularly appropriate today, given the size and scope of the technological and socioeconomic changes taking place, the new communication players entering the scene, and the changing roles of traditional players. However, setting up such a commission means that valuable time is lost in the continued study of the problem.<sup>31</sup> Concerned about the ability of the United States to compete, some would argue that, as a society, we don't have this time to lose. Commissions have also been known to diffuse public energy and concern, as many have been purposely designed to do.<sup>32</sup>

#### *Option C: Establish a Joint Communication Committee within Congress.*

Congress has often been criticized for its inability to deal with long-term, global issues.<sup>33</sup> The Commission on Operation of the Senate, for example, found that "the legislative process as it presently

operates appears to be organized primarily for incremental decisionmaking rather than addressing major problems in a comprehensive manner."<sup>34</sup> To some extent, therefore, the organizational structure of Congress, as it presently exists, may inhibit its ability to treat communication policy as a broad-based, societal issue.

One step Congress might take is to establish a joint committee within Congress to address communication policy from the broadest possible perspective. Provision might be made, for example, to assure the participation of representatives from other committees whose past interest and involvement have been only tangential to communication policy, but whose present concerns are becoming more and more linked. At present, Congress has four joint committees-Economic, Taxation, Printing, and the Library. These committees have no legislative jurisdiction; they are established primarily for purposes of study and coordination.

The major functions of a joint communication committee might be to:

- coordinate the formulation of congressional communication policy;
- maintain a professional staff with broad expertise in, and a broad view of, communication policy;
- monitor technological and market changes in domestic and international communication; and
- coordinate the participation of other congressional committees,

Such a joint committee might not only provide for coordination within Congress; to the extent that agency and stakeholder representatives direct their lobbying activities toward the joint committee, it would also serve as a point of coordination for many other groups.

<sup>29</sup>For one discussion of the role of commissions, see Frank Popper, *The President's Commission*, Twentieth Century Fund, April 1970.

<sup>30</sup>For a discussion, see Seidman, *op. cit.*, footnote 26, pp. 23-25.

<sup>31</sup>NTIA makes this case, for example. See NTIA, *op. cit.*, footnote 2, p. 177.

<sup>32</sup>*Ibid.*

<sup>33</sup>For a discussion, see Ernest Gellhorn, "The Congress," ch. 13, Glen O. Robinson (ed.), *Communications for Tomorrow: Policy Perspectives for the 1980s* (New York, NY: Praeger, 1978),

<sup>34</sup>U.S. Congress, Senate Committee on Government Operations, Subcommittee on National Policy Machinery, "Organizing for National Security," vol. 3, Staff Report and Recommendations, 1961, p. 7.

Although establishing a joint communication committee should not be difficult in theory, in accordance with the rules of Congress, its creation would likely be strongly resisted in practice. A number of committees in both the House and Senate are concerned with communication issues, representing a broad range of expertise. Their members would be bound to oppose any efforts that might circumscribe their power or authority. Although they do not have the same resources to resist such a reorganization, many stakeholders would also be against it. They have already established their ties and built their alliances within the existing committee and subcommittee structure.

**Strategy 2: Establish an ongoing organizational mechanism, outside of Congress, to resolve policy inconsistencies and jurisdictional disputes.**

To the extent that the current changes constitute part of a continuum that is likely to extend considerably into the future, it is unlikely that a one-time adjustment will suffice, even with major revisions to the Communications Act.<sup>35</sup> Instead, what may be required to handle these changes is the designation of a permanent, ongoing organization to resolve communication policy conflicts and jurisdictional disputes. Such an organization might take any of a number of forms, depending on what emphasis is preferred in a national communication policy.

In considering these options, it should be remembered, however, that organizational change is not a panacea and cannot substitute for policy agreement. As Seidman has noted:

The quest for coordination is in many respects the twentieth century equivalent of the medieval search for the philosopher's stone. If only we can find the right formula for coordination, we can reconcile the irreconcilable, harmonize compelling and wholly divergent interests, overcome irrationalities in our

government structure, and make hard policy choices to which no one will dissent.<sup>36</sup>

Because of the connection between organizational structure and policy orientation, stakeholder preferences concerning where the organizational responsibility for coordinating communication policy should lie are often colored more by their policy preferences than their views about public administration. As described by one authority on public administration policy:

As a rule, however, reorganization proposals have as their objective the furtherance of some public policy. Indeed, reorganization appears to be a basic political process through which individuals and groups gain power and influence over others in order to achieve the social and political change they consider desirable.<sup>37</sup>

A recent example of this phenomenon is the Dole Bill, which would have transferred the responsibility for administering the Modified Final Judgment (MFJ) from the district court to the FCC. Although the merits of the bill were argued on the basis of organizational criteria, lobbying on the bill correlated highly with stakeholders' attitudes towards liberalizing MFJ. Those in favor of liberalization supported the Dole Bill, and those opposed argued that the court should retain responsibility for MFJ.<sup>38</sup>

*Option A: Congress could designate the FCC as the lead organization responsible for coordinating communication policy.*

Established by the Communications Act of 1934, FCC was designed, in part, to implement the act "by centralizing authority heretofore granted by law to several agencies."<sup>39</sup> However, the mushrooming of other agencies and authorities to deal with burgeoning communication and communication-related issues has seriously challenged FCC's role in this regard.<sup>40</sup>

<sup>35</sup>For a discussion of the difficulties entailed in applying short-term solutions to long-term problems, see Seidman, OP. cit., footnote 26.

<sup>36</sup>Ibid., p. 205.

<sup>37</sup>Ronald Moe, "Executive Branch Reorganization: An Overview," Library of Congress, Congressional Research Service, 1978, p. 6.

<sup>38</sup>U.S. Congress, Senate Committee on Commerce, Science, and Transportation, *Federal Telecommunications Policy Act of 1986, hearings*, 99th Cong., 2d. sess., on S. 2565 (Washington, DC: U.S. Government Printing Office, 1986)

<sup>39</sup>47 U.S.C.151.

<sup>40</sup>For discussions of some of the problems recently faced by the FCC, see Kathleen Killete, "Patrick: The Steadfast Believer In FCC's Ability to Guide Telecom," *CommunicationsWeek*, Nov. 16, 1987, pp. 8, 21; Sam Dixon, "Observers Disagree on FCC's Success Rate in D.C. Circuit," *Telematics*, April 1988, vol. 5, No. 4, pp. 1-4; Kathleen Killete, "House Grills FCC on Regulation Plans," *CommunicationsWeek*, Nov. 16, 1987, p. 8.

Created as an independent agency, FCC is organizationally linked and ultimately responsible to the legislative branch rather than to the executive.<sup>41</sup> And, since it is the job of the legislature to make policy (in theory at least), it can reasonably be argued that FCC should be assigned the task of reconciling national communication policy objectives and jurisdictional disputes on a day-to-day basis. This legislative connection might also serve to assure that, when developing communication policy, a broad range of interests is taken into account. Because compromise is inherent in the congressional environment, the legislative perspective is often eclectic and inclusive of many minority points of view.

This tendency to be all-embracing, however, is both a strength and a weakness of the FCC option. As seen in the Reagan Administration's pursuit of its deregulatory agenda, the congressional focus on winning political favor and fashioning political compromises can serve to put the brakes on any major policy departure.<sup>42</sup>

Some might also take issue with the option of transferring considerable policymaking authority to FCC on grounds of democratic theory, which requires that policy organizations be held directly accountable to the public for their actions.<sup>43</sup> Although shifting this authority to FCC would certainly not shield the policymaking process from public influence, it might change the nature and

process of the debate about policy issues. As Glen Robinson has noted in this regard:

In the FCC, as in Congress, results depend on organized, sustained and concentrated efforts by interested persons. Not surprisingly, this gives private industry groups a decided advantage vis-a-vis less organized groups purporting to represent the interests of the general public.<sup>44</sup>

Furthermore, as in the case of the Dole Bill, any proposal to focus policy coordination within FCC is likely to be strongly resisted by those who-by virtue of their *own* positions within the administrative bureaucracy or because of their own policy preferences—would stand to lose.<sup>45</sup> This option would certainly be opposed by NTIA which, as noted below, sees itself as a more appropriate locale for policy coordination. In its 1988, *NTIA Telecom 2000*, NTIA argued, in fact, that the executive branch should, at the very least:

... have the ability to disapprove FCC action, at least in matters of overriding national security, foreign policy, international trade, or economic Policy.<sup>46</sup>

In addition, others who have been highly critical of FCC's recent performance would also oppose any extension of its present responsibilities.<sup>47</sup>

If FCC were assigned an enhanced role in developing and coordinating national communication policy, it would clearly need much greater resources.<sup>48</sup> Also, the composition of FCC staff

<sup>41</sup>Although independent regulatory agencies have traditionally performed a combination of legislative, administrative, and judicial functions—and, in fact, this was one of the original justifications for their existence—they are, in theory, regarded as “arms of the Congress.” For a general discussion of independent regulatory agencies, see U.S. Congress, Senate Committee on Governmental Affairs, *Study on Federal Regulation*, vol. V, *Regulatory Organization, prepared* Pursuant to S. Res. 71, (Washington, DC: U.S. Government Printing Office, December 1977).

<sup>42</sup>As Glen Robinson has pointed out, this tendency of Congress to be conservative is considered by some to be a benefit. As he notes: “For landbound conservatives . . . Congress’ incapacities are more a virtue than a vice; they discourage facile legislative solutions to social and economic problems—solutions that often prove short-sighted and ultimately mischievous.” Robinson (cd.), op. cit., footnote 33, p. 358.

<sup>43</sup>For this point of view, see Robert G. Dixon, Jr., “The Independent Commissions and Political Responsibility,” *Administrative Law Review*, vol. 25, No. 1, Winter 1975, pp. 1-16.

<sup>44</sup>Robinson (cd.), op. cit., footnote 33, pp. 356-357.

<sup>45</sup>For example, there was considerable opposition, especially from the Departments of Commerce and State, to the recent proposal to authorize the FCC to take on more responsibility for dealing with international issues.

<sup>46</sup>NTIA, op. cit., footnote 2, P. 20.

<sup>47</sup>See, for instance, Henry Geller, op. cit., footnote 25, p. 15. As Geller notes: “The FCC’s failure to develop objective, effective policies has been well documented. The agency delayed cellular radio service for a decade, and still has no objective policy to deal with broadcast license renewal. In regard to the comparative renewal of broadcast licenses, the FCC’s policies are ‘mush’ and much criticized by the courts. The FCC issued a notice on comparative renewals in 1981, a further notice in 1982, and a still further notice in 1988.” See also Henry Geller, “Communications Law—A Half Century Later,” *Federal Communications Law Journal*, vol. 37, 1985, p. 73.

<sup>48</sup>For a discussion of limited resources, see Glen O. Robinson, “The Federal Communications Commission,” Robinson (ed.), op. cit., footnote 33, pp. 382-388. It should also be noted that the FCC’s limited resources for regulating the entire Bell System were one of the rationales for divestiture.

would probably need to be expanded. As Seidman has pointed out, government agencies are social institutions that take on characteristics, or even personalities, of their own:

Each profession seems to mold and shape the decisionmaking process so that issues will be presented and resolved in accordance with its professional standards.<sup>49</sup>

Designed primarily to perform traditional regulatory functions, FCC has been dominated professionally by lawyers, and more recently by economists. To deal with the broad communication issues of the future, FCC would need to greatly enhance the scope of its expertise.

*Option B: Designate an existing executive branch agency, **such** as NTIA, as the lead agency to coordinate communication policy.*

NTIA, housed within the Department of Commerce, is also a likely candidate for coordinating national communication policy. In 1978, Executive Order 12046 established NTIA to “provide for the coordination of the telecommunication activities of the Executive Branch.”<sup>50</sup> NTIA has, itself, proposed this option in its report, *NTIA Telecom 2000*. According to NTIA:

The Executive branch should have the authority to *establish* policy, while the FCC should remain the agency for *implementation* of policy [emphasis in the original].

It should be noted that, if this proposal were adopted, the executive branch and legislative agencies would, in effect, be reversing their traditional roles.

Arguing in favor of this option, NTIA points out that the current organizational structure suffers from an outlook that:

- often tends to be reactive and skewed toward achieving short-term objectives;
- focuses too much on the status quo; and
- is too concerned with balancing particularist interests, rather than with long-range policy planning.<sup>51</sup>

According to NTIA, the present, fragmented decisionmaking process encourages stakeholders to shop around for the policy forum in which they are likely to receive the most sympathetic hearing.<sup>52</sup>

If authority for establishing and coordinating communication policy were to be transferred from FCC to the executive branch, many of these problems, NTIA contends, would be minimized.<sup>53</sup> An executive branch agency, it is argued, can be more proactive than an independent agency. Moreover, it can more successfully bring together a cross-disciplinary depth of skills and command greater acceptance and respect within both the government and the private sector than can FCC, which is circumscribed in this respect by its narrowly conceived regulatory (and increasingly deregulatory) role.<sup>54</sup>

The idea of transferring authority from the independent agencies to the executive branch as a means of enhancing policy coordination is by no means a new one, having been the primary recommendation of a number of Presidential commissions created to analyze the organization of government.<sup>55</sup> One of the most recent was the Ash Council, established by President Nixon in 1969. It criticized the independent regulatory commissions for being neither re-

<sup>49</sup>Seidman, *op. cit.*, footnote 26, p. 156.

<sup>50</sup>47 U.S.C. 151.

<sup>51</sup>NTIA, *op. cit.*, footnote 2, p. 165.

<sup>52</sup>*Ibid.*

<sup>53</sup>*Ibid.*, pp. 167-172.

<sup>54</sup>*Ibid.*, p. 167.

<sup>55</sup>For example, in its report to the Congress, the Brownlow Commission, established under president Roosevelt, recommended that 100 independent agencies, administrations, boards, and commissions be integrated into 12 executive departments. The report was particularly critical of the independent regulatory agencies, characterizing them as the “headless fourth branch of Government.” The First Hoover Commission, set up after the Second World War, made similar recommendations, arguing that the executive branch ought to be reorganized to create an integrated, hierarchical structure with the President as an active manager. So too did the J.M. Landis *Report on Regulatory Agencies to the President Elect*, U.S. Senate, 1960. See, for a discussion, “The Federal Executive Establishment: Evolution and Trends,” Library of Congress, Congressional Research Service, prepared for the Senate Committee on Governmental Affairs, May 1980. See also Ronald C. Moe, “The Two Hoover Commissions in Retrospect,” Library of Congress, Congressional Research Service, Nov. 4, 1981.

sponsive to the public interest nor coordinated with national policy.<sup>56</sup> In its conclusions, the Ash Council contended that the executive branch was too fragmented to effectively coordinate public policy.<sup>57</sup> Arguing against establishing interagency coordinating committees to solve the problems of policy coordination--on the grounds that they would serve only to add another layer of decisionmaking--the Ash Council recommended that the government move away from the rather narrow, constituency-oriented traditional departments towards broader, functional departments, integrating a number of independent agencies in the process. It is important to note, however, that in prescribing the integration of a number of independent agencies, the Ash Council made an exception of FCC. It argued that FCC should remain independent, given the sensitive role that it has played with respect to the mass media.<sup>58</sup>

Although many scholars and administrators have taken issue with the concept of the independent regulatory commission, a number have strongly defended it.<sup>59</sup> Most early advocates of independent regulatory commissions focused on the role of such agencies as administrative expert, separate and untarnished by the political process. This rationale, however, was not long in vogue, becoming overtime a major source of criticism of independent regulatory agencies. More recently, the argument has been made that, instead of being protected from abuse and invidious influences, the commission form helps to assure that different views will be taken into account at the highest agency level.<sup>60</sup> Moreover, it is claimed that, although the need to compromise at this level may delay the decisionmaking process, the benefits

may be greater than the costs. As Robinson has noted in this regard:

Differences among agency members do not exist in a vacuum; they reflect basic conflicts among different groups and interests involved in a particular problem. Such conflicts cannot be resolved simply by administrative fiat and attempts to do so are likely only to shift political pressures to Congress (most often congressional committees) or the executive ("White House staff") where they may be equally effective, but less visible to the public.<sup>61</sup>

Just as NTIA opposes delegating the authority for coordinating U.S. communication policy to FCC, so it can be anticipated that FCC would strongly oppose any transfer of its authority to the executive branch. Members of congressional committees responsible for FCC oversight, who in the past have assiduously protected their prerogatives in this regard, are also likely to oppose such a measure.<sup>62</sup> In fact, as Robinson has pointed out, given the historical litany of complaints against independent regulatory commissions, their continued longevity in the face of such criticism attests to the strength of congressional and stakeholder opposition to any change.<sup>63</sup>

Stating the case for Congress and FCC, there are a number of arguments that might be made against such an option. For example, there is the recommendation of the Ash Council that, given FCC's special role, it be exempt from integration into the executive branch. According to the Council's report, in an area as sensitive as communication, a single administrator would be in an "exceptionally vulnerable position which, because of its appearances, could impair public trust," whereas a "collegial form increases the

<sup>56</sup>A New Regulatory Framework: Report on Selected Independent Regulatory Agencies," The President's Advisory Council on Executive Organization, 1971. For a discussion, see Moe, *op. cit.*, footnote 31; see also Harvey Mansfield, "Reorganizing the Federal Executive Branch: The Limits of Institutionalization," *Law and Contemporary Problems*, vol. 35, Summer 1970, pp. 460-495.

<sup>57</sup>Moe, *op. cit.*, footnote 31, p. 33.

<sup>58</sup>The President's Advisory Council on Executive Organization, *op. cit.*, footnote 56, pp. 31-46.

<sup>59</sup>See, for example, Louis Jaffe, "The Effective Limits of the Administrative process: A Reevaluation," *Harvard Law Review*, vol. 67, May 1954, pp. 1105-1135; Henry J. Friendly, "A Look at the Federal Administrative Agencies," *Columbia Law Review*, vol. 60, April 1960, pp. 429-446; and Glen O. Robinson, "Reorganizing the Independent Regulatory Agencies," *Virginia Law Review*, vol. 57, September 1971, pp. 947-995.

<sup>60</sup>*Ibid.*, p. 961.

<sup>61</sup>*Ibid.*, p. 962.

<sup>62</sup>As Moe has pointed out: "Congress is not well organized to deal with abstract principles, such as a unified executive branch. The committee structure is more appropriate for dealing with specific problem areas and with distinct units within the executive branch . . .

Given its constitutional power to establish units in the executive branch, and given its institutional tendency to seek influence in the making of agency policy, Congress increasingly has been inclined to create agencies which have a high degree of independence from Presidential supervision." *Op. cit.*, footnote 37, p. 12.

<sup>63</sup>Robinson (cd.), *op. cit.*, footnote 33.

probability that internal checks and balances will be effective” against otherwise improper influences or biases.<sup>64</sup>

A number of NTIA’s claims about the benefits of reorganization might also be questioned. In *NTIA Telecom 2000*, for example, the assumption is made that an executive branch agency can play a more holistic role than FCC in developing and coordinating communication policy, being less susceptible to the pressures and influences of narrow interest groups. However, challenging the Ash Council’s premise that the President’s broad national constituency would protect an executive branch agency against narrow industry pressures and influences, Robinson has noted:

As a **priori theory**, the idea has appeal. Unfortunately, however, it does not have a very solid anchor in reality insofar as it assumes that executive departments operate majestically above the interests of particular industries or clientele concerns—an assumption which cannot survive the most cursory scan of executive agencies. In fact the phenomenon of interest group representation is very much a part of the basic character of the political process in this country.<sup>65</sup>

Equally questionable is the NTIA assumption about the limited resources and expertise available to FCC. This assumption discounts the fact that Congress could very well enhance FCC’s mandate and provide it with additional resources, as it would have to do if it designated policymaking and coordinating authority to an executive branch agency. The corollary to this assumption—that FCC’s authority is likely to be circumscribed further in the future, given continued deregulation—is also specious, insofar as support for further deregulation is clearly not a given. This is well illustrated by the recent efforts of a number of congressmen to codify the Fairness Doctrine, and by the recent congressional and State debates over price caps and rate-of-return regulation.

Just as FCC resources and staff would need to be upgraded in order for the agency to play a greater national policymaking or coordinating role, so too would those of NTIA. There is little evidence to suggest that, since the coordinating and policy planning functions of the now defunct Office of Telecommunications Policy (OTP) were transferred to NTIA in 1977, progress has been made in developing a coherent and consistent national communication policy. In fact, one could strongly argue the opposite case, given the radical differences in policy perspectives exhibited by different government agencies, as in the case, for example, of the line-of-business restrictions. Nor has NTIA been particularly successful in performing the former OTP task of coordinating the U.S. communication policy position for presentation in international policy fora.

The possibility of NTIA gaining future support to effectively play an enhanced policy role may, moreover, be seriously in doubt. It has recently been proposed, for example, that NTIA be further integrated into the Department of Commerce as part of the Technology Administration, under a new secretary.<sup>66</sup> Were this organizational change to take place, it would be even more difficult for NTIA to reconcile national goals, since it is more likely that commercial criteria would prevail.<sup>67</sup>

*Option C: Establish a new executive agency to address communication issues.*

Over time, organizations develop a “mystique” of their own that affects how the public, other agencies, and Congress relate to them,<sup>68</sup> Moreover, once established, the character of an organization is extremely difficult to change, often requiring—as mentioned above with respect to both FCC and NTIA—nonorganizational measures that expand an agency’s constituency, the complete reconfiguration of administration systems, and a different mix of

<sup>64</sup> Ash *Council Report*, p. 41, as cited in Robinson, *op. cit.*, footnote 59, p. 963.

<sup>65</sup> *Ibid.*, p. 956.

<sup>66</sup> The legislation that authorized this restructuring was passed in the 100th Congress, shortly before its adjournment. Under the proposed reorganization, the National Institute of Standards and Technology (previously the National Bureau of Standards), the National Technical Information Services, and the Office of Productivity, Technology, and Innovation would be combined with NTIA to form the Technology Administration. “Commerce’s Restructuring Plan,” *Broadcasting*, Nov. 14, 1988.

<sup>67</sup> It should be noted, in this regard, that the Department of Commerce was deliberately established to advocate business interests.

<sup>68</sup> Seidman, *op. cit.*, footnote 26, p. 25.

professional skills.<sup>69</sup> Keeping these factors in mind, it could be argued that—given the numerous problems experienced with the previous organization arrangements for dealing with communication policy, and the growing national importance of communication issues—the time is right to create an executive agency specifically designed to deal with communication policy.

In taking such a step, however, caution is required. As Seidman has admonished:

The *first* organization decision is crucial. The course of institutional development may be set irrevocably by the initial choice of administrative agency and by the way in which the program is designed. Unless these choices are made with full awareness of environmental and cultural influences, the program may fail or its goals may be seriously distorted.<sup>70</sup>

Depending on the degree of prominence that Congress wants to attach to such a mission, an agency might be structured as an independent executive agency (like the Environmental Protection Agency or the Small Business Administration) or as a Cabinet-level department.<sup>71</sup> Cabinet-level departments represent the traditional form of executive branch agency that existed up until 1860. Typically, they were directed by a single administrator, who formed part of the President's Cabinet. Today, there are 14 departments at this level.

Executive agencies residing outside the departmental structure were rare until the turn of the 20th century, becoming increasingly prominent after the First World War. Their growth parallels, in a sense, the growing complexity of society. Many independent agencies were established in response to the lobbying pressure of a particular constituency. Examples are the Departments of Agriculture, Labor, and Education (which later became Cabinet-

level agencies). Others, such as the Environmental Protection Agency, were created, in part, as a symbolic gesture to give prominence to a particular national concern.<sup>72</sup>

Since both kinds of agencies can constitute major institutional entities—wielding considerable operational authority and having at their disposal sizable financial and staff resources—the most important factor that distinguishes them from one another is their approximation to the President, and hence their national prominence and relationship to the administration's overall policy program. Separating them, but to a lesser extent, is the fact that tenure is less assured in the case of independent executive branch agencies. In making a choice between these two organizational approaches, therefore, the two most important questions that need to be asked are: 1) How fundamental are the communication-related changes that are taking place within society, and 2) how permanent are they? To the extent that these changes are believed to be enduring, and in order to link together a whole range of societal issues, they might best be treated at the Cabinet level where conflicts can be resolved by the President.<sup>73</sup> On the other hand, if these changes, and the issues to which they give rise, are limited in time and can be treated in a more isolated fashion, an independent agency might be a more appropriate choice.

As noted above, the virtues of the executive-branch form of organization have long been touted by a number of scholars and commissions on governmental organization. Among the advantages typically cited are: enhanced policy coordination, greater efficiencies in division of responsibility and the execution of tasks, greater accountability, and greater ability to attract high-quality personnel.

Regardless of the merits of this option, establishing an executive department is far from simple. Historically, Congress has not been eager to create

<sup>69</sup>Ibid.

<sup>70</sup>Ibid., p. 25. See also Simon et al., op. cit., footnote 28.

<sup>71</sup>A characterization of the Federal executive establishment appears in Title 5 of the United States Code in sections 101-105. ¶% Harold Seidman has pointed out, there are no general Federal laws that define the particular form or organizational structure of Federal agencies. Rather, each agency is defined by the powers enumerated in its enabling actor set forth by executive order. Seidman, op. cit., footnote 26, p. 246. For a description of the wide-ranging variety of executive branch agencies, see also CRS, op. cit., footnote 55.

<sup>72</sup>For a discussion, see Seidman, op. cit., footnote 26, pp. 233-234, and CRS, op. cit., footnote 55, pP. 29-31.

<sup>73</sup>The Bureau of the Budget reserves departmental status for "those agencies which: 1) administer a wide range of programs directed toward a common purpose of national importance; and 2) are concerned with policies and programs requiring frequent and positive presidential direction and representation at the highest levels of Government."



new departments, often requiring an agency to serve a period of apprenticeship before being promoted to the status of an executive department. For example, although a bill to create a Department of Transportation was introduced in Congress as early as 1890, it took 60 years for such a department to be established.<sup>74</sup>

The reluctance of Congress to establish new agencies is not surprising, given the close interrelationships between the executive and legislative branches. Any major changes in the executive branch are likely to have considerable impacts on the distribution of power and responsibility in Congress. Thus, Congress has the ultimate say with respect to any significant organizational changes.

The States also might look askance at the creation of a Department of Communication. As early as 1789, they were concerned that the growth of the executive branch would take place at the expense of their own authority and policymaking prerogatives. For this reason, the States opposed the establishment of both the Department of the Interior in 1849 and the Department of Education in 1970.<sup>75</sup> Given this history, and the number and intensity of recent disagreements between the Federal and State Governments about communication policy, the States might very well be averse to setting up an executive agency for communication.

A number of other stakeholders are likely to be ambivalent about creating anew agency to deal with communication policy issues. Although many may be frustrated by the lack of consistency and coherence in the present situation, they have learned how to operate effectively within it. The establishment of a new agency would be fraught with uncertainty. Since Federal agencies have often served to promote certain constituencies, many would oppose or favor an executive-branch agency depending on whether

they perceive it to enhance or detract from their particular interests.

*Option D: Establish an agency within the Executive Office of the President (EOP) to develop a comprehensive communication policy and coordinate the activities of existing communication agencies.*

While the option of creating an independent executive agency would provide the President with considerable control over communication policy through the powers of appointment, the President's influence would be even greater if the responsibility and authority for developing and coordinating communication policy were located right at the center, in the White House office within EOP.

EOP was established in 1939 as the principal management arm of the President, which would serve to enhance the President's ability to develop comprehensive national policies. Originally housed within it were the White House office, the Bureau of the Budget, and the National Resources Planning Board.<sup>76</sup> Over the years, not only has EOP grown both in terms of personnel and responsibilities; in addition, the White House office has become the key agency within it.<sup>77</sup>

Given the growing importance of the White House office and its close relationship to the President, how one views the option of creating a communication agency to be part of it will depend, to a considerable degree, on one's views about the appropriate roles of, and relationships between, Congress and the executive. It might be noted that, had this option been available at the time of President Andrew Jackson, he would most likely have favored it, being an outspoken advocate of a strong executive. His views on this subject can still serve to illustrate the major rationale for centralizing

<sup>74</sup>Seidman, *op. cit.*, footnote 26, p. 246.

<sup>75</sup>*Ibid.*, p. 16.

<sup>76</sup>CRS, *op. cit.*, footnote 55, p. 24.

<sup>77</sup>*Ibid.* In fact, EOP became so prominent that many, even among those who had advocated its expansion, were becoming concerned about an "institutionalized" presidency.

The growth in the size of the agencies and personnel within EOP also helps to explain the shift in importance towards the White House office staff. As Seidman has noted, their usefulness to the President as a general staff decreased in inverse relationship to their size. Seidman, *op. cit.*, footnote 26, p. 252.

For a recent description of its development up through the Reagan Administration, see Samuel Kernell, "The Evolution of the White House Staff," Chubb and Peterson (eds.), *op. cit.*, footnote 1, pp. 185-237.

the responsibility for communication policy under the direct purview of the President. As he saw it:

[It is the President's] especial duty to protect the liberties and rights of the people and the integrity of the Constitution against the Senate, or the House of Representatives, or both together.<sup>78</sup>

Seidman adds:

As the elected representative of *all* American people, the president alone has the power and responsibility to balance the national interest against the strong centrifugal forces in the Congress for the special interests of subject matter or region.<sup>79</sup>

It was, in fact, this same argument that served as the Nixon Administration's primary rationale for creating OTP within the White House office in 1970. In his message to Congress, President Nixon made it clear that OTP would be a presidential advocate, proposing and arguing for the specific policy preferences of the executive branch.<sup>80</sup> And, decidedly, this was the major role that OTP played during its 8-year existence.<sup>81</sup> It was highly political, did little long-range planning, and was unsuccessful at coordinating national communication policy.<sup>82</sup> Under these circumstances, it is not surprising that OTP was never a particularly popular agency.

Because of its controversial nature, OTP's history illustrates many of the potential problems and advantages that can be associated with this kind of organizational arrangement. In addition, because OTP serves as a precedent, it is possible, to some extent, to look at the way key stakeholders regarded

it and surmise what their attitudes might be to such an institutional option today.

Although located at the center, OTP actually suffered from a lack of power and authority. It enjoyed few resources of its own. While it derived power and influence from the presidency, it was never quite clear to stakeholders when the agency was, in fact, operating on the President's behalf and with the President's authority.<sup>83</sup> Furthermore, having no operational powers, it was totally dependent on other agencies to implement its policies and programs.<sup>84</sup>

Given its inherent organizational weaknesses, the first—and most important—task that OTP faced was to gain legitimacy for its role. This problem was compounded by the fact that few of the traditional government, industry, or political actors had favored the establishment of OTP to begin with. Many felt that it was not legitimate for the White House office to play the role of presidential advocate. And the cast of mind and style of operation<sup>85</sup> of the first OTP Director, Dr. Clay T. Whitehead, did little to assuage their fears. Whitehead strongly believed in the agency's advocacy role. As he described it:

[No one] who's realistic about how government works would expect that an agency could exist in the executive branch, answerable directly to the President, that would not be political in some sense.<sup>86</sup>

Reflecting Whitehead's view of his role, most of OTP's policy decisions were arrived at not through study or analysis, but rather, as Whitehead has

<sup>78</sup>Quoted in Clinton Rossiter, *The American Presidency* (The New American Library, Inc., 1956), p. 92, from Seidman, op. cit., footnote 26.

<sup>79</sup>Seidman, op. cit., footnote 26, p. 72.

<sup>80</sup>See President Nixon's message to Congress in U.S. Congress, House Committee on Government Operations, *Reorganization Plan No. 2 of 1970*, pp. 34.

<sup>81</sup>For a discussion, see James Miller, "The President's Advocate: OTP and Broadcast Issues," *Journal of Broadcasting*, No. 3, Summer 1982, pp. 625-639; and James Miller, "Policy Planning and Technocratic Power: The Significance of OTP," *Journal of Communication*, vol. 32, No. 1, Winter 1982, pp. 53-60. As part of his reorganization plan, which called for a reduction in the size of government, President Carter disbanded OTP upon coming into office in 1978, and transferred the majority of its responsibilities to NTIA.

<sup>82</sup>Ibid.

<sup>83</sup>Miller, op. cit., footnote 81, p. 632.

<sup>84</sup>Ibid.

<sup>85</sup>Reflecting on Whitehead's highly politicized, personal style, Richard Wiley, former chairman of the FCC, recounts how Whitehead stated publicly that: "Broadcasters had duty to avoid 'ideological plugola' in their newscasts and to correct situations where so-called professionals . . . dispense elitist gossip in the guise of news analysis." Richard E. Wiley, "'Political' Influence at the FCC," *Symposium: The Independence of Independent Agencies*, *Duke Law Journal*, April/June 1988, Nos. 2 & 3.

<sup>86</sup>As cited in Miller, op. cit., footnote 81, p. 635.

himself described it, through brainstorming sessions of the agency's director and its chief counsel.<sup>87</sup>

Congress, in particular, was worried about the role of OTP.<sup>88</sup> Never enthusiastic about the agency, Congress's attitude towards and relationships with OTP only deteriorated over time. Representative Herbert Macdonald, Chairman of the House Subcommittee on Communications, was particularly hostile, characterizing the agency in 1971 as "headline grabbers" who use "dramatic proposals and catch phrases" to win favor with one group and scare others, thereby "perpetuating a cruel hoax on the public by suggesting that difficult problems have simple solutions."<sup>89</sup> Reflecting its suspicion and hostility, Congress, in 1975, made significant cuts in OTP's budget. And Senators Weicker and Ribicoff introduced legislation to abolish OTP entirely.<sup>90</sup>

The history of OTP suggests that an agency such as this, located so close to the President, may find it extremely difficult to simultaneously play the roles of both advocate and coordinator. Moreover, it illustrates—perhaps all too painfully—the public administration axiom that to resolve policy conflicts it is not enough to simply create a new organizational arrangement. Finally, the experience of OTP reinforces the notion that the success of any organization will depend, to a significant degree, on the factors and circumstances that led to its creation, and by the particular organizational personality that it projects to the public at the outset.

It is unclear whether a new agency, such as OTP, would be more successful in gaining political support and serving as the primary agency responsible for developing and coordinating communication policy today. Even if it were to play less of an advocacy role, it would still face the problem of having extremely limited resources. To the extent that additional resources were made available to

provide the agency with some operational authority, it could be argued that it would be too large and cumbersome to operate effectively as part of the White House staff or even EOP.<sup>91</sup> One might also question whether it would be wise to locate the expertise for establishing communication policy within an agency that is subject to the change of administrations and the subsequent replacement of key personnel. Seidman notes:

The President ought to have the capability to adapt the Executive Office to his perceived needs, but he should not be permitted in the process to ignore the needs of future presidents, the Congress, and the people.<sup>92</sup>

***Strategy 3: Provide an interagency and/or interjurisdictional mechanism for coordinating communication policy and resolving jurisdictional issues.***

Strategy 2, as described above, would suggest that effective coordination of conflicting communication goals and interests can best be achieved within the organizational context of a single agency. Some public administration scholars would strongly support such a proposition. James D. Mooney, for example, has defined coordination as no less than "the determining principle of organization, the form which contains all other principles, the beginning and the end of all organized effort."<sup>93</sup> However, others would contend that no ongoing, single organization or agency can address the breadth of problems, or their rapidly changing natures, that the United States faces today—especially as they appear in the realm of communication. To address such problems, it is argued, we need to establish interagency and interjurisdictional mechanisms for coordination. Two options available to Congress for such coordinating mechanisms are discussed below.

<sup>87</sup>Ibid.

<sup>88</sup>It should be noted, in this regard, that Congress has never allowed the president to have a free hand in organizing the EOP. As Seidman has pointed out: "Most department heads now have authority to organize and reorganize their agencies without formal congressional approval, but the President lacks comparable power." Seidman, *op. cit.*, footnote 26, p. 248.

<sup>89</sup>Miller, *op. cit.*, footnote 81, p. 635.

<sup>90</sup>Ibid., pp. 633-634.

<sup>91</sup>Forrest Chisman makes this case, for example, in "The Executive Branch," Robinson (ed.), *op. cit.*, footnote 33, ch. 11.

<sup>92</sup>Seidman, *op. cit.*, footnote 26, p. 252.

<sup>93</sup>James D. Mooney, "The Principles of Organization," in Luther Gulick and L. Urwick, *Papers on the Science of Administration* (New York, NY: Institute of Public Administration, 1937), p. 93.

*Option A: Establish an interagency coordinating body with representatives from all agencies that have responsibility for communication policy.*

Just as the American belief in the value of "expertise" led to the creation of independent regulatory agencies set apart from politics, so it gave rise to agencies that were separate and distinct from one another. The idea was that "single-mindedness" would "quickly develop a professionalism of spirit—an attitude that perhaps more than rules affords assurance of informed and balanced judgments."<sup>94</sup>

However, as the role of government expanded and the kinds of issues and problems with which government had to deal became more and more interconnected, it became increasingly apparent that the traditional organizational criterion of efficiency had to be balanced against the need for coordination. No agency had **at its** disposal all of the tools and expertise necessary to deal with major social and economic problems in a comprehensive and coordinated fashion.<sup>95</sup>

One way of trying **to** balance the dual requirements of coordination and efficiency—although never popular or very successful—was to create interagency coordinating committees. Characterizing this form of arrangement, Seidman says:

Interagency committees are the crabgrass in the garden of government institutions. Nobody wants them, but everyone has them. Committees seem to thrive on scorn and ridicule, and multiply so rapidly that attempts to weed them out appear futile.<sup>96</sup>

But, as Seidman is quick to add: "The harshest critics have yet been unable to devise satisfactory substitutes."<sup>97</sup>

Today, two intergovernmental agencies are concerned with communication and communication-related issues: The Senior Interagency Group on International Communication and Information Policy,<sup>98</sup> which was established by the **National** Security Council in 1984, and the Economic Policy Council, which, although it does not directly focus on communication issues, provides an interagency forum for addressing them.<sup>99</sup>

Given the growing importance of communication, and hence the need for greater agency coordination, it is likely that proposals will continue to be made to create interagency mechanisms for coordination. Before adopting any such measures, however, it is wise to consider the extent to which, and the reasons, such organizational forms have so often failed to meet their creators' objectives.<sup>100</sup>

Some of the problems associated with interagency coordinating committees are that they tend to:

- . bury problems rather than resolve them;
- . make it difficult to get tasks accomplished because too many people with only a peripheral interest become involved;
- . dilute interest in, and commitment to, addressing a problem; and
- . lead to outcomes that are based more on the distribution of power within a committee than

<sup>94</sup>James Landis, *The Administrative Process*, (New Haven, CT: Yale University Press, 1938).

<sup>95</sup>Lloyd N. Cutler and David R. Johnson, "Regulation and the Political Process," *The Yale Law Journal*, vol. 84, No. 7, June 1975, pp. 1403-1409.

<sup>96</sup>Seidman, *op. cit.*, footnote 26, p. 207.

<sup>97</sup>Id., ~211; **as noted above**, the Ash Council concluded that such agencies **only serve** to add an **additional** layer of **bureaucracy**. s= also Alan Schick, "The Coordinating Option," in Peter Szanton, *Federal Reorganization: What Have We Learned?* (Chatham, NJ: Chatham House Publishers, Inc., 1981), ch. 5.

<sup>98</sup>Comprised of 16 agencies, the Interagency Group is not a **standing body**; rather, it **meets** when issues **arise**. **The main purpose** of **this group** is to "examine proposed international telecommunications and information policy alternatives from a **full** range of perspectives." It is chaired by the head of NTIA and the Undersecretary of State for Security Assistance, Science, and Technology. NTIA, *op. cit.*, footnote 2, p. 173.

<sup>99</sup>President Reagan set up the Economic Policy Council in 1985 as a means for working out interagency economic policy issues. A Cabinet-level body, it is comprised of the Secretaries of the Treasury, Commerce, State, Energy, Agriculture, and Labor; the Director of the Office of Management and Budget; the U.S. Trade Representative; and the Chairman of the Council of Economic Advisors. The Vice President and the Chief of State are **ex-officio** members, and the heads of nonmember departments maybe invited to attend when **issues germane** to their activities are under discussion. *Ibid.*

<sup>100</sup>It is **interesting t. note**, i, **this regard**, that even thou@ **the problems of interagency committees are well known**, such committees **continue to be** established. President Carter, for example, **planned** to reduce the number of these committees as part of his reorganization efforts. Instead, however, during one 12-month period, he established seven such committees by **executive** order, Schick, *op. cit.*, footnote 97, pp. 95-96.

on policy considerations.<sup>101</sup>

Turning again to the work of Harold Seidman, it is evident that many of the problems that interagency committees have experienced have been due not so much to the particular organizational form they take, but rather to the fact that expectations of what interagency committees can reasonably accomplish have generally been much too high.<sup>102</sup> Although called on to coordinate, these committees all too often are actually expected to develop a policy consensus—a task much more easily said than done. For, if the chairman of an interagency committee actually had power to bring about a consensus, he or she would enjoy more authority than the President, himself.<sup>103</sup> On the contrary, chairmen of interagency committees often have very little authority. When these committees are established, it is generally well understood and agreed upon in advance that the power relationships among the members will remain the same.<sup>104</sup>

Given this tendency to delegate responsibility without equivalent authority, it would appear that interagency committees are likely to be most successful when they are assigned realistic tasks. In addition, these tasks should be related to some overall shared goal—one that is agreed upon at the outset and which, over time, can sustain an organizational commitment. Alan Schick has noted that:

Interagency committees cannot succeed as organizational orphans. When nobody has a vested interest in the group's work and nobody is responsible for following through on its decisions, a committee will languish even if its formal status remains intact.<sup>105</sup>

From the point of view of existing stakeholders, any proposed new interagency coordination can be expected to generate some strong opposition. As Seidman has noted, efforts at coordination are not designed to make friends. For “coordination is rarely

neutral,” and always “advances some interests at the expense of others.”<sup>106</sup> Thus, any proposal to enhance coordination is likely to be judged less on its merits than on how it might redistribute power among existing players.

While Congress has been willing to grant the executive branch considerable leeway in establishing interagency coordinating committees, it too is likely to judge such a proposal on the basis of how it might affect the distribution of power within the legislature. In the past, Congress has been most inclined towards those standing committees that operate similarly to independent agencies, and the most opposed to those that are closely associated with the executive branch and might tend to become “superagencies.”<sup>107</sup>

Given the limitations of interagency coordinating committees, this analysis would suggest that while such committees might contribute to addressing the existing problem of coordinating communication policies, they could do little to resolve this problem on their own. At present, there is neither agreement on overall communication policy goals, nor agreement among agencies as to which group should take the lead in developing such a consensus.

*Option B: Establish an ongoing Federal/State agency, along the lines of the Federal/State Boards, to coordinate and resolve Federal/State interjurisdictional communication policy issues.*

Although a critical and enduring facet of American government, the concept of federalism has evolved over time and in response to changing events and circumstances.<sup>108</sup> The colonial period and the experience of the Revolutionary War gave rise to the notion of a “dual federalism,” which presupposed that the Federal and State Governments

<sup>101</sup>*Ibid.*, p. 95; and Cutler and Johnson, *op. cit.*, footnote 95.

<sup>102</sup>Seidman, *op. cit.*, footnote 26, p. 216.

<sup>103</sup>*Ibid.*

<sup>104</sup>*Ibid.*, pp. 213-216.

<sup>105</sup>Schick, *op. cit.*, footnote 97, p. 97.

<sup>106</sup>Seidman, *op. cit.*, footnote 26, p. 205.

<sup>107</sup>*Ibid.*, p. 222.

<sup>108</sup>For three rather different perspectives on American federalism, see, for example, Michael D. Reagan, *The New Federalism* (New York, NY: Oxford University Press, 1972); Ira Sharkansky, *The Maligned States: Policy Accomplishments, Problems, and Opportunities* (New York, NY: McGraw Hill Book Company, 1972); and David B. Walker, *Towards a Functioning Federalism* (Cambridge, MA: Winthrop Publishers, Inc., 1981).

operate in their own spheres, independently of one another, with each deriving its authority from the people.<sup>109</sup> In the post-World War I and World War II periods, a growing Federal involvement in more and more economic and social activities gave rise to the notion of a “creative” or more integrated federalism. Comparing the latter to the former of these two forms, Grodzins notes, for example:

American federalism is not like a layer cake, with each level of government having its own autonomous sphere of decision making; rather, it is like a marble cake, in that decisions regarding a particular function are made at all levels of government and that all levels typically cooperate in implementing public policies.<sup>110</sup>

It should be noted, however, that if creative federalism is to work in practice, either:

- the States and the Federal Government will need to be in basic agreement about policy goals, or
- the Federal Government will need to have some form of leverage (such as Federal funding) over the State Governments that allows it to impose its point of view.

At present, neither of these conditions exists with respect to communication policy. As noted above, in a number of instances the States have been emphatically opposed to the direction Federal communication policy has taken. Moreover, given the Supreme Court’s decision in the case of *Louisiana v. FCC*, it would appear that the ease with which the Federal Government has been able to preempt State communication policy in the past will, in the future, be quite severely checked. Under these circumstances, it may be necessary to create an ongoing organizational

entity to help resolve Federal/State, and State/State communication policy issues.

One model that might be followed in setting up such a organization is that of the Federal/State boards, presently in use by FCC and State public utility commissions. These boards consist of three FCC commissioners and four State commissioners nominated by the National Association of Regulatory Utility Commissioners (NARUC).<sup>111</sup> They meet to consider divisive State-Federal issues in much the same way that collective bargaining representatives attempt to negotiate an acceptable contract. When a compromise has been reached, both groups attempt to convince their respective groups to support that compromise. At present there are three joint boards dealing with issues related to pricing of telephone services.<sup>112</sup>

According to most participants, the joint board process has been quite useful.<sup>113</sup> Given the anticipated growth and increased intensity of jurisdictional issues, Congress may want to take steps to extend and enhance these institutional arrangements. At present, boards meet on an ad hoc basis at the initiative of FCC. One way in which Congress might strengthen their role, therefore, is to provide the necessary staff and financial resources to allow them to operate on a continual basis. In addition, Congress might authorize the States, as well as FCC, to set the agenda for discussion. Were a joint Federal/State board to exist on a standing basis, Congress might also refer issues to it for an appropriate airing.

Although States might very well favor such an option, having consistently called for a greater State role in Federal communication policymaking,<sup>114</sup> it is likely that FCC would not. In recent public state-

<sup>109</sup>Reagan, *op. cit.*, footnote 108, ch.1.

<sup>110</sup>Morton Grodzins, “The Federal System,” president’s Commission on National Goals, *Goals for Americans* (Englewood Cliffs, NJ: Prentice-Hall, 1960), as cited in Reagan, *op. cit.*, footnote 108, p. 6.

<sup>111</sup>The joint board process was codified by Congress in 1971, after the process had been used successfully by the States and the FCC to resolve a thorny issue in 1970. It is a slight modification of the State joint boards introduced by the Interstate Commerce Commission, which attempted to resolve interstate disputes by convening meetings attended by an equal number of representatives from each of the multiple States affected by a matter. Public Law 92-131, codified at 47 U.S.C. 410 (c). For a discussion, see 1971 *U.S. Congress and Administrative News*, pp. 1513-1514. See also, 49 U.S.C. 10341-1-0344 and accompanying historical references.

<sup>112</sup>Personal communication with Ron Choura, staff member of the Michigan State Utility Commission and senior joint board staff member, Feb. 16, 1989. NARUC has been sufficiently pleased with the process that it has made about 19 requests for issues to be discussed by joint boards in the last 10 years. *Ibid.*

<sup>113</sup>Richard Schultz, “Two-Tier Regulation and Joint Boards in American Telecommunications,” unpublished manuscript, July 1987.

<sup>114</sup>Mark Rockwell, “States Seek More FCC Input, But Patrick Stands Ground,” *CommunicationsWeek*, Nov. 7, 1988, pp. 6, 61.

ments, the FCC Chairman has admonished States for standing in the way of Federal communication policy.<sup>115</sup> Moreover, under present rules, FCC can not move forward on any issue so long as it is being considered by a joint board. Thus, if States could put items on the agenda, they might use this authority to block distasteful policies. On the other hand, if only FCC can establish the agenda, the boards are not likely to delve into fundamental or high-priority issues.

**Strategy 4: *Establish an institutional basis for facilitating coordination and cooperation among government agencies, industry providers, and communication users.***

*Option A: Encourage or support the establishment of advisory bodies to provide input to executive agencies and the FCC on specific communication issues.*

Federal agencies have often set up advisory boards as a way of channeling public input into the administrative process. However, one problem that has typically emerged with these groups is that, over time, many have become somewhat rigid in their makeup. Thus, instead of fostering a broad public input into the policymaking process, some advisory groups have actually served to limit participation and the scope of the policy debate. Moreover, because many of these advisory bodies have appeared at times to have a life of their own, they have often been criticized for not being accountable to the public and being removed from the political process.

In recognition of these problems, Congress passed the Federal Advisory Committee Act in 1972 as an appendix to Title 5 of the U.S. Code.<sup>116</sup> This act required that administrative advisory committees be

held more accountable to Congress, that meetings be open, and that membership be more representative of a broader range of views.

As noted above, a number of advisory committees have already been established to address communication issues, such as the ISDN User Forum in the National Institute for Standards and Technology (NIST) and the Advisory Committee on Advanced TV setup by FCC. FCC has also instigated the ONA process, requiring that regional Bell holding companies develop their ONA plans with the participation of user groups. To further encourage this kind of public input, Congress might promote the development of additional groups to address issues such as telecommunication competitiveness, security and survivability, and the delivery of broadband services to the home. Moreover, to assure that a broad range of considerations are taken into account, it might formalize the existence of such groups under the Federal Advisory Committee Act.

*Option B: Provide for alternative means of dispute resolution in FCC proceedings.*

Some Federal agencies, especially those involved in environmental regulation and labor issues, have been experimenting successfully with new means of dispute resolution as alternatives to the traditional agency procedures for resolving conflicts.<sup>117</sup> Alternative means of dispute resolution (ADR) include negotiated rulemaking, mediation, arbitration, and minitrial.<sup>118</sup>

Negotiated rulemaking, in which an agency convenes a meeting of all interested parties to discuss a specific issue and reach a mutual resolution, has been proposed as an alternative to the traditional regulatory procedure of agency rulemaking, often followed by court challenge.<sup>119</sup> In 1981, the 96th

<sup>115</sup>*Ibid.*

<sup>116</sup>Public Law 92-463, 86 Stat. 770, codified at 5 USC, app. 2.

<sup>117</sup>See Henry H. Perritt, Jr., "Analysis of Four Negotiated Rulemaking Efforts," Final Report prepared for the Administrative Conference of the United States, Nov. 15, 1985; Charles Pou, Jr., "Federal Agency Use of 'ADR': The Experience to Date," Center for Public Resources, 1987, reprinted in Administrative Conference of the U. S., *Sourcebook: Federal Agency Use of Alternative Means of Dispute Resolution* (office of the Chairman, 1987), pp. 101-111; Philip J. Harter, "Dispute Resolution and Administrative Law: The History, Needs, and Future of a Complex Relationship," *Villanova Law Review*, vol. 29, No. 6, 1983, pp. 1393-1419.

<sup>118</sup>For a review of these techniques and examples of Federal use, see Administrative Conference of the U. S., *Op. cit.*, footnote 117.

<sup>119</sup>See Philip J. Harter, "Negotiating Regulations: A Cure for Malaise," *The Georgetown Law Journal*, vol. 71, No. 1, October 1982; Note, "Rethinking Regulation: Negotiation As An Alternative to Traditional Rulemaking," vol. 94, *Harvard Law Review*, 1981, p. 1871; Lawrence Susskind and Connie Ozawa, "Mediated Negotiation in the Public Sector," *American Behavioral Scientist*, vol. 27, No. 2, Nov./Dec. 1983, pp. 255-279; and John T. Dunlop, "The Negotiations Alternative in Dispute Resolution," *Villanova Law Review*, vol. 29, No. 6, 1983, pp. 1421-1448.

Congress considered legislation to permit contacts between agency officials and interested parties, in effect allowing agencies and affected parties to develop regulations in private negotiations.<sup>120</sup> In 1982, the Administrative Conference of the United States adopted recommendations outlining when negotiated rulemaking should be used and what procedures should be followed.<sup>121</sup> In the 97th, 98th, 99th, and 100th Congresses, legislation was again introduced to establish a process to facilitate the formation of negotiated rulemaking procedures within Federal agencies. In the 100th Congress, the Negotiated Rulemaking Act (S.1504) passed the Senate, but not the House.<sup>122</sup> It is expected that a similar bill will be reintroduced in the 101st Congress.

FCC appears to be willing to experiment with alternative means of dispute resolution. In 1986, FCC used a mediator/facilitator in the RKO Settlement Process.<sup>123</sup> In this case, FCC's "goal of a mediated comprehensive settlement of litigation relating to all the RKO properties is clearly not achievable."<sup>124</sup> In most instances, parties reached a point at which they were unwilling to negotiate further. Stuart Brotman argues that negotiated rulemaking would facilitate policy resolution at FCC, especially for issues such as must-carry. As he sees it:

Negotiated rulemaking can and should utilize the "good offices" of the FCC to encourage political consensus from the outside. This allows the Commission to focus its efforts on seeking further public comment and improving the substance of a consensus rather than on developing policies likely to be

challenged through subsequent litigation. Moreover, interested parties working together as collaborators rather than as adversaries are more likely to generate useful information that can be utilized in the rulemaking record that the FCC compiles.<sup>125</sup>

Those who favor alternative means of dispute resolution view them as means for minimizing court involvement, reducing the time required to reach settlement, and providing parties to disputes with an opportunity to somewhat informally reach a consensus or compromise solution. Some are skeptical about the process.<sup>126</sup> Others raise issues about the democratic accountability of alternative means of dispute resolution, including how to: provide for public participation; ensure due-process protections; and protect confidentiality and privacy. \*27

*Option C: Establish a government corporation to perform essential communication services for the public.*

While quite foreign to the free-market advocacy style of the American political economy, organizational arrangements that promote collaboration among government, industry, and user interests are quite common in other parts of the world. In Britain, for example, prior to privatization, users were formally represented by the Post Office Users' National Council, established by law in 1969.<sup>128</sup> Since privatization, the Secretary of State has appointed advisory committees in England, Wales, Scotland, and Northern Ireland to provide for articulation of consumer interests to the Office of Telecommunications (OfTel). There are also advi-

<sup>120</sup>Two Senators introduced bills: Senator Roth introduced S. 1609 and Senator Levin introduced S. 1360. Laura B. Weiss, "Reform Plan Would Allow Developing Federal Rules in Private Negotiations," *Congressional Quarterly Weekly Report*, vol. 39, No. 37, Sept. 12, 1981, p. 1758.

<sup>121</sup>Administrative Conference of the United States, Procedures for Negotiating Proposed Regulations, Recommendation No. 82-4, 1CFR 305.82-4, July 15, 1982.

<sup>122</sup>*Congressional Record*, Senate, vol. 133, No. 118, July 17, 1987.

<sup>123</sup>James C. McKinley, *Final Report of the Mediator/Facilitator in the RKO Settlement process* (Report to the Federal Communications Commission, Feb. 3, 1987).

<sup>124</sup>*Ibid.*, p. 3.

<sup>125</sup>Stuart N. Brotman, "Communications Policymaking at the Federal Communications Commission: Past Practices, Future Direction," The Annenberg Washington Program in Communication Policy Studies, December 1987, p. 75.

<sup>126</sup>Marguerite Millhauser, "The Unspoken Resistance to Alternative Dispute Resolution," *Negotiation Journal*, January 1987, pp. 29-35.

<sup>127</sup>Harold H. Bruff, "Constitutionality of Arbitration in Federal Programs," (draft report to the Administrative Conference), Apr. 26, 1987, reprinted in Administrative Conference of the U. S., op. cit., footnote 117, pp. 961-1041; and Note, "Protecting Confidentiality in Mediation," *Harvard Law Review*, 1984, vol. 98, No. 2, pp. 441-459.

<sup>128</sup>The Post Office was obligated to consult the Council, but not required to follow its requests. For a discussion, see Kevin Morgan, "Breaching the Monopoly: Telecommunications and the State in Britain," University of Sussex, Working Papers, Series on Government-Industry Relations, No. 7, January 1987, pp. 3-4.



sory committees for small-business users and for the disabled and pensioners.<sup>129</sup> In Japan, collaboration, an integral feature of its industrial policy, extends even further. Generally, the Ministry of International Trade and Industry (MITI) issues “administrative guidance” to alert large corporations of its plans. Industry, which often employs ex-MITI officials to facilitate its liaison with MITI, usually complies with this guidance.<sup>130</sup> MITI also coordinates with industry through advisory committees and public-and private-sector forums.<sup>131</sup> Large telecommunication users and suppliers lobby the Japanese Government through Keidanren, the Federation of Economic Organizations, and the Communications Industry Association of Japan (CIAJ).<sup>132</sup>

In the United States, on the other hand, such collaboration has been much more limited. Here, the most typical kind of cooperative arrangement between government and the private sector has taken the form of the government corporation.<sup>133</sup> Although there are precedents for this kind of government involvement in the performance of economic activities as far back as 1781 with the establishment of the First Bank of the United States, its popularity has ebbed and flowed, becoming more popular during periods of crisis and emergency.<sup>134</sup> For example, a number of government corporations were established to deal with the problems arising during the

Depression and during the First and Second World Wars, including the Reconstruction Finance Corp., Commodity Credit Corp., and Tennessee Valley Authority.<sup>135</sup>

As in the case of independent regulatory agencies, support for government corporations originally came from those who were suspicious of politics and politicians. Such organizational arrangements were viewed with special favor by those “who wanted government to be ‘run in a more business-like manner.’”<sup>136</sup> Over time, however, the rapid growth and increased autonomy of government corporations began to raise concerns among government administrators<sup>137</sup> and political scientists, who feared that they were no longer accountable to either Congress or the President.<sup>138</sup>

Two government corporations have been established in the realm of communication—the Communications Satellite Corp. (COMSAT) and the Corp. for Public Broadcasting (CPB). COMSAT was, in fact, somewhat atypical, insofar as it was a private for-profit corporation sponsored by the Federal Government. Established by the Communications Satellite Act of 1962, COMSAT was intended to be a carriers’ carrier for the telecommunication industry. While it was designed to take its place in the private sector, COMSAT benefited from certain

<sup>129</sup>John King, “The British Telecom Experience—Transformation of a Public Corporation to a Public Limited Company,” *International Journal of Technology Management*, vol. 1, No. 1/2, 1986, p. 82.

<sup>130</sup>Jill Hartley, “The Japanese Approach to the Development of New Residential Communication Services,” Marjorie Ferguson (ed.), *New Communication Technologies and the Public Interest* (London, England: Sage, 1986), p. 168.

<sup>131</sup>Jill Hills, *Information Technology and Industrial Policy* (London: Croom Helm, 1984), pp. 251-252.

<sup>132</sup>Kas Kalba, “Opening Japan’s Telecommunication Market,” *Journal of Communication*, vol. 38, No. 1, Winter 1988, p. 99; and Jill Hills, *Deregulating Telecoms* (Westport, CT: Quorum Books, 1986), p. 141.

<sup>133</sup>For a discussion, see Ronald C. Moe, Library of Congress, Congressional Research Service, “Administering Public Functions at the Margin of Government: The Case of Federal Corporations,” HD 2755, Dec. 1, 1983. See also Ira Sharkansky, *Whither the State? Politics and Public Enterprise in Three Countries* (Chatham, NJ: Chatham House, 1979); and National Academy of Public Administration, *Report on Government Corporations* (Washington, DC: National Academy of Public Administration, 1981). There is no formal definition of what constitutes a government corporation. The organizational structure of each is defined in its enabling legislation and, hence, these corporations have taken a variety of forms. Concerned that government corporations were becoming unaccountable, and that their growth was getting out of hand, Congress, in 1945, passed the Government Corporation Control Act, which established budgeting and auditing standards. The act provided, moreover, that no corporation be created or acquired by any agency or corporation of the Federal Government without the specific authorization of Congress.

<sup>134</sup>Moe, op. cit., footnote 133, pp. 6-7.

<sup>135</sup>*Ibid.*

<sup>136</sup>*Ibid.*, p. 9.

<sup>137</sup>The Brownlow Commission, while recognizing the value of this form of organizational arrangement, recommended that they be incorporated within existing Federal agencies.

<sup>138</sup>See, for example, Harold Seidman, “Government-Sponsored Enterprises in the United States,” Bruce Smith (ed.), *The New Political Economy: The Public Use of the Private Sector* (London, England: Macmillan Co., 1975).

advantages that this government arrangement bestowed on it.<sup>139</sup>

CPB was established in accordance with the provisions of the Public Broadcasting Act of 1967.<sup>140</sup> Its purpose was to serve as a financial sponsor and catalyst for “public television,” fostering programming for “general enrichment” and educational purposes.<sup>141</sup> The government corporation was selected as the ideal organizational form because it was thought that this kind of arrangement would shield CPB from government and political pressure. Although CPB has been quite effective in generating high-quality programming, it has not been completely successful in deflecting political pressure (as the earlier discussion in ch. 9 concerning the financing of public broadcasting clearly illustrates).<sup>142</sup>

As the United States begins to adjust to the many technological, economic, and social changes taking place in the realm of communication, there may be a role for government corporations in certain areas. For example, just as CPB was established to provide programming that might not be developed in the marketplace, so a government corporation might be

established to provide certain kinds of information services, gateways, and navigational tools. Similarly, just as stabilization corporations were established during the Depression to help farmers and consumers survive the structural changes that were taking place in the economy, so government corporations might be set up today to help small businesses or rural areas, for example, move into the information age. The benefits and costs of adopting this kind of approach have perhaps best been summarized by the National Academy of Public Administration, which was asked by the Office of Management and Budget to examine the utility of government corporations. In its report, it concluded:

Created for an appropriate purpose, organized and managed soundly, operating responsibly within the policies laid down by Congress and the Administration, they (government corporations) are valuable tools of modern government. However, the inappropriate use of the corporate device together with a lack of consistency in exempting such corporations from financial, personnel and other types of controls has led to a host of problems, as has the failure to use the corporate form in situations where it would contribute to the improved management of programs.<sup>143</sup>

---

<sup>139</sup>Moe, *op. cit.*, footnote 133, p. 22; for a discussion, see also Lloyd Musolf, *Uncle Sam's Private, Profitseeking Corporations* (Lexington, MA: Lexington Books, 1983.)

<sup>140</sup>For a discussion, see Robert K. Avery and Robert pepper, “An Institutional History of Public Broadcasting,” *Journal of Communication*, vol. 30, No. 3, Summer 1980, pp. 126-138.

<sup>141</sup>Moe, *op. cit.*, footnote 133, pp. 82-83.

<sup>142</sup>See also *ibid.*

<sup>143</sup>National Academy of Public Administration, *Report on Government Corporations*, vol. 1 (Washington, DC: National Academy of Public Administration, 1981), p. 3.

# Appendixes

## Workshop Participants

---

### Tracking Technology Workshop

Kan Chen  
University of Michigan

Joseph W. Duncan  
The Dun& Bradstreet Corp.

David S. Evans  
Fordham University

John D. Kasarda  
University of North Carolina, Chapel Hill

Joseph Martino  
University of Dayton

Abbe Mowshowitz  
The City College, CUNY

Howard Rheingold  
Journalist

Langdon Winner  
Rensselaer Polytechnic Institute

### Characterizing the U.S. Communication System Workshop

Christopher Burns  
Christopher Burns, Inc.

Donal A. Carbaugh  
University of Massachusetts, Amherst

Deborah Estrin  
University of Southern California

Vincent Mosco  
Carleton University

Daniel T. Schiller  
University of California, Los Angeles

Deborah G. Tumeay  
Citibank, N.A.

## Appendix B

# Reviewers and Contributors

---

Chadwick Alger  
Ohio State University

Ron Alridge  
*Electronic Media*

Fritz E. Attaway  
Motion Picture Association of  
America, Inc.

Pat Aufderheide  
United Church of Christ

Colin Bennett  
University of Victoria

Sanford V. Berg  
University of Florida

Richard K. Blake  
Siemens Communication Systems,  
Inc.

Marjory Blumenthal  
NAS Computer Science &  
Technology Board

Steven A. Bookshester  
National Association of Broadcasters

Walter W. Borton  
Park Communications, Inc.

Nolan Bowie  
Temple University

Sandra Braman  
Rutgers University

Stuart N. Brotman  
Consultant

Dennis J. Brownlee  
Advance, Inc.

Cynthia Brumfield  
National Cable Television  
Association

Ellen Burton  
US WEST, Inc.

John Carey  
Greystone Communications

Carl F. Cargill  
Digital Equipment Corp.

Lisa Carlson  
Metasystems Design Group Inc.

James B. Carpenter  
Southwestern Bell Telephone

James I. Cash, Jr.  
Harvard University

Joseph Chaisson  
Consultant

Bill Chandler  
Consultant

Gary Chapman  
Computer Professionals for Social  
Responsibility

Peggy Charren  
Action for Children's Television

Daryl Chubin  
Office of Technology Assessment

John Clement  
NAS/COSEPUP

Joseph F. Coates  
J.F. Coates, Inc.

Vary Coates  
Office of Technology Assessment

Lawrence P. Cole  
GTE Service Corp.

Kathleen Criner  
American Newspaper Publishers  
Association

Terry Curtis  
California State University, Chico

Bowman Cutter  
Coopers & Lybrand

Larry Darby  
Consultant

Brenda Dervin  
Ohio State University

Wilson Dizard  
Center for Strategic and International  
Studies

Herbert S. Dordick  
Temple University

Aliza Duby  
South African Broadcasting Corp.

Donald Dulchinos  
National Cable Television  
Association

Barry J. Eckhart  
Northern Telecom, Inc.

Steve Effros  
CATA

Martin Elton  
Columbia University

J. D. Eveland  
Technology Applications Research

Richard A. Fazzone  
GE Information Services

Louis Feldner  
Consultant

Robert E. Fischer  
The Mitre Corp.

Susan C. Frary  
MCI Communications Corp.

Warren B. French, Jr.  
Shenandoah Telephone Co.

Oscar H. Gandy, Jr.  
Annenberg School of Communications

Henry Geller  
Duke University

L.J. Gitten  
AT&T Network Systems

Sandra B. Gear  
Presbyterian Church (U. S. A.)

David B. Hack  
Congressional Research Service

Anne Hagemann  
Consultant

Timothy Haight  
*Communications Week*

Mr. Edwin Hall  
MCI

Linda Harris  
U.S. Department of Health & Human  
Services

E. Fletcher Haselton  
Teknekron Infoswitch Corp.

Robert K. Heldman US West Communications	Robert Kraut Bell Communications Research	John T. Morgan Communication Workers of America
Carol Henderson The American Library Association	Todd LaPorte University of California, Berkeley	Kevin Morgan University of Sussex
John T. Herndon Florida Public Service Commission	Stephanie G. Larson The George Washington University	Mitchell L. Moss New York University
Harrison Hickman Hickman-Maslin Research, Inc.	Alfred Lee NTIA	Daryl Nail Florida Public Service Commission
Jill Hills The City University, London	Stanford L. Levin Southern Illinois University at Edwardsville	Dorothy Nelkin Cornell University
C. Lincoln Hoewing Bell Atlantic Network Services Inc.	Jenny Levine MCI Communications Corp.	W. Russell Neuman MIT Research Program on Communications Policy
Glen H. Hoptman National Demonstration Laboratory for Interactive Educational Technologies	Judith Lichtenberg University of Maryland	Jack M. Nines University of Southern California
Richard Horton British Embassy	Robert E. Lloyd Bell Atlantic Network Services, Inc.	Roger G. Nell Stanford University
Robert W. Hubbard Hubbard Broadcasting, Inc.	Jarol B. Manheim The George Washington University	Bill Norris Office of Technology Assessment
David Hughs Chariot Communications	Mary Jo Manning Wilkes, Artis, Hedrick & Lane	P. Michael Nugent Electronic Data Systems Corp.
Charles L. Jackson NERA	Calvin K. Manshio Illinois Commerce Commission	Timothy Nulty The World Bank
Robert Jacobson Consultant	Joseph P. Martino University of Dayton	Bruce M. Owen Economists Inc.
Jennifer Jarrett J.F. Coates, Inc.	Gary T. Marx MIT	Preston Padden INTV
Leland Johnson The RAND Corp.	Elliot Maxwell Pacific Telesis Group	Michael D. Pelcovits MCI Communications Corp.
Nicholas Johnson <i>The New Tech Times</i>	Martin McCue United States Telephone Association	Joseph N. Pelton University of Colorado
Nancy Karen NYNEX	Bruce W. McConnell Office of Management & Budget	David Peyton ADAPSO
Steven Katz People for the American Way	Doreen McGirr U.S. Department of State	Gary L. Pinkham Ericsson Network System
Richard B. Kielbowicz University of Washington	Paul A. Miller Virginia Citizens Consumer Council	G. Russell Pipe Translational Data Reporting Service, Inc.
George Kohl Communication Workers of America	Robert A. Miller GTE Communications	Douglas Pitt University of Strathclyde, Scotland
Melvin Kranzberg Georgia Institute of Technology	George Minot Applied Information Technologies Research Center	Larry Povich FCC
Allen W. Kratz presbyterian Church (U. S. A.)	Newton N. Minow The Annenberg Washington Program	Ward L. Quaal The Ward L. Quaal Co.

George Quester  
University of Maryland

Gordon T. Ray  
NEC America, Inc.

Harold C. Relyea  
Congressional Research Service

Steve Renten  
Pacific Bell

Ronald Rice  
Rutgers University

Henry M. Rivera  
Dow, Lohnes & Albertson

Marsha Ryan  
Ohio Consumer Association

Jeanne M. Schaaf  
Telenet Communications Corp.

Gail Garfield Schwartz  
New York State Public Service  
Commission

Lee L. Selwyn  
Economics and Technology, Inc.

Sanford Sherizen  
Data Security Systems, Inc.

Harry M. Shooshan III  
NERA

Larry Siegel  
IBM Corp.

Mark Sievers  
US Sprint Communications Co.

Samuel A. Simon  
Issue Dynamics, Inc.

Casimir Skrzypczak  
NYNEX

Cathy Slesinger  
NYNEX

Catherine Sloan  
Comptel

Gerald W. Smith  
The University of Utah

Paul Smith  
Wiley, Rein & Fielding

Robert L. Smith, Jr.  
Videotex Industry Association

Oliver Smoot  
CBEMA

Paul Starr  
Princeton University

Christopher H. Sterling  
The George Washington University

Robert E. Stoffels  
Harcourt Brace Jovanovich  
Publications

Camille Stonehill  
State Telephone Regulation Report

Theresa Sullivan  
University of Texas

Mark G. Swank  
U.S. Videotel

Joel Swerdlow  
The Annenberg Washington program

Jacques Tamisier  
Ambassade de France aux Etats-Unis

Paul E. Teske  
Consultant

Elizabeth Thoman  
*Media & Values*

Jane Uebelhoer  
ACORN

Armando Valdez  
Stanford University

Thomas S. Valovic  
*Telecommunications*

Richard Victor  
Harvard University

Philip M. Walker  
Telenet Communications Corp.

Thomas V. Wasilewski  
NTIA

Steve Weatherford  
University of California, Santa Barbara

Frank Webster  
Oxford Polytechnic

Sandra G. Weis  
Prodigy Services Co.

Robert M. Wienski  
Siemens Public Switching Systems,  
Inc.

Rolf Wigand  
Arizona State University

Brian Winston  
Pennsylvania State University

Joan Winston  
Office of Technology Assessment

Patricia M. Worthy  
Public Service Commission of the  
District of Columbia

Susan Yezzi  
NYNEX

Edward Zajac  
University of Arizona

Elia Zureik  
Queen's University

## List of Contractor Reports

---

Copies of the following contractor reports completed in support of this assessment will be available in spring 1990 from the National Technical Information Service, 5285 Port Royal Road, Springfield, VA 22161, (703) 487-4650. The views expressed in these reports are those of the contractors and not necessarily those of OTA, the Technology Assessment Board, or U.S. Congress.

1. Raymond U. Akwule, George Mason University, "Review of the Communications Policies and Practices in Nigeria," July 1987.
2. Stuart N. Brotman, "Integration in Key Communications Industries: Business and Policy Considerations," June 1988.
3. Christopher Burns, Christopher Burns, Inc., "Communications Systems in the United States," December 1986.
4. Donal Carbaugh, University of Massachusetts (Amherst), "Communications Systems: Exploring the Role of Information Technologies," December 1986.
5. Kan Chen, University of Michigan, "Anticipating Changes in Communications Technologies: A System Scientist's Methodology," December 1986.
60. Daniel J. Czitrom, Mount Holyoke College, "Goals of the U.S. Communication System: An Historical Perspective," September 1987.
7. Brenda Dervin, Ohio State University, "Categorization of Communication Users," September 1987.
8. Joseph W. Duncan, The Dun & Bradstreet Corp., "Forecasting Telecommunications Technology," December 1986.
9. Martin Edmonds, University of Lancaster, "Defense Interests and United States Policy for Telecommunications," June 1988.
10. Deborah Estrin, University of Southern California, "Communications Systems for an Information Age: A Technical Perspective," December 1986.
11. David S. Evans, Fordham University and CERA Economic Consultants, Inc., "Economic Aspects of Technological Change in the Communications Industries," December 1986.
12. J.D. Eveland, Technology Applications Research, "Stakeholder Relationships in the Communications System," October 1987.
13. Heather E. Hudson, University of San Francisco, "Communication Policies and Practices: India," July 1987.
14. Richard B. Kielbowicz, University of Washington, "The Role of Communication in Building Communities and Markets: An Historical Overview," November 1987.
15. Richard B. Kielbowicz, University of Washington, "Societal Values That Have Guided the U.S. Communication System: A Short History," August 1988.
16. Vincent Mosco, Carleton University, "The Communications System From a Regulatory Perspective," December 1986.
17. Abbe Mowshowitz, Technology Impact Research Inc., "Communication and Comparative Advantage in the Business Arena: Operations and Technological Development" July 1988.
18. Greta S. Nettleton, "Review of the Communications Policies and Practices of Brazil," July 1987.
19. Howard Rheingold, "New Tools for Thought: Mind-Extending Technologies and Virtual Communities," December 1986.
20. Nathan Rosenberg, Stanford University, "Reflections on the Future of the Telecommunications Industry," December 1986.
21. Daniel T. Schiller, University of California (Los Angeles), "The U.S. Communications Industry in Transition," December 1986.
22. Jennifer Daryl Slack, "Historical Review of the Concept of Communication Needs With Respect to Technology," November 1987.
23. Gerald Sussman, Emerson College, "Communication Systems for an Information Age: Singapore," July 1987.
24. Lucja Swiatkowski, "Communications in Poland," July 1987.
25. Paul E. Teske, "State Regulation of Telecommunications," July 1987.
26. Deborah G. Tumey, Citibank, N. A., "Financial Institutions' Communications Systems," December 1986.
27. Langdon Winner, Rensselaer Polytechnic Institute, "Information Regimes and Political Vision," December 1986.



## Appendix D

# List of Acronyms

---

ADR	—alternative means of dispute resolution	FCC	—Federal Communications Commission
ANI	—automatic number identification	FDDI	—fiber distributed data interface
ANSI	—American National Standards Institute	FRC	—Federal Radio Commission
AP	—Associated Press	GATT	—general agreement on tariffs and trade
AT&T	—American Telephone & Telegraph Co.	GOSIP	-Government Open Systems Interconnection Profile
ATTC	—Advanced Television Test Center	HBO	—Home Box Office
ATS	—Advanced Television Services	HDTV	—high definition television
B-ISDN	—broadband integrated services digital network	IBN	—integrated broadband network
Bellcore	—Bell Communications Research Inc.	IEC	—International Electrotechnical Commission
BOC	—regional Bell operating company	HLC	—Information Industry Liaison Committee
BSA	—basic service arrangement	INS	—information network system
BSE	—basic service element	ISDN	—integrated services digital network
C-SPAN	—Cable Satellite Public Affairs Network	ISO	—International Standards Organization
C3I	-Command, Control and Communications and Intelligence	JTC1	—Joint Technical Committee 1
CAD/CAM	-computer-aided design/manufacturing	LAN	—local area network
CATV	--community antenna television	LATA	—local access and transport area
CBEMA	—Computer Business Equipment Manufacturers Association	LEC	—local exchange carrier
CD-ROM	-compact disk--read only memory	LPTV	—lowpower television
CCITT	—International Telegraph and Telephone Consultative Committee	MAP	—manufacturing automation protocol
CEI	-comparably efficient interconnection	Mbps	—megabits per second
CEPT	-Conference of European Postal and Telecommunications Administrations	MFJ	—Modified Final Judgment
CERT	-Computer Emergency Response Team	MIDI	—musical instrument digital interface
CIAJ	—Communications Industry Association of Japan	MITI	—Ministry of International Trade and Industry
CO-LANs	—central office local area networks	MMDS	—multichannel multipoint distribution system
COMSAT	—Communications Satellite Corp.	N-ISDN	—narrowband integrated services digital network
CPB	—Corporation for Public Broadcasting	NARUC	—National Association of Regulatory Utility Commissioners
CPE	-customer premises equipment	NASA	—National Aeronautics and Space Administration
CLASS	-customer local area signaling service	NCIC	—National Crime Information Center
DARPA	—Defence Advanced Research Project	NCS	—National Communications System
DBS	--direct broadcast satellite	NCTA	—National Cable Television Association
DCA	—Defense Communications Agency	NETS	—Nationwide Emergency Telecommunications Service
DoD	—Department of Defense	NIST	—National Institute for Standards and Technology
DOJ	—Department of Justice	NOAA	—National Oceanic and Atmospheric Administration
DS	-directory services	NRC	—National Research Council
ECMA	—European Computer Manufacturing Association	NSA	—National Security Agency
ECSA	—Exchange Carriers Standards Association	NSF	—National Science Foundation
EDI	-electronic data interchange	NS/EP	—National Security/Emergency Preparedness
EOP	—Executive Office of the President	NSDD-13	—National Security Decision Directive-13
EOSAT	—Earth Observation Satellite Co.	NSTAC	—National Security Telecommunications Advisory Committee
ESPRIT	—European Strategic Programme for Research and Development in Information Technology	NTIA	—National Telecommunications and Information Administration
ETSI	—European Telecommunications Standards Institute	Oftel	-Office of Telecommunications

ONA	-open network architecture	SONET	—synchronous optical network
OTP	-Office of Telecommunications Policy	SS7	—signaling system 7
OSI	-open systems interconnection	SWIFT	—Society for Worldwide Interbank Financial Telecommunications
OSS	-operating support systems	TCP/IP	—transport control protocol/internet protocol
PBX	—private branch exchange	TECS	—Treasury Enforcement Communications System
Pc	—personal computer	TOP	—technical and office protocol
PPV	—pay-per-view	UHF	—ultra high frequency
<b>PTT</b>	—postal, telegraph, and telephone authority	VCR	—videocassette recorder
Puc	—public utility commission	VHF	—very high frequency
RACE	—Research for Advanced Communications in Europe	VISN	—Vision Interfaith Satellite Network
REA	—Rural Electrification Administration	VT	—virtual terminal
RBOC	—regional Bell operating company	WATTC	—World Administrative Telephone and Telegraph Conference
RFD	—rural free delivery		
RHC	—regional Bell holding company		
SDNS	—Secure Data Network Systems		
SNA	—system network architecture		